

S2000 Jr. SERIES

Price Computing Scale



CONTENTS

PRECAUTIONS	4
PREFACE	6
OVERALL VIEW	6
DISPLAY & KEYBOARD	7
OPERATIONS	11
I. Programming Mode	11
Chapter 1. Basic Operation	12
Chapter 2. PLU Saving & Calling-up	15
Chapter 3. User's Set-up Mode	19
Chapter 4. Formatting Printing Receipt	23
II. Sales Mode	30
Chapter 5. Sales Transaction	31
Chapter 6. Daily Total Sales	33
ASCII CODE	35
ERROR MESSAGES	36
SERIAL INTERFACE	36
SPECIFICATION	37

PRECAUTIONS

Warning

Precautions when installing the scale. To ensure that you get the most from your scale, please follow these instruction.

Do not disassemble the scale.

When any damage or defect occurs, contact your CAS authorized dealer immediately for proper repair.



Do not overload beyond the maximum weight limit.

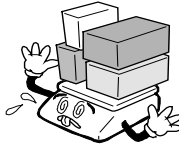

Scale must be grounded to minimize electricity static.

This will minimize defect or electric shock.



Do not pull the plug by its cord when unplugging.

Damaged cord could cause electric shock or fire.



To prevent from fire occurring, Do not place or use the scale near flammable or corrosive gas.

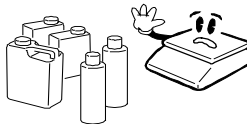

To reduce electric shock or incorrect reading, Do not spill water on the scale or place it in humid condition.

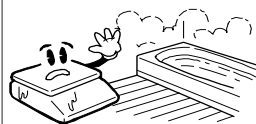

Avoid placing the scale near heater or in direct sunlight.

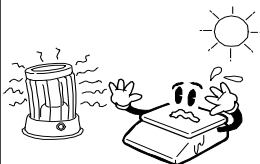

Insert plug firmly to wall outlet to prevent electric shock.

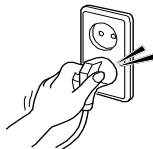

Use proper Adapter.

Incorrect adapter could damage the scale.



Attention

Make sure to plug your scal into the proper power outlet. For maximum performance, plug into a power outlet 30 minutes before the usage for warm up.

For consistent and accurate reading, maintain periodical check by your CAS authorized dealer.



Avoid sudden shock to the scale.



Grab on the bottom of the scale when moving.



Keep the scale away from other electromagnetic generating devices.

This may interfere with accurate reading.



Place the scale on firm and temperature consistent environment.



By adjusting 4 corners of the scale, set the scale even using the built in scale leveling indicator.



Take the battery out when scale is not in use for long time. Leakage from the batteries is hazardous.



PREFACE

Thank you for the purchasing CAS S2000 Jr.
This series have been designed with CAS reliability, under rigid quality control and with outstanding performance. Your specialty departments can enjoy with CAS product. We hope that CAS product meets your needs.
The user manual is designed to guide you to understand product operation and proper care of product.

OVERALL VIEW

■ S2000 Jr.

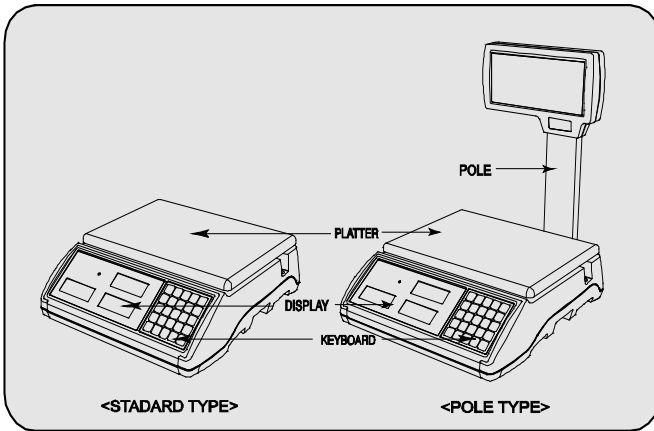

■ S2000 Jr - M

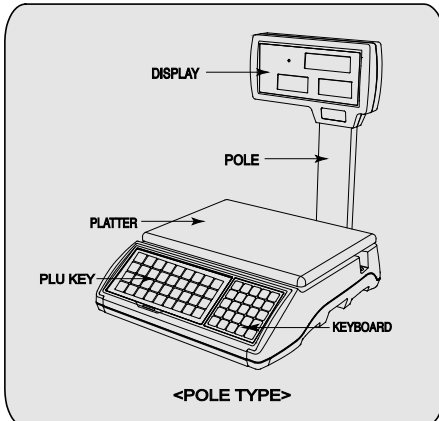

DISPLAY & KEYBOARD

- S2000 Jr. LCD TYPE : Front Display

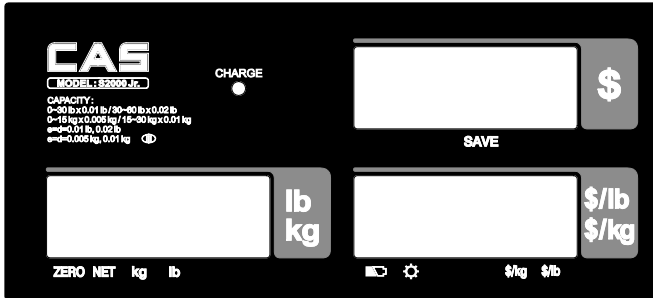

- S2000 Jr. LCD TYPE : Rear Display



- S2000 Jr. VFD TYPE : Front Display

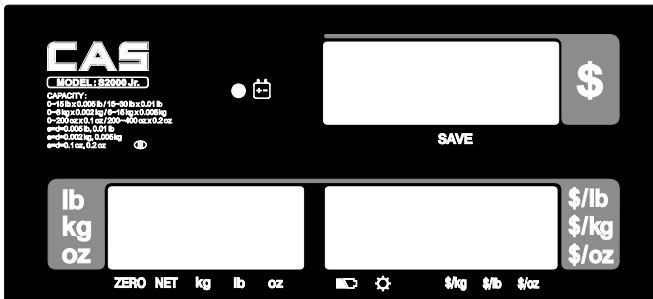

- S2000 Jr. VFD TYPE : Rear Display



■ S2000 Jr. – M LCD TYPE : Front Display

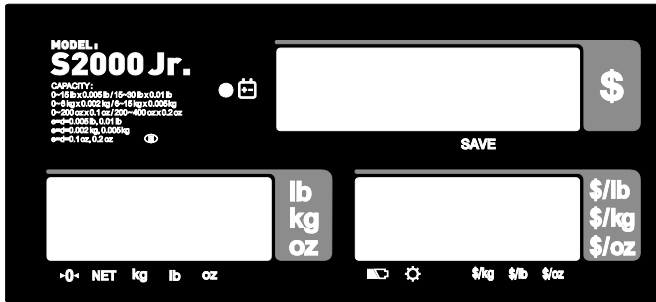

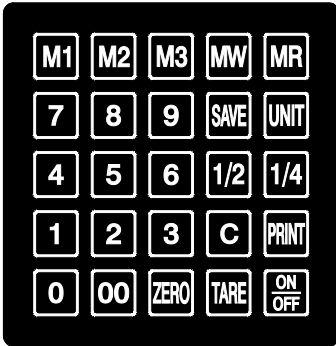

Table : Symbols on Display

SYMBOLS	DESCRIPTION
ZERO (▼)	To adjust zero
NET (▼)	Tare on
kg (▼)	
lb (▼)	
 (▼)	Low battery warning
 (▼)	Back light on
\$/kg (▼)	
\$/lb (▼)	
SAVE (▼)	
CHARGE (▼)	Charge status

■ KEYBOARD



■ ER^{PLUS-M} Direct PLU Key pad

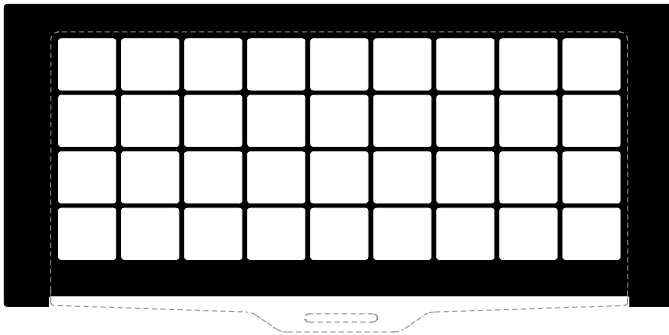

















Table: Key Functions

KEYS	FUNCTIONS
 ~ 	To input all of numerical data
 ~ 	Direct PLU keys
	To save PLU
	To call up PLU
	Used to prevent the auto clearing of unit price and weight both
	
	To clear data
	To set zero
	To set or clear tare value
	To turn on & off the scale
	Used to convert a unit price to a half pound
	Used to convert a unit price to a quarter pound
	Used to print out a label
	Direct PLU key (ER ^{PLUS-M})

OPERATIONS

I. Programming Mode

Chapter 1. Basic Operation

- a. Turning the scale on / off
- b. Turning backlight on / off (Option in LCD version only)
- c. Zero function
- d. Tare function
 - One Time tare
 - Successive tare
 - Preset tare

Chapter 2. PLU Saving & Calling-up

- a. Saving unit price on PLU
- b. Saving tare weight on PLU
- c. Saving valid date set on PLU (Option)
- d. Saving PLU item code
- e. Saving PLU name
- f. Calling up PLU
 - Indirect PLU
 - Direct PLU

Chapter 3. User's Set-up Mode

- a. Auto power-off
- b. LCD backlight ON/OFF function (Option in LCD version only)
- c. Brightness control (Option in LCD version only)
- d. Low battery backlight auto off function (Option in LCD version only)
- e. Suspend Mode Function (Only LED version)
- f. Selecting the printer

Chapter 4. Formatting Printing Receipt

- a. Setting the Printer
- b. Receipt header setting
- c. Receipt currency (unit) setting
- d. Receipt DATE setting
- e. Receipt TIME setting

- 
- f. Receipt Date format setting
 - g. Samples of Print format

Chapter 1. Basic Operation

a. Turning the scale on / off

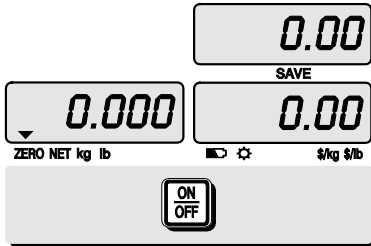

① Press **ON/OFF** key to turn on.

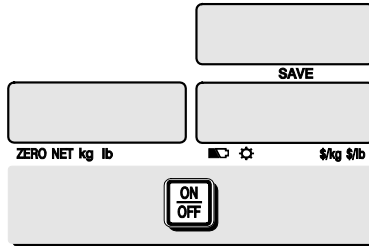

② Press **ON/OFF** key to turn off(LED, VFD Version).
Press **ON/OFF** key for a few seconds to turn OFF(LCD Version)

b. Turning backlight on/off(Option in LCD version only)

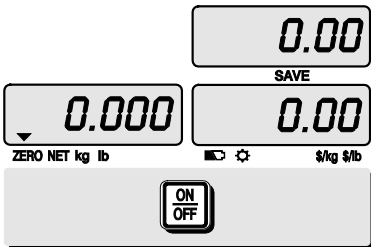

① Press **ON/OFF** key to turn on.

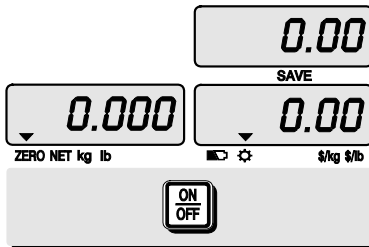

② Press **ON/OFF** key again under the backlight on.

c. Zero function

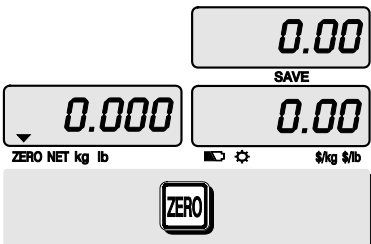



① Press **ZERO** key to set zero point.

d. Tare function

Tare means the weight of container. You may use tare function when you weigh an item with container and measure only the weight of item.

■ One time tare

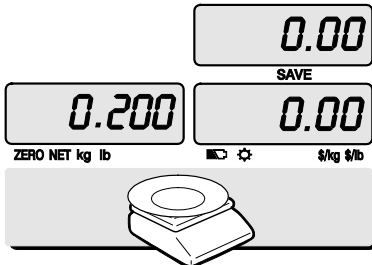

- ① Place a container on the platter.
Ex) 200g of tare.

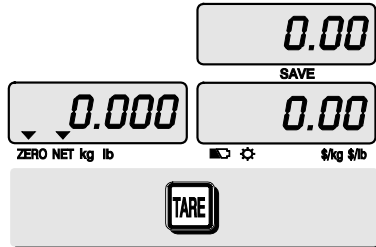

- ② Press **TARE** key to set zero point.
EX) 200g of tare.

■ Successive tare

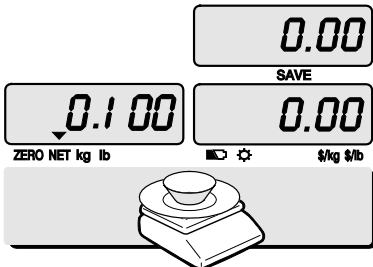

- ① Place another container on the platter.
Ex) 100g of tare

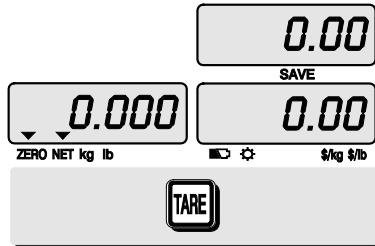

- ② Press **TARE** key to set zero point

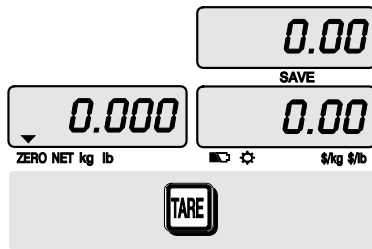
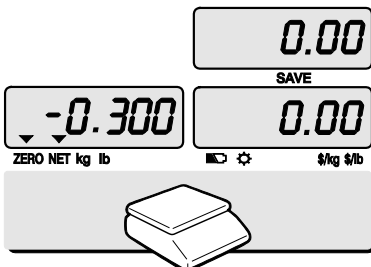



③ After weighing item remove all of the container from the platter.

④ Press **TARE** key again to set zero.

■ Preset tare

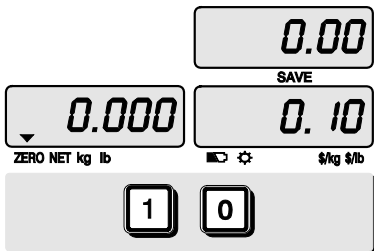

① Press appropriate numeric keys.
Ex) 10g

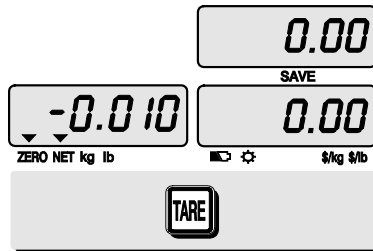

② Press TARE key to set tare.

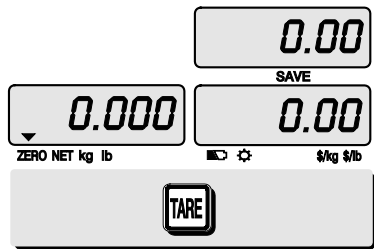

③ Press TARE key again to set zero.

Chapter 2. PLU Saving & PLU Calling-up

a. Saving unit price on PLU

This section explains how to save unit price in PLU.

	Number of PLU	Range	Remarks
PLU Name	200	1~200	

① Press numeric key to input unit price you wish to have. Ex) 1.99

② Press **MW** key.

③ Press numeric key to input a PLU address. Ex) PLU 10.

④ Press **MW** key to save it.

b. Saving tare weight on PLU

① Press numeric key to input tare weight you wish to have. And then press **MW** key to save it..

② Press **MW** key.

Ex) 0.100



c. Saving valid date set on PLU

This section explains how to save valid date in PLU.
You can input the valid date. Range is 0 ~ 999.

Valid date	Packed on date	Sell by date	Remarks
0	07.12.11 (Today)	(No print)	
1	07.12.11 (Today)	07.12.11(Today)	
2	07.12.11(Today)	07.12.12(Tomorrow)	
999	07.12.11(Today)	10.09.03(After 998 days)	

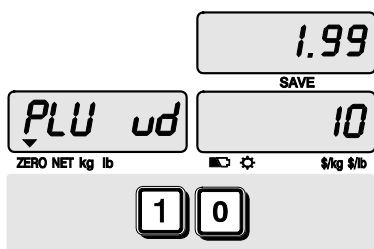

- ① Press numeric key to input a valid date
Ex) Sell by 9 days after

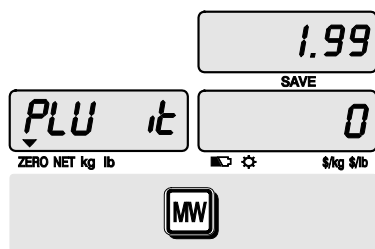

- ② Press **MW** key to save it.

d. Saving PLU item code

This section explains how to save valid date in PLU.

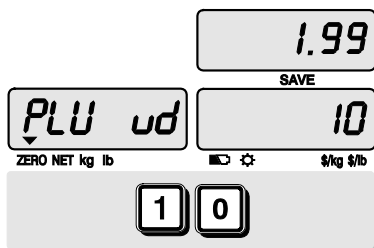

- ① Press numeric key to input a item code
Ex) Item code number "10"

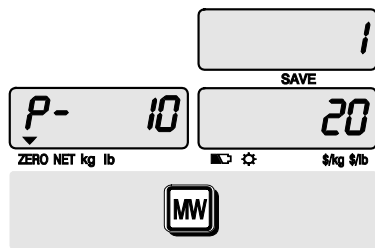

- ② Press **MW** key to save it.

e. Saving PLU name

- **C** key is to input, save a character, and move to next character (or byte).
- **TARE** key is to move next programming menu.

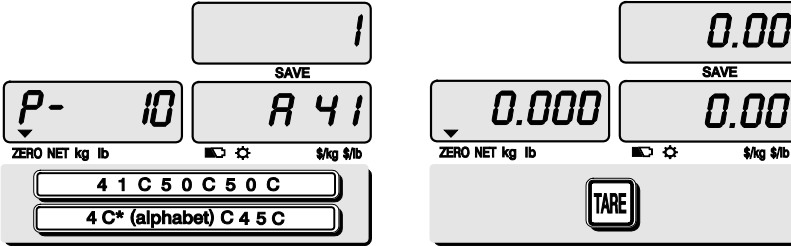

① Input appropriate ASCII codes to save the PLU name. ※ Please refer to the ASCII table on page 45.

Ex) "APPLE" is "4, 1, C, 5, 0, C, 5, 0, C, 4, C(alphabet), C, 4, 5, C"

② Press **TARE** key to exit to normal weighing mode or **C** key up to maximum 16th byte. Then automatically exit to normal weighing mode.

■ Please refer to "Alphabetic key location".

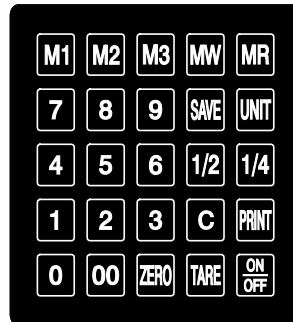
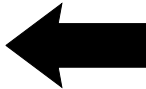
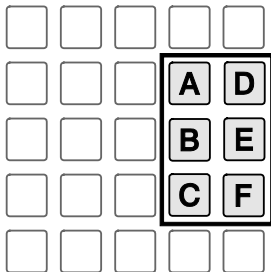

f. Calling up a PLU

■ Indirect PLU

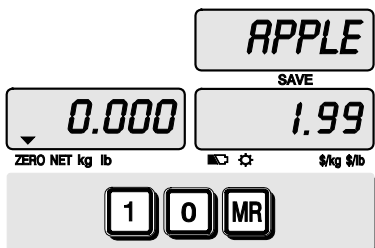

① To call up indirect PLU saved press appropriate numeric keys (address) and **MR** key
Ex) PLU 10

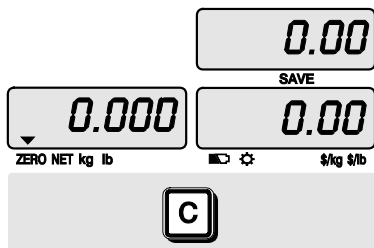

② To go back to normal weighing mode press **C** key

■ Direct PLU

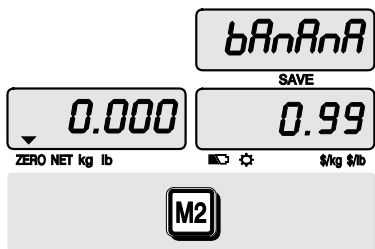

① To call up direct PLU saved just Press appropriate direct PLU key.
Ex) PLU 2

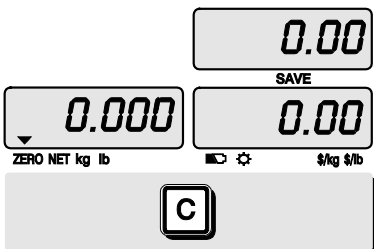

② To go back to normal weighing mode press **C** key

Chapter 3. User's Set-up Mode

This section explains how to set up the following functions.

Functions	Options	Remarks
1. Auto power-off	NO / 10 / 30 / 60	
2. LCD Backlight On/OFF	OFF / ON / 3 / 5 / 10	When backlight option selected in LCD version only
3. Backlight brightness	1 ~ 7	Default 3
4. Low battery backlight auto off	BL-on / BL-off	
5. Suspend Mode	0 / 20 / 40 / 60	Only LED version

① To get into "User's Set-up Mode" press **ON/OFF** key pressing and holding **ZERO** key.

6. Printer selection	NON / DEP-50 / DLP-50	
----------------------	-----------------------	--

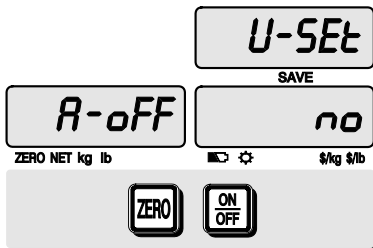

- Press **ZERO** key to save current option and move to next function setting mode.
- Press **TARE** key to move to other next option.

a. Auto power-off

This section explains how to set backlight on & off function and automatic off function.

Table :

Options	Description	Remarks
NO	No auto power-off.	
10 (minutes)	Auto power-off in 10 minutes when no use.	
30 (minutes)	Auto power-off in 30 minutes when no use.	
60 (minutes)	Auto power-off in 60 minutes when no use.	

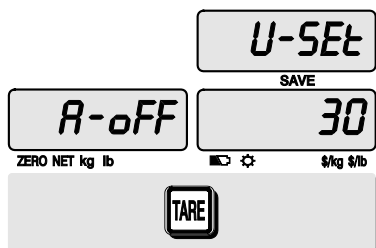

① Select an option you wish to have by using TARE key.
Ex) 30 (minutes)

b. LCD backlight ON/OFF function

(Option in LCD version only)

This section explains how to set backlight on & off function and automatic off function.

Table :

Options	Description	Remarks
OFF	Backlight always off	
ON	Backlight always on	
3 (Seconds)	Automatic backlight-off when not in use for 3 seconds.	
5 (Seconds)	Automatic backlight-off when not in use for 5 seconds.	
10 (Seconds)	Automatic backlight-off when not in use for 10 seconds.	

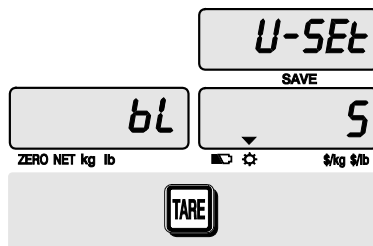
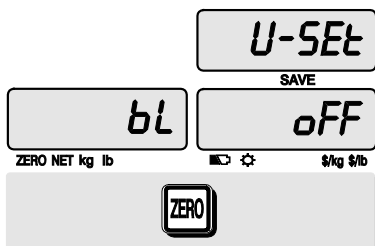

① Press **ZERO** key to move next function setting, backlight on/off

② Use **TARE** key to select one of backlight auto power-off option or backlight on/off
Ex) Select 5 seconds auto power-off option.

c. Brightness control

(Option in LCD version only)

This section explains how to set brightness level (1~7)

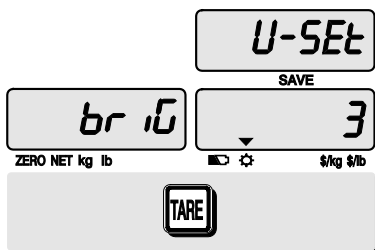

① Press **ZERO** key to move next function setting, backlight brightness.

② Press **TARE** key to select brightness. (1~7)

d. Low battery backlight auto off function

(Option in LCD version only)

This section explains how to set backlight auto off. If the scale uses backlight auto off function, it will turn off when low battery indicator occurs.

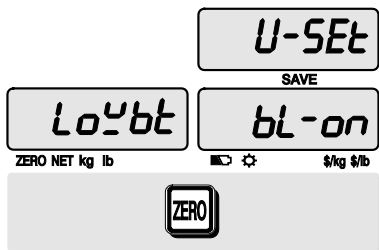

① Press **ZERO** key to move next function setting, low battery backlight auto off.

② Press **TARE** key to select backlight on/off.

※  : Low battery condition

e. Suspend mode function

(Only LED version)

This section explains how to set a time to suspend mode.

Table :

Options	Description	Remarks
OFF	No suspend mode.	
20(seconds)	Suspend mode in 20 seconds when no use.	
40(seconds)	Suspend mode in 40 seconds when no use.	
60(seconds)	Suspend mode in 60 seconds when no use.	Default

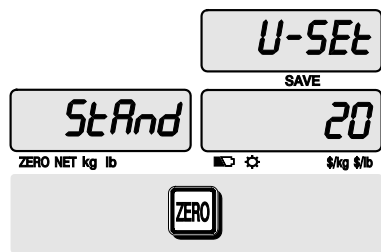

① Press **ZERO** key to move next function setting, suspend mode.

② Press **TARE** key to select a time to suspend mode.

f. Selecting the printer

This section explains how to select the printer option when you'd like to use the printer connected to ER^{PLUS}.

Table :

Options	Description	Remarks
NON	No printer in use	
DEP-50	DEP-50 printer interface	
DLP-50	DLP-50 printer interface	

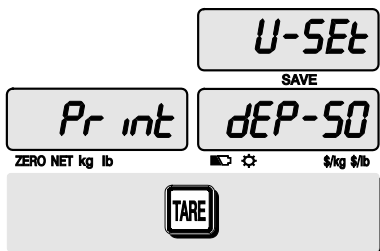

① Press **ZERO** key to move next function setting, selecting the printer

② Select the printer you're using with ER^{PLUS} by Pressing **TARE** key.
Ex) DEP-50

Chapter 4. Formatting printing receipt

This chapter explains how to set the receipt format in the following fields.

To set into "Printing format Setup mode" Press ON/OFF key pressing and holding C key.

Options	Description	Remarks
HEADER	To input characters you wish to have on the receipt header.	Maximum 1,2 line / 24 characters, 3 line / 16 characters for each line
UNIT (Currency)	To input currency symbol or characters you wish to have on the receipt.	Maximum 8 characters
DATE	To input date on the receipt.	

a. Setting the printer

Please connect your printer to RS-232 port, which is located at the gray part on the picture, using RS-232 cable.

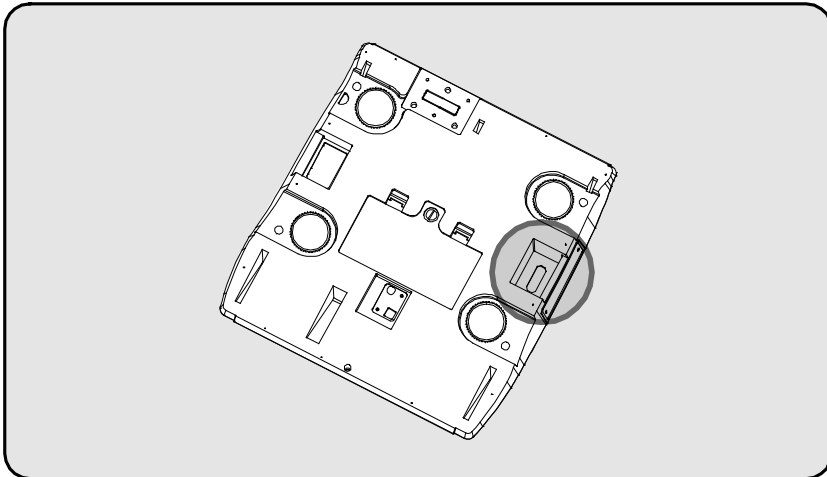



b. Receipt header setting

Options	Description	Remarks
HEADER	To input characters you wish to have on the receipt header.	Maximum 1,2 line / 24 characters, 3 line / 16 characters for each line

- User may input the name of store, telephone number, or other expressions he/she wishes to have on the receipt.

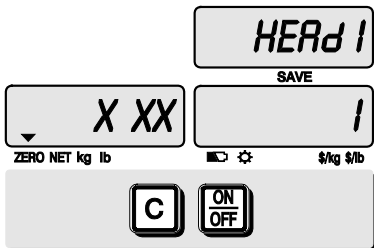

- ① Pressing and holding **C** key, press **ON/OFF** key under the scale power off. "1" on the "Unit Price" display represents that you are ready to input the first character.

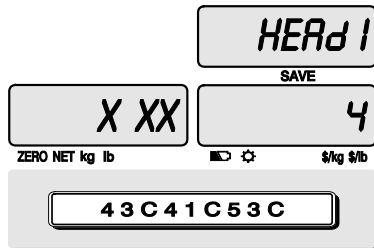

- ② Input appropriate ASCII codes (page on 45) you wish to have.
Ex) CAS.

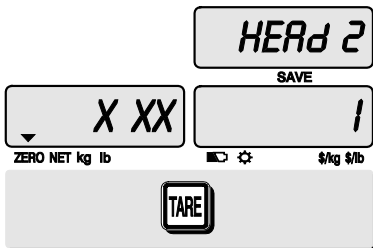

- ③ To save it and go next header line press **TARE** key.

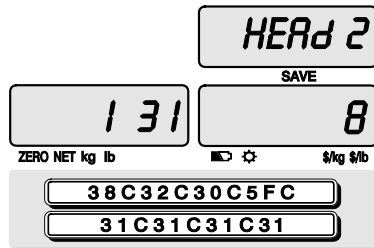

- ④ Using ASCII code you can input appropriate data on Header 2.
Ex) 820-1111, telephone #.

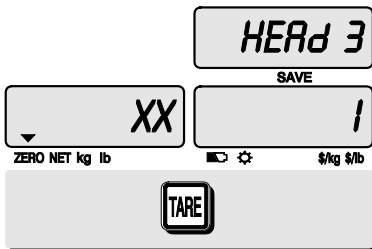

⑤ To save it and go next header line press **TARE** key.

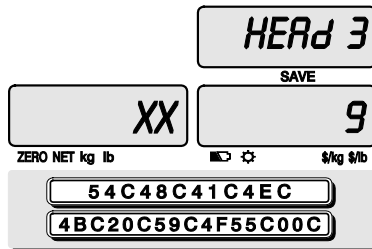

⑥ Using ASCII code you can input appropriate data on Header 2.
Ex) THANK YOU

c. Receipt currency (unit) setting

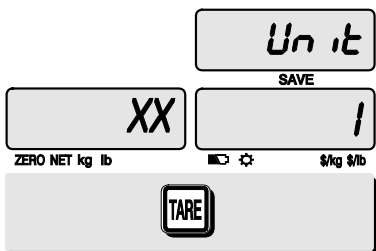

① Initial currency (unit) display status.

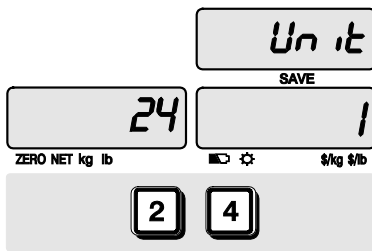

② Using ASCII code you can input appropriate character or currency symbols on unit.
Ex) \$

d. Receipt DATE setting

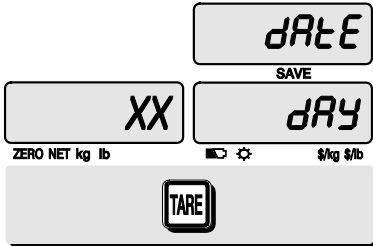

① To save it and go to "Initial DATE display" status press **TARE** key.

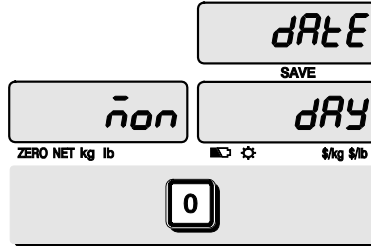

② Just input appropriate weekday you wish to have, using numeric key.
Ex) 0(Monday) ~ 6(Sunday)

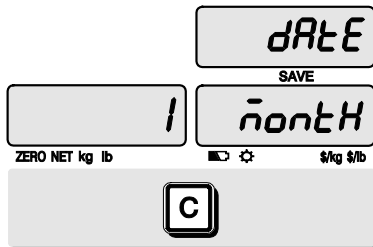

③ Press **C** key to go to next "Month" setting.

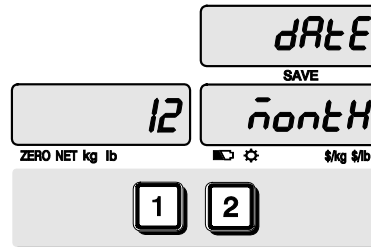

④ Just input appropriate month you wish to have, not using ASCII code.
Ex) 12 (December)

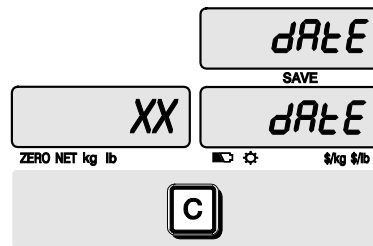

⑤ Press **C** key to go to next "Date" setting.

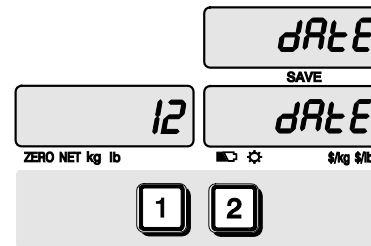

⑥ Just input appropriate date you wish to have, not using ASCII code.
Ex) 12th day

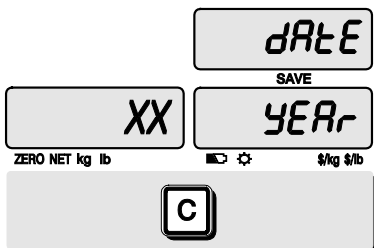

⑦ Press C key to go to next "Year" setting.

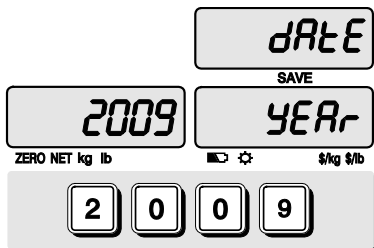

⑧ Just input appropriate year you wish to have, not using ASCII code.
Ex) Year 2009

e. Receipt TIME setting

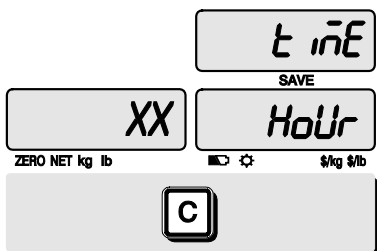

① Press C key to go to next "Hour" setting.

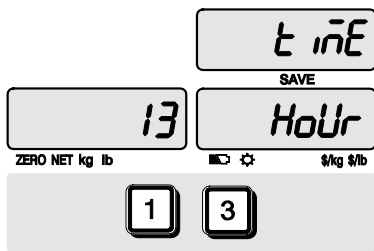

② Just input appropriate time you wish to have, not using ASCII code.
Ex) Hour 13 (PM 1:00)

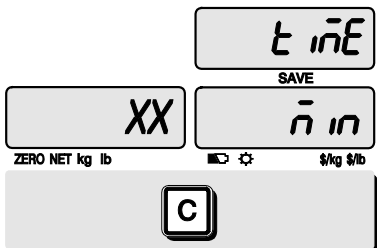

③ Press C key to go to next "Minute" setting.

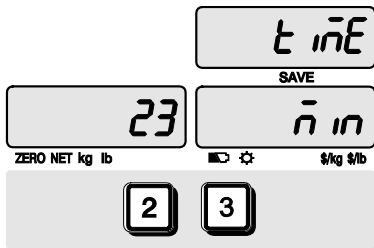

④ Just input appropriate minute you wish to have, not using ASCII code.
Ex) Minute 23



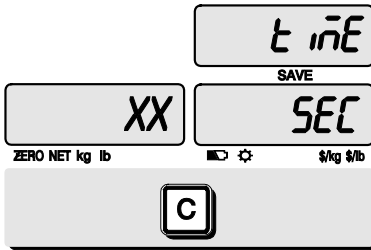

⑤ Press **C** key to go to next "Second" setting.

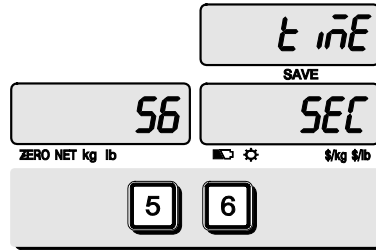

⑥ Just input appropriate second you wish to have, not using ASCII code.
Ex) Second 56

f. Receipt Date format setting

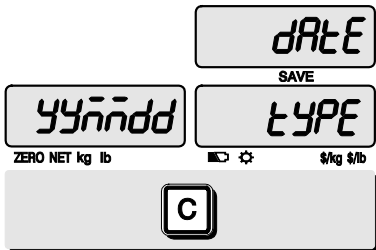

⑤ Press **C** key to go to next "Date format" setting.

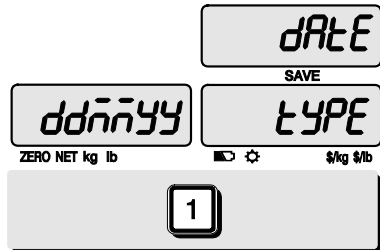

⑥ Just input a number according to below table.

Number	Date format
0	Year / Month / Date
1	Date / Month / Year

Ex) Press "1" to use DD/MM/YY print format

- If you press **C** or **T(TARE)** key you can automatically go to normal weighing mode.

g. Samples of Print format

■ DEP Printer

DATE. 2009/01/08/WED.		
TIME. 15:27:59		
=====		
weight	unit price	total
(kg)	(\$/kg)	(\$)
=====		
NO_PLU		
0.104	1234.56	128.39
=====		
Sum(\$)		128.39

II. Sales Mode

Chapter 5. Sales Transaction

- a. Sales with free price (hand pricing)
- b. Sales using PLU
 - direct PLU
 - indirect PLU

Chapter 6. Daily Total Sales

- a. Calling up daily total sales data
- b. Deleting daily total sales data

Chapter 5. Sales Transaction

ER^{PLUS} may make sales transaction either with free price or with PLU.

a. Sales with free price (hand pricing)

This section explains how to make sales transaction with free price (hand pricing).

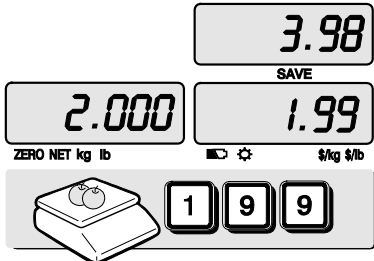

- ① Place an item on the platter and press appropriate numeric keys to input unit price.
Ex) 1.99 for unit price.

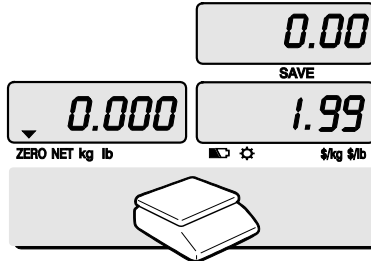

- ② Remove the item from the platter.

b. Sales using PLU (Price Look-Up)

■ Direct PLU

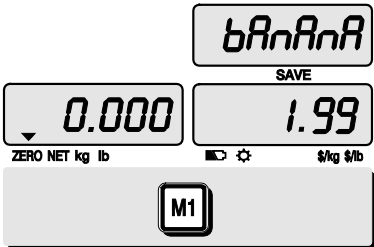

- ① Call up a direct PLU.
Ex) "M1"

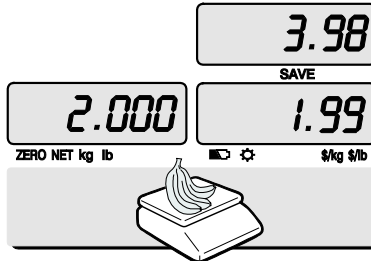

- ② Place an item on the platter.

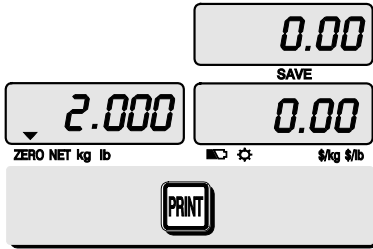

③ If you press **PRINT** key add this transaction to daily total amount and number of sales data, unit-price & total-price window is clear. ※ i connected printer, sale transaction data will printed out.

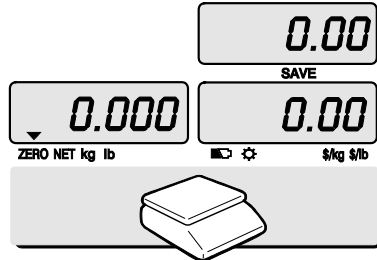

④ Remove the item from the platter.

■ Indirect PLU

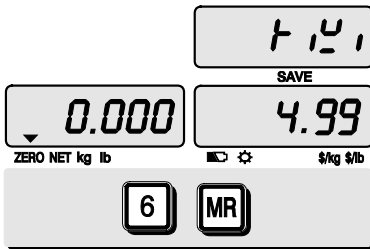

① Call up an indirect PLU.
Ex) "PLU 6 for Kiwi"

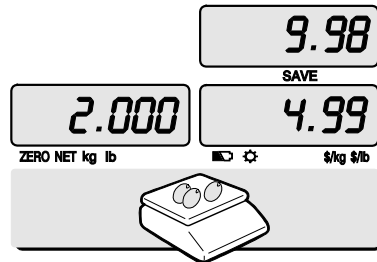

② Place an item on the platter.

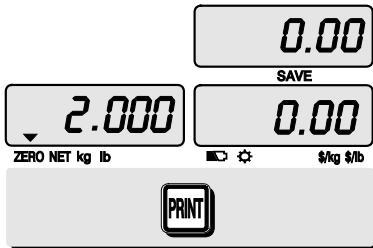

③ If you press **PRINT** key add this transaction to daily total amount and number of sales data, unit-price & total-price window is clear. ※ connected printer, sale transaction data will printed out.

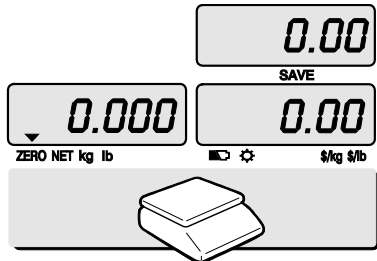

④ Remove the item from the platter.

Chapter 6. Daily Total Sales

a. Calling up daily total sales data

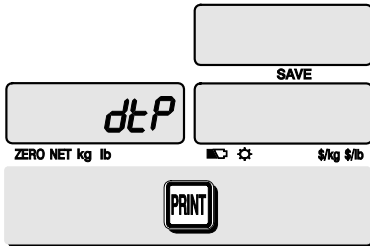

- ① Press Σ key for 3 seconds until "dtP" message shows up.

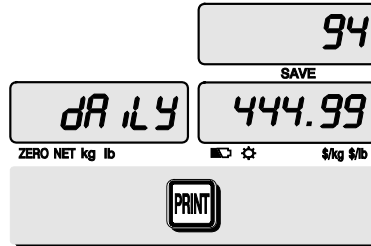

- ② Press Σ key again to call up daily total sales.
Ex) daily total amount of sales=444.99,

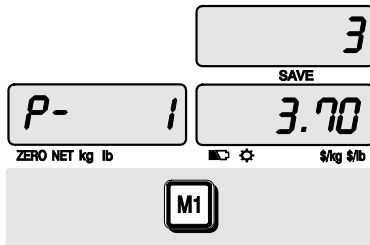

- ③ If you look at the amount of individual PLU sales call up appropriate PLU.
Ex) PLU#1(Banana: Direct PLU) & PLU # 14.

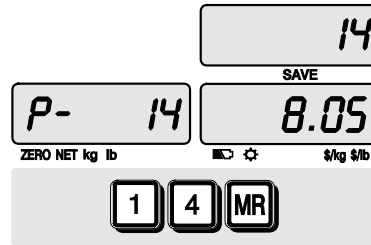

- ④ For PLU #14, press appropriate numeric keys and \square to show daily total amount of sales and the daily total number of sale transactions.

- To go back to "Daily total sales" mode simply press Σ key.

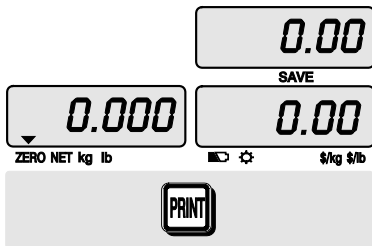

- ⑤ To go back to normal weighing mode, press Σ key.

b. Deleting daily total sales data

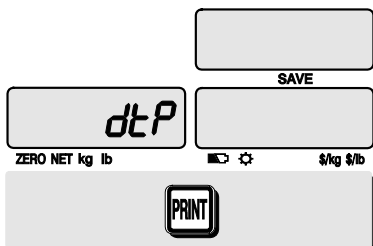

- ① Press Σ key for 3 seconds until "dtP" message shows up.

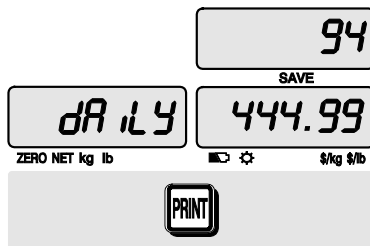

- ② Press Σ key again to call up daily total sales.
Ex) daily total amount of sales=444.99,

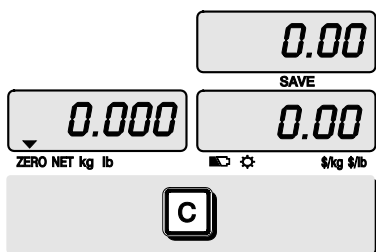

- ③ Press C key to delete "daily total sales" data. "Clear" message shows up shortly, and then it goes to normal weighing mode.

Table: ASCII Code

HIGH ORDER LOW ORDER	2	3	4	5	6	7	8	9
0	SP	0	@	P	'	p		
1	!	1	A	Q	a	q		
2	"	2	B	R	b	r		
3	#	3	C	S	c	s		
4	\$	4	D	T	d	t		
5	%	5	E	U	e	u		
6	&	6	F	V	f	v		
7	'	7	G	W	g	w		
8	(8	H	X	h	x		
9)	9	I	Y	i	y		
A	*	:	J	Z	j	z		
B	+	;	K	[k			
C	,	<	L	¥	l			
D	-	=	M]	m			
E	.	>	N	^	n			
F	/	?	O	_	o			

Picture1: Alphabet location on the keyboard

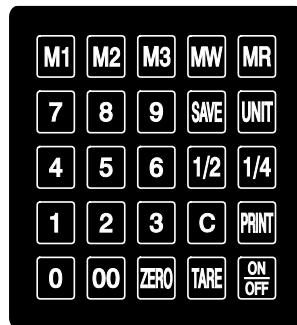
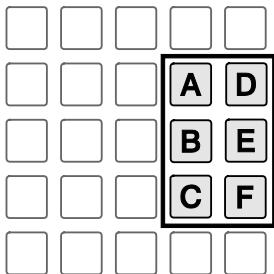

Table: Error Messages

Error Message on Display	Description	Solution
“Err 0”	The “Err 0” occurs when scale is not stable.	Remove unstable facts.
“Err 1”	The “Err 1” occurs when a current zero point has shifted from the last span calibration.	Please call your CAS dealer.
“Err 3”	The “Err 3” is an overload error.	Please remove the weight.
“Err 4”	The “Err 4” is short of payment.	Scale needs more payment.
“Err 5”	The “Err 5” means there is already tare.	Remove the tare.
“Err 6”	The “Err 6” means total price summation is over.	Please change unit price or remove some weight.
“Err 8”	The “Err 8” means Euro rating price is over.	Please change unit price or change euro rate.
“Err13”	The “Err13” means the soft key code is broken	Please try to find out which key lost soft key code and then input this code again.
“Err 15”	The “Err 15” means 1/2 or 1/4 unit price is over.	Please change unit price

Diagram : Serial Interface

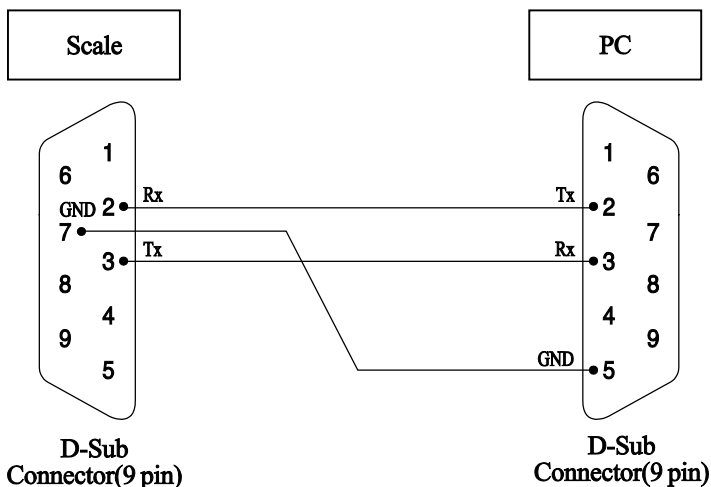



Table: SPECIFICATION

MODEL	S2000 Jr.		
CAPACITY	<u>Dual Interval</u> Max 3/6kg e = 1/2g	<u>Dual Interval</u> Max 6/15kg e = 2/5g	<u>Dual Interval</u> Max 15/30kg e = 5/10g
DISPLAY	S2000 Jr. : 5 / 6 / 6 (Weight/Unit Price/Total Price) S2000 Jr. - M : 6 / 6 / 8 (Weight/Unit Price/Total Price)		
SYMBOL ON DISPLAY	Power, Zero, Tare, Low battery, Backlight (Option for only LCD version)		
MAXIMUM TARE	- 2.999 kg	- 5.998 kg	- 14.995 kg
OPERATING TEMPERATURE	-10 °C ~ +40°C		
POWER SOURCE	12V DC Adaptor		
POWER CONSUMPTION	Approximately VFD Type 10W, LCD Type 5W, LED Type 7W(Charging)		
PLATTER SIZE (mm)	304 (W) x 220 (D)		
PRODUCT SIZE (mm)	Pole Type : 360 (W) x 350 (D) x 410 (H) Standard Type : 360 (W) x 350 (D) x 106 (H)		
PRODUCT WEIGHT	Pole Type : 5.5kg Standard Type : 4.7kg		
MINIMUM VOLTAGE LEVEL OF THE BATTERY	About 5.6V		
RECHARGEABLE BATTERY LIFE	When battery is charged for 12 hours		
	LCD VERSION Approximately 200 hours (backlight off)	LED VERSION Approximately 46 hours	VFD VERSION Approximately 6 hours
DRY BATTERY LIFE (ER PLUS-M)	LCD VERSION Approximately 150 hours (backlight off)	LED VERSION Approximately 30 hours	
BATTERY TYPE	S2000 Jr. : Pb battery, 6V 4Ah/20Hr S2000 Jr.-M : Pb battery, 6V 4Ah/20Hr / 1.5V C type dry battery * 6EA		
OPTIONS	Pole, Backlight(only LCD version),Battery(only VFD version)		



※ Notice : specifications are subject to change for improvement without notice.

MEMO

MEMO

MEMO

S2000 Jr. SERIES

Price Computing Scale