

OP-924 & 925 HANGING SCALES



FEATURES:

- Capacity: 500 to 100,000 lbs
- Die cast construction for harsh environments
- Up to 80 hours of battery life
- Rechargeable battery
- Wireless remote control
- Easy to read LED or LCD display
- Zero, Tare and Gross weighing features
- Selectable units: lbs, kgs
- Wireless indicator for W models
- One year limited warranty

OP-924 STANDARD HANGING SCALE



OP-925 HEAVY DUTY HANGING SCALE



SPECIFICATIONS				
	Product no.	Capacity	Weight	
STANDARD	OP-924A-500	500 x 0.1 lbs	12 lb	
	OP-924B-500			LED Red
	OP-924A-1,000	1,000 x 0.2 lbs		LCD Black
	OP-924B-1,000			LED Red
	OP-924A-1,500	1,500 x 0.5 lbs		LCD Black
	OP-924B-1,500			LED Red
	OP-924A-2,000	2,000 x 0.5 lbs		LCD Black
	OP-924B-2,000			LED Red
	OP-924A-3,000	3,000 x 0.5 lbs		LCD Black
	OP-924B-3,000			LED Red

OP-925 XL HEAVY DUTY HANGING SCALE 40K

Indicator is LED on one side and LCD on reverse side.



SPECIFICATIONS					
	Product no.	Capacity	Weight	Display	
HEAVY-DUTY	OP-925A-3,000	3,000 x 0.5 lbs	26 lb	LED Red	
	OP-925B-3,000			LCD Black	
	OP-925A-6,000	6,000 x 1 lbs		LED Red	
	OP-925B-6,000			LCD Black	
	OP-925A-10,000	10,000 x 2 lbs		30 lb	LED Red
	OP-925B-10,000			LCD Black	
	OP-925A-20,000	20,000 x 5 lbs		60 lb	LED Red
	OP-925B-20,000			LCD Black	
XL HD	OP-925A-40,000	40,000 x 10 lbs	190 lb	LED Red	
	OP-925B-40,000		LCD Black		

OP-925W WIRELESS CRANE SCALE

Comes with an LCD indicator in a protective carrying case.



SPECIFICATIONS				
	Product no.	Capacity	Weight	Display
WIRELESS	OP-925-W-10,000	10K x 2 lbs	110 lb	LCD BLACK
	OP-925-W-20,000	20K x 5 lbs	126 lb	
	OP-925-W-40,000	40K x 10 lbs	200 lb	
	OP-925-W-100,000	100K x 20 lbs	1,040 lb	

DIMENSIONS

OP-924 SCALE 500 LBS TO 3,000 LBS CAPACITY:

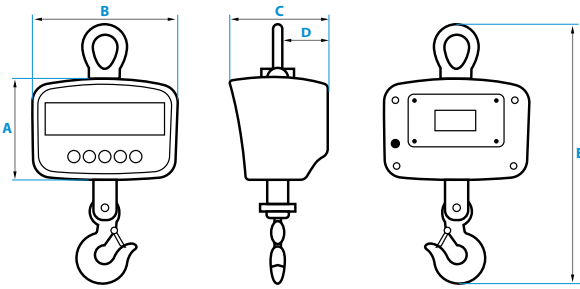

EXTERIOR DIMENSIONS	
A	5.88"
B	8.30"
C	5.45"
D	2.91"
E	15.16"-17.13"

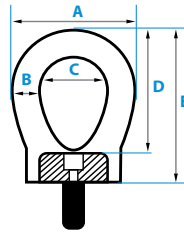

HOOK DIMENSIONS		UP TO 2,000 LBS.	
A	2.55"	F	0.90"
B	0.60"	G	0.90"
C	1.35"	H	2.92"
D	2.65"	I	0.96"
E	3.25"	J	3.15"
		K	4.92"

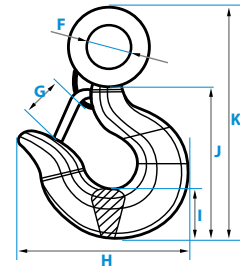

HOOK DIMENSIONS		OVER 2,000 LBS.	
A	2.55"	F	1.22"
B	0.60"	G	1.15"
C	1.35"	H	3.57"
D	2.65"	I	1.25"
E	3.25"	J	3.90"
		K	6.50"

OP-925 SCALE 3,000 LBS TO 40,000 LBS CAPACITY:

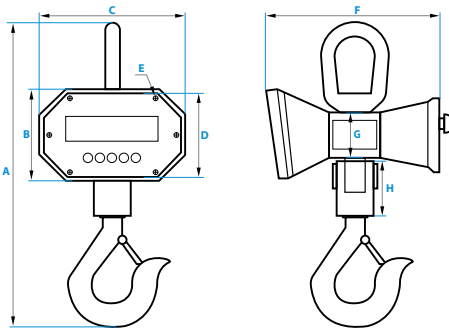

DIMENSIONS	
6K ; 10K ; 20K	
A	18.0" ; 26.0" ; 29.0"
B	6.14"
C	9.83"
D	5.65"
E	0.28"
F	11.21"
G	2.97"
H	3.54" ; 6.50" ; 8.50"

Under 10,000 lbs. ▼

10,000 lbs. And Up ▼

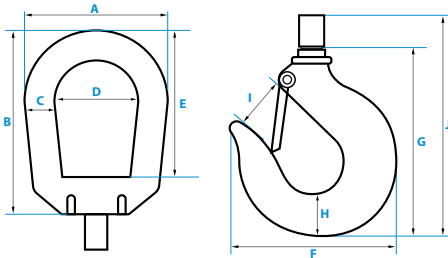

HOOK DIMENSIONS		UP TO 6,000 LBS.	
A	4.52"	F	4.54"
B	5.91"	G	5.36"
C	0.95"	H	1.45"
D	3.58"	I	1.45"
E	4.72"	J	6.06"

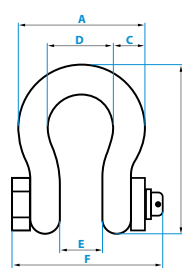

HOOK DIMENSIONS		10,000 LBS.	
A	5.40"	G	6.40"
B	7.00"	H	1.91"
C	1.25"	I	1.65"
D	2.95"	J	9.50"
E	1.92"	K	6.00"
F	6.50"		

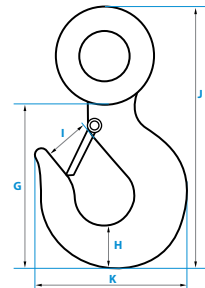

HOOK DIMENSIONS		20,000 LBS.	
A	6.00"	G	8.00"
B	8.00"	H	2.40"
C	1.40"	I	2.00"
D	3.21"	J	12.20"
E	2.21"	K	7.00"
F	7.25"		

OP-925W-WIRELESS

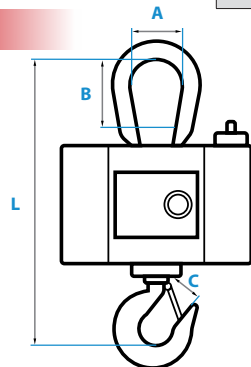

TC95 WIRELESS SCALE DIMENSIONS				
MAX CAP.	A	B	C	L
2,200 lbs	2.5"	4"	1.3"	4"
4,400 lbs	2.5"	4"	1.3"	4"
6,600 lbs	2.5"	4"	1.3"	4"
11,000 lbs	3"	4.5"	1.5"	4.5"