

900 SERIES INDICATOR USER'S MANUAL



TABLE OF CONTENTS

Safety Precautions.	1
Preparations and Set Up.	1
Features.	2
Specifications.	3
Power Supply.	4
Displays.	5
Display and Key Descriptions.	6
Operating Instructions.	7-9
Calibration.	10
Indicator Parameter Settings.	12-16
Helpful Definitions.	17
Connectors.	18-19
RS232 Serial Output Format.	20-23
4-20 mA Analog Output.	24
Relay Output.	25
Troubleshooting.	26
Q&A.	27
Contact Us.	28

SAFETY PRECAUTIONS

For safe operation of the weighing indicator, please follow these instructions:

- Calibration inspection and maintenance of the indicator are prohibited by non-professional staff
- Please ensure that the indicator rests on a stable surface
- The indicator is a piece of static sensitive equipment; Please cut off power during electrical connections
- Touching the internal components by hand is prohibited
- DO NOT exceed the rated load limit of the unit
- DO NOT step on the unit
- DO NOT jump on the scale
- DO NOT use this product if any of the components are cracked
- DO NOT use for purposes other than weight taking
- To avoid damaging the battery do not keep charger plugged in once battery is fully charged
- Make sure the weight is not over the Max capacity as it could damage the load cell inside
- Material that has a static electric charge could influence the weighing. Discharge the static electricity of the samples, if possible. Another solution to the problem is to wipe both sides of the pan and the top of the case with an anti-static agent

Please take anti-static prevention measures

Any accumulated charge on the body of the human operator should be discharged first before opening the protective container with ESDS devices inside. The discharge can be accomplished by:

- Putting a hand on a grounded surface or, ideally, by wearing a grounded Anti-static Wrist Strap and an Anti-static Mat

PREPARATION & SET UP

- Plug into a wall outlet to avoid interference with other wirings
- Turn on the balance while there is no load
- We suggest to warm-up the balance by powering on 5 minutes before use for accurate weighing
- Calibration may be required before weighing when the balance is initially installed or moved from a location

FEATURES

- LED or LCD display option
- Multiple weighing units: (kg/g/lb/oz/lb:oz)
- Gross/Tare/Pre-Set Tare/Zero
- Multiple Hold functions
- Count weighing
- Accumulation weighing
- Overload / Underload indication
- Connects to multiple printers
- Splash proof keyboard and display
- Connects to a Remote Display/Scoreboard
- Power saving mode
- Ability to modify gravity based on different geographical locations
- RS232 output
- NTEP approved for 5,000 divisions
- Relay output (optional) and 4-20mA analog output (optional)
- Can connect to a PC or printer for data logging (optional)
- Wireless capability (optional)
- Rechargeable battery (optional)

Indicator Model Options

900 series consists of the **900A (LED)** series and **900B (LCD)** series. Options for rechargeable battery, stainless steel enclosure, washdown enclosure, computer connection, relay output and analog output can be added.

Technical Parameters

- Accuracy class: 5000 e
- Resolution - Display: 30,000 ; ADC: 2,000,000
- Zero stability error: $TK0 < 0.1\mu V//K$
- Span stability error: $TKspn < \pm 6 \text{ ppm//K}$
- Sensitivity (internal): $0.3 \mu V / d$
- Input voltage: -30 to +30mV DC
- Excitation circuit: 5 VDC, 4 wire connection, 6 load cell of 350ohm max
- AC power: AC 100-250V (use only the included 9V adapter supplied)
- Operation temperature: $-10 \text{ }^\circ\text{C} \sim +40 \text{ }^\circ\text{C}$
- Operation humidity: $\leq 90\%RH$
- Storage temperature: $-40 \text{ }^\circ\text{C} \sim +70 \text{ }^\circ\text{C}$ (32-104°F)

SPECIFICATIONS

FIGURE 1: INDICATOR MEASUREMENTS

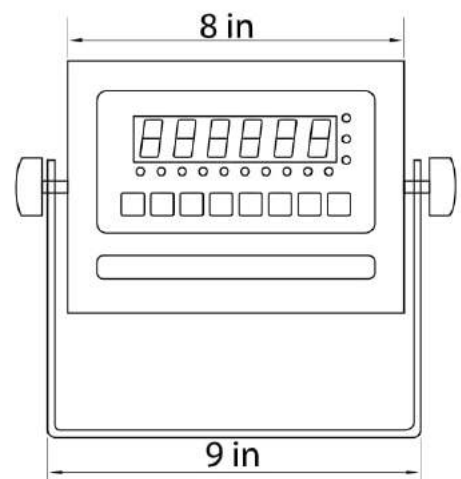
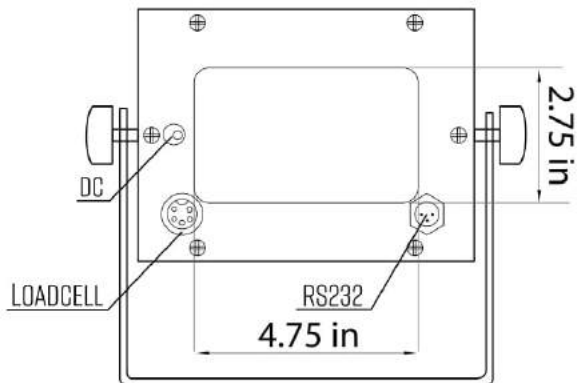
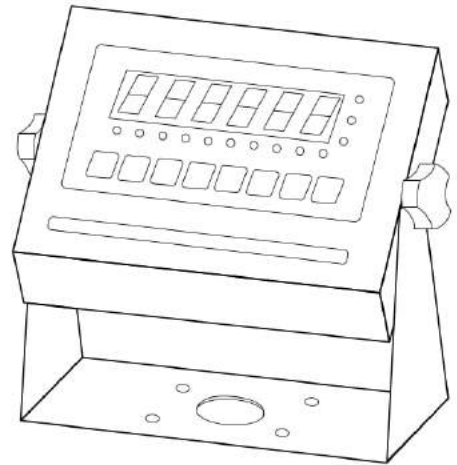
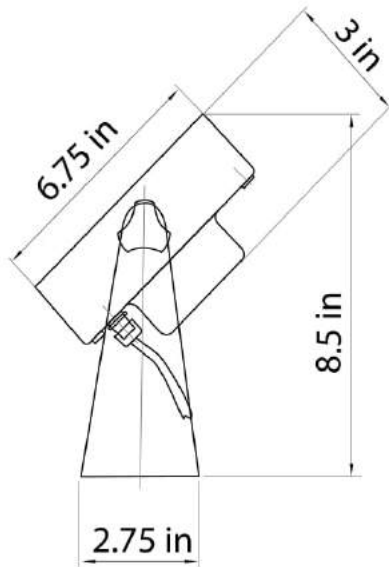

POWER SUPPLY

AC Adapter

If the indicator is powered by an adapter, plug the adapter directly into the "DC" pin located at the bottom of the indicator. We recommend to plug into a wall outlet to avoid interference with other wirings.



Battery (Optional)

If you have an indicator with the rechargeable battery option, please charge the internal battery fully before first time use. A 110 to 220V AC adapter should be provided with your indicator. Please use only the AC adapter provided to prevent damage to your indicator. To keep the battery in best condition, fully discharge the battery every month by leaving the indicator on until the indicator powers off, and then recharge fully. If the battery is not going to be used for a long period of time it is recommended to remove it to avoid leakage.

900A

- When the Battery is low the battery indicator light flashes red
- During charging the red light will stay lit
- The light will turn green once fully charged

900B

-  symbol will indicate battery's charge
-  symbol indicates that the battery needs to be charged



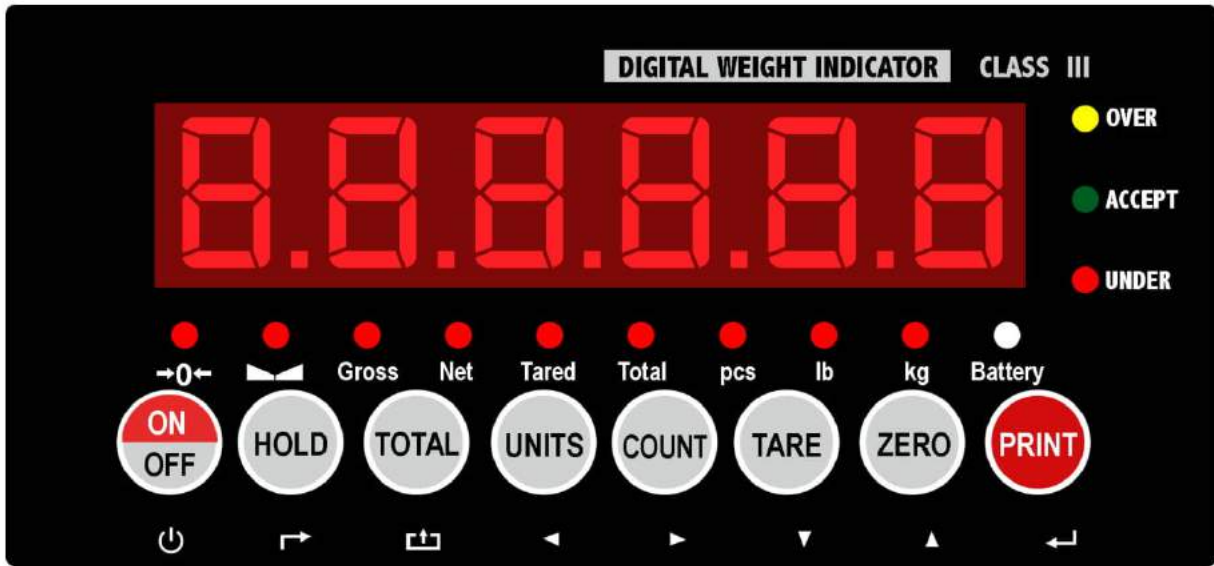

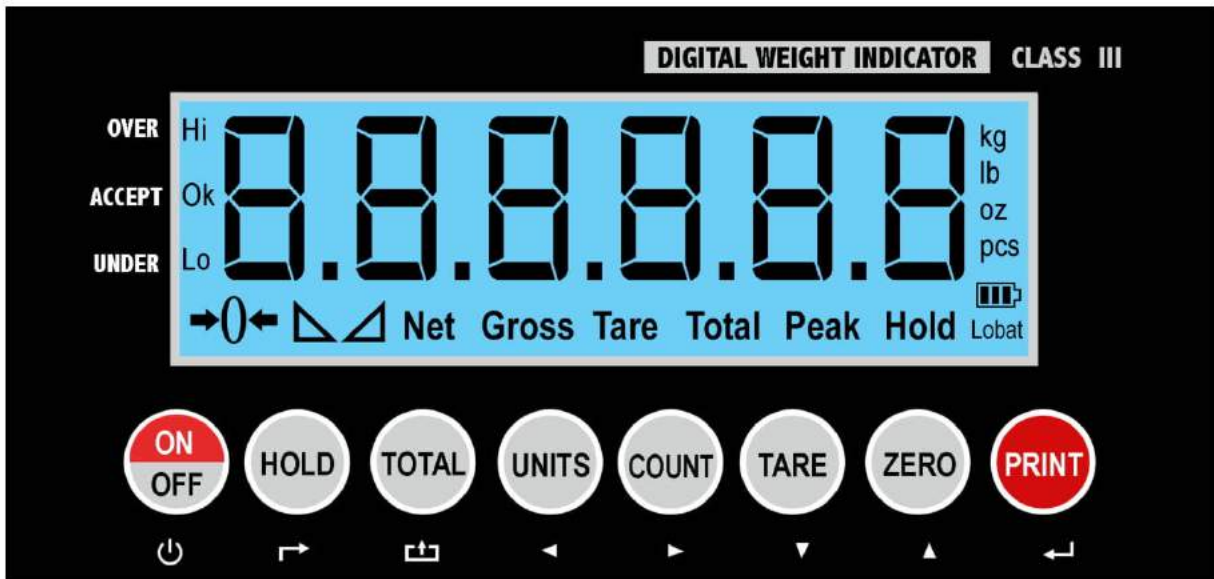

900A (LED)



900B (LCD)



DISPLAY AND KEY DESCRIPTION

ON/OFF	Powers the Indicator On or Off if held for 2 seconds
HOLD	1. Peak hold - Grabs the highest weight (for tension and pulling force) 2. Data hold - Holds the current weight value (ex. for use with weighing moving animals)
TOTAL	1. Accumulates weights 2. Works with "Print" to perform the accumulation function and check the accumulation result
UNITS	Shifts between weighing units
COUNT	Use the scale to count product based on a sample weight
TARE	1. Zero's the scale. Used when using a container to hold objects 2. Clears the tare to see the gross weight
ZERO	Zero's the scale
PRINT	Print data
	The scale is at zero
	The scale is stable
Gross	Shows you are in Gross weight mode (includes tare); default mode
Net	Shows you are in Net weight mode (weight without tared weight)
pcs	Shows you are in Counting mode
total	Shows you are in Accumulation mode
hold	Shows you are in Hold mode
lb	The weight is shown in pounds
kg	The weight is shown in kilograms
battery	Flashes red = low battery, Solid red = charging, Green = fully charged
Over	Flashes when weight is higher than set alarm parameter
Accept	Flashes when weight is within the set alarm parameters
Under	Flashes when weight is lower than set alarm parameter
	Power
	Back
	Save and Exit
	Arrow keys
	Return/Enter

OPERATING INSTRUCTIONS

Power On

- Turn on the power by pressing the power button for 2 seconds. Once on, the scale will flash the voltage and then begin to auto-check and count down from 0-9 sequentially before entering the weighing mode

Note: Anything on the scale before powering on will automatically be tared out.

Zeroing

- The zero function is used only when the scale is empty and is not at gross zero due to material build up
- Pressing the ZERO key will reset your scale to 0
- Depending on what your manual zero range parameter is set to, you can zero out any number within your set selection, after that you will receive an error and will need to tare out the weight

Unit Selection

- To switch between measuring units ((kg/g/lb/oz/lb:oz) press the UNITS key

Tare Function

- The Tare function is used when you only wish to see the current change in weight, not the entire amount of weight that is on the scale
- When the indicator is in gross mode (gross light is shown) pressing the TARE key will Tare the current weight on the scale and enter the net mode (net light shown)
- For example if you are using a container add the container to the scale, press tare and the display will show the tare symbol $\rightarrow 0 \leftarrow$ and reset back to 0
- Add your product to the scale to weigh without the weight of the container
- To exit Tare mode press the TARE key again to enter gross mode and you will see the total weight of the container and the product

Note: If you remove the container the scale will show the minus weight of the container

To use a pre-set tare weight

- Press and hold the TARE key for 2 seconds
- Input the tare weight using the arrow keys
- Press print key to confirm

Counting Function

- The counting function is used to count a high volume of identical parts. You can do this by setting a sample and then either adding to the sample or taking away from the sample to count the number of objects on the scale
- In weighing mode: Put a sample weight on the scale (Sample options are 5, 10, 20, 50, 100, 200, 500)
- Then press the COUNT key to go to the counting mode ("pcs" will light up)
- It will then display the sample number (ex. **PCS 0**) which you can change using the up or down arrows
- Press the PRINT key to confirm your sample number
- The scale is now ready to start counting, load your product on the scale and the indicator will show the quantity
- To exit counting mode press the COUNT key
- If you want to count a different product hold the PRINT and COUNT key together and the sample pieces will reset back to zero

Accumulation

- The accumulation function is used to add multiple weights and total them together
- In weighing mode load the first weight, once stable press the ACCUM key to enter the accumulation mode. The "total" light will display
- Remove weight and press ZERO key before adding the second weight to the scale
- Once stable press ACCUM key to add the weight to the accumulated total
- Press ZERO Key before adding the next weight to the scale
- Repeat previous step until all desired weights have been added to the total (max 999 times)
- When you are done and want to display the accumulated total, press the ACCUM and PRINT key together. The accumulated number "n###" (the number of weights you are adding together) will flash on the display followed by the total
- The total will display by flashing between 2 sets of numbers
- There are 8 digits in total, the display will flash 4 at a time, the first 4 on the left and the last 4 on the right. For example if the first 4 digits are "0012" and the last 4 digits are "3456" the actual weight is 001234.56 or 1234.56 lbs/kg
- If you want to print the accumulated total, hold the PRINT key for one second while the last 4 digits of the total are shown
- To exit accumulation mode, wait for the last 4 digits to the right of the screen to appear, and then press and hold the ACCUM key for one second
- "**[Lr n**" will be displayed, asking you if you want to keep the data?
 - If NO you do not want to clear the accumulated total, then keep "**[Lr n**".
 - If YES you do want to clear the accumulated total, then use the arrow key to change to "**[Lr Y**".
- Finally, press the PRINT key to select exit accumulation mode

Hold

There are five different hold functions, you can choose the best option for you and set it the parameter settings C11

- 1. Peak Hold:** Grabs the highest weight (for materials testing, ie. tension and pulling force)
 - Press the HOLD key then add weight to the scale
 - The indicator will show the highest weight it recorded and hold it on the screen until a higher weight is placed on the scale

- 2. Manual Hold:** Grabs the current weight and holds it so it will not change/fluctuate
 - While weighing, press HOLD and the indicator will hold the current weight on the screen until HOLD is pressed again

- 3. Auto Hold:** If the weight on the scale is above 20d and is stable, the indicator will hold that weight on the screen for 3 seconds then go back to general weighing
 - Pressing the hold key is unnecessary, holding is done automatically when the scale is stable

- 4. Average Hold:** Used for animal weighing, the indicator will display the average weight sampled from 1-9 seconds (Time set in parameter C39)
 - Add animal to scale and press HOLD
 - Indicator screen will show "L 0 0" for 1-9 seconds, then display the average weight from those seconds
 - Press HOLD again to exit holding mode































- 5. Auto Average Hold:** Used for animal weighing, the indicator will display the average weight sampled from 1-9 seconds without the need to press the HOLD key. If the weight on the scale is above 20d (scales division x 20) and is stable, the indicator will start grabbing the average weight sampled from 1-9 seconds (Time set in parameter C39). In parameter C40 you can set a determined loading time from 1-9 seconds. This is the time you have to load the animal before the scale begins to take the average weight.
 - Add animal to scale. Once weight is added to the scale, the scale will wait the set loading time and then the Indicator screen will show "L 0 0" for 1-9 seconds
 - It will then display the average weight from those 1-9 seconds for 3 seconds and then repeat the process

Print

- If the indicator is connected to a printer and the weight on the scale is stable press the PRINT key to print the current weight
- In accumulation mode hold the PRINT key for one second when the last 4 digits of the total weight are shown to print the total weight

Note: In tare mode the printer can not print if negative weight is shown

CALIBRATION PROCEDURE

1. Turn on the scale by holding ON/OFF  for 2 seconds.
2. Press HOLD  and PRINT  together to access the setup menu.
3. If done correctly, the display should now show **C0 1**.
4. Press PRINT  to access the C1 channel. The display should show [**C 1 #**].
5. Press ZERO  to choose which unit you want to calibrate in (1 = kg, 2 = lb).
6. Press PRINT  to set the value. The display will now show **C02**.
7. Press PRINT  to access the C2 channel. The display should show [**C2 #**].
8. Press ZERO  to change the setting to the decimal places desired (The C2 channel is used to adjust the decimal point on the scale. A value of 1 means there is one digit behind the decimal point.)
9. Press PRINT  to set the value. The display will now show **C03**.
10. Press PRINT  to access the C3 channel. The display should show [**C3 #**].
11. Press ZERO  to cycle through the values until the desired graduation appears. (The C3 channel adjusts the divisions on the scale. A value of 1 selected and C2 set to 1, the scale will read in 0.1 lb. increments.)
12. Press PRINT  to set the value. The display will now show **C04**.
13. Press PRINT  to access the C4 channel. The display will show [#####].
14. Enter in the maximum capacity you want to use for this scale by using UNIT  and COUNT  to move the cursor left and right, and TARE  and ZERO  to move the values down and up. (The C4 channel is used to enter in the max capacity of the scale; Make sure this doesn't exceed the max capacity of the scale; Max capacity divided by the increment set in C02 and C03 above cannot exceed 5000.)
15. Press PRINT  to set the value. The display will now show **C05**.
16. Press PRINT  to access the C5 channel. The display should show [**C5 0**].
17. The C5 channel calibrates zero on the scale. Make sure the scale is empty.
18. Press ZERO  to change the value to 1.
19. Press PRINT . The display will count down from 10-1 while the scale is calibrating zero. When the display shows 0 the zero calibration is complete.
20. Press PRINT  to continue. The display will now show **C06**.
21. Press PRINT  to access the C06 channel. The display will show [**C6 0**].
22. The C6 channel is used to calibrate the scale with a known weight. Press ZERO  to set the value of C6 to [**C6 #**]. Press PRINT . The display will flash **SPAN**, and then show [#####].
23. Enter the calibration weight value you will use (at least 10% of max capacity you set in C04 by using UNIT  and COUNT  to move the cursor left and right, and TARE  and ZERO  move the values down and up.
24. Place the calibration weight you have on the empty scale and press PRINT .
25. The scale will count down from 10 to 0. Once 0 has been reached, the display will show **CAL End**.
26. Press PRINT  to continue. The display will now show **C07**.

CALIBRATION cont.

27. Press ACCUM  to save and exit the setup menu.
28. The scale has now been calibrated. The display will show the value of the calibration weight on the scale.
29. If the scale does not show the value of the calibration weight, check that the feet on the platform are not screwed in too tightly, and verify that the platform is level.
30. Unload the scale; the display should read **000000**.
31. If the scale does not display 000000, check that the feet on the platform are not screwed in too tightly, and verify that the platform is level.

INDICATOR PARAMETER SETTINGS

The parameter settings menu has a calibration section (C01 to C07 explained above) and a parameter settings section (C08 and up).

To access the calibration section the seal switch (located at one corner of the PCB) must be OFF. This will allow access to all C01 and up settings. If the seal switch is ON, then only C08 and up can be accessed by the user. If you break the official seal by opening the back of the indicator to access the seal switch, you may need to have the indicator recertified. Be sure to adjust the seal switch back to the original setting after calibration/configuration has been performed.

To enter calibration/parameter settings, follow the procedure below:

1. Make sure the unit is set to either kg or lb
 2. Press and hold the HOLD and PRINT key at the same time for 2 seconds
 3. Navigate through the settings (C01 to C45) as shown in the table 4 below by using the arrow keys and return keys as labeled under each indicator button
 4. Press the PRINT  key to enter/edit the parameter setting
- Press the ACCUM key to save and exit settings at any time

Table 1. Indicator Parameter Settings

Function	Parameter	Settings/Options
Weighing Unit	C01	1 = kg 2 = lb 3 = gram 4 = oz Note: for calibration only kg or lb are allowed
Decimal Setting	C02	0 = no decimal 1 = #.# 2 = #.## 3 = #.### 4 = #.####
Graduation Setting (readability of the least significant digit)	C03	options: 1/2/4/10/20/50 Example with no decimal places (ie C02=0) 1 = 1 lb 2 = 2 lb 5 = 5 lb 10 = 10 lb 20 = 20 lb 50 = 50 lb
Maximum Capacity	C04	set max capacity ex. 100kg = 0100.00
Zero Calibration	C05	0 = zero calibration 1 = set the zero calibration (Please ensure scale is empty and the stable light is on)
Calibration	C06	0 = calibration not needed 1 = ready to calibrate with calibration weight
Restore Default Settings	C07	0 = do not restore 1 = restore to default settings

Function	Parameter	Settings/Options
Warning Tone	C 08	0 = turn off warning tone 1 = turn on warning tone
Automatic Power Off	C 09	0 = turn off auto power off 10 = power off automatically if no change within 10 minutes 30 = power off automatically if no change within 30 minutes 60 = power off automatically if no change within 60 minutes
Power Saving Mode	C 10	LED Version OP900A: 0 = turn off power saving setting 3 = turn off display if no change within 3 minutes 5 = turn off display if no change within 5 minutes LCD Version OP900B: 0 = turn off the backlight 1 = backlight only when the weight changes or keyboard is pressed 2 = constant backlight
Hold Function	C 11	0 = turn off hold function 1 = Peak hold - Grabs the highest weight 2 = Manual hold - Grabs the current weight 3 = Auto hold - Automatically holds data when stable 4 = Average hold - for animal weighing, averages the weight from a sample of 3 seconds 5 = Auto Average hold - Average hold without the need to press the hold key
Unit Conversion	C 12	* See table 2
Upper Limit Alarm	C 13	Set upper limit within the max. capacity
Lower Limit Alarm	C 14	Set lower limit within the max. capacity
Inner Code Display	C 15	check the inner code (raw data)
Set Date	C 16	Set date from left to right: year/month/day
Set Time	C 17	Set the time from left to right: hour/minute/second
Communication Setting	C 18	Set the serial interface data output method: 0 = Turn off serial interface data output 1 = Continuous sending mode, connect remote display 2 = Print mode, connect printer 3 = Command request mode, connect computer. 4 = PC continuous sending mode, connect computer 5 = PC/big display, continuous sending mode 6 = Print to adhesive label printer 7 = Print to Zebra adhesive label printer
Baud Rate	C 19	0=1200 (for remote display) 1=2400 2=4800 3=9600
Manual Zero Range	C 20	0 = turn off manually zero setting 1 = ±1% max capacity 2 = ±2% max capacity 4 = ±4% max capacity 10 = ±10% max capacity 20 = ±20% max capacity 100 = ±100% max capacity

Function	Parameter	Settings/Options
Initial Zero Range	C21	0 = no initial zero setting 1 = ±1% max capacity 2 = ±2% max capacity 5 = ±5% max capacity 10 = ±10% max capacity 20 = ±20% max capacity 100 = ±100% max capacity
Zero Tracking	C22	0= turn off zero tracking 0.5 = ±0.5d 1.0 = ±1.0d 2.0 = ±2.0d 3.0 = ±3.0d 4.0 = ±4.0d 5.0 = ±5.0d Note: the zero tracking range can not be bigger than manual zero range d = division
Zero Tracking Time	C23	0 = turn off zero tracking time 1 = 1 second 2 = 2 seconds 3 = 3 seconds
Overload Range	C24	00 = turn off overload range 01-99d = overload range setting d = division
Negative Display	C25	0 = -9d 10 = -10% max. capacity 20 = -20% max. capacity 50 = -50% max. capacity 100 = -100% max. capacity
Standstill Time	C26	0 = quick 1 = medium 2 = slow
Standstill Range	C27	1 = 1d 2 = 2d 5 = 5d 10 = 10d d = division
Digital Filter (for filtering moving weight such as animals)	C28	0 = turn off dynamic filter 1 = 1 digital filter strength 2 = 2 digital filter strength 3 = 3 digital filter strength 4 = 4 digital filter strength 5 = 5 digital filter strength 6 = 6 digital filter strength Note: The higher the number, the higher the filter strength
Noise Filter	C29	0 = turn off noise filter 1 = 1 digital filter strength 2 = 2 digital filter strength 3 = 3 digital filter strength
Print Time and Date	C30	0 = yy.mm.dd 1 = mm.dd.yy 2 = dd.mm.yy 3 = yy.mm.dd
Analog Output Setting	C31	0 = 0 - 5V output 1 = 4 - 20mA output

Function	Parameter	Settings/Options
Calibrate Current	C32	4 - 20mA current
Relay Output Setting	C33	0 = turn off relay output 1 = turn on relay output function 1 2 = turn on relay output function 2 3 = Reserved menu
Gravity of Calibration Location	C36	9.7000 - 9.9999
Gravity of Destination	C37	9.7000 - 9.9999
Version No.	C38	
Average Hold Sample Time	C39	1-9 Seconds = How many seconds sampled for the average weight
Loading Time	C40	1-9 Seconds = How long the scale waits (So you can load the animal on the scale) until it begins to take the average weight
Print Mode	C41	0 = auto mode 1 = gross mode 2 = tare mode
Print Carriage Return	C42	0 - 9 (How much space between print outs)
Space Print	C43	0 - 9 (Where the data prints on the paper: 0 = left ; 9 = right)
Date Print	C44	0 = do not print the date 1 = print the date
Time Print	C45	0 = do not print the time 1 = print the time

Table 2. Unit Conversion Parameter Settings

Parameter Settings	Units Available
C01= 3 & C12= 0	gram only
C01= 4 & C12= 0	oz only
C01= 1 & C12= 0	kg only
C01= 1 & C12= 1	kg/lb
C01= 1 & C12= 2	kg/lb/oz
C01= 1 & C12= 3	kg/lb/lb:oz/oz
C01= 1 & C12= 4	kg only
C01= 2 & C12= 0	lb only
C01= 2 & C12= 1	lb/kg
C01= 2 & C12= 2	kg/lb/oz
C01= 2 & C12= 3	kg/lb/lb:oz/oz
C01= 3 & C12= 4	lb only

Table 3. Default Parameter Settings

Function	Parameter	Default Setting
Weighing Unit	C01	1
Decimal Setting	C02	0
Graduation Setting	C03	1
Maximum Capacity	C04	1000
Zero Calibration	C05	0
Calibration	C06	0
Restore Default	C07	0
Warning Tone	C08	1
Automatic Power Off	C09	0
Power Saving Mode	C10	0
Hold Function	C11	0
Unit Conversion	C12	1
Upper Limit Alarm	C13	000000
Lower Limit Alarm	C14	000000
Inner Code Display	C15	
Set Date	C16	
Set Time	C17	
Communication Setting	C18	0
Baud Rate	C19	3 (9600)
Manual Zero Range	C20	10
Initial Zero Range	C21	10
Zero Tracking	C22	0.5
Zero Tracking Time	C23	1
Overload Range	C24	9
Negative Display	C25	10
Standstill Time	C26	1
Standstill Range	C27	2
Digital Filter	C28	0
Noise Filter	C29	2
Print Time and Date	C30	0
Analog Output Setting	C31	1
Calibrate Current	C32	4
Relay Output Setting	C33	1
Multi-connection add.	C34	0
Wireless Communication	C35	6
Gravity of Calibration Location	C36	9.7936
Gravity of Destination	C37	9.7936

HELPFUL DEFINITIONS

Division: The amount of increments a scale offers. How accurate the scale can be

Capacity: the maximum amount the scale can contain

Initial Zero Range: The percentage of weight allowed on the scale when indicator is powered on that will automatically zero.

example: If initial zero range is set to 10% of the max. capacity and your max. capacity is 100lbs, you can place up to 10lbs of weight on the scale and when the indicator is powered on, it will automatically zero out the weight.

Manual Zero Range: The percentage of weight allowed on the scale where the indicator will let you manually zero (anything above this percent will be tared)

Zero Tracking Range: A subset to the manual zero range; if the weight on the scale is not stable, the zero tracking range still allows you to zero within a set division of the scale

Zero Tracking Time: A subset to the zero tracking range, it is the time allowed for the scale to fall within the zero tracking range tolerance and still qualify to be zero'd

Overload Range: Weight allowance that is out of the set calibrated range. Adds a tolerance to the calibrated max. capacity without having to recalibrate.

example: If your scale has a max. capacity of 1000lbs with a division of 1 and you set the overload range to 60, you can add 1060lbs of weight to the scale without it displaying an error code

Negative Display: How far you can go in the negative direction before displaying an error code

Standstill Time: How fast the scale will stabilize

Standstill Range: How much the scale can fluctuate before being determined stable

Digital Filter: For filtering moving weight, such as animals, It changes how sensitive the scale is to variations in movement.

Noise Filter: A filter for how susceptible the scale is to general variations

Baud Rate: The rate at which information is transferred in a communication channel.

example: In the serial port context, "9600 baud" means that the serial port is capable of transferring a maximum of 9600 bits per second.

CONNECTORS

Connecting load cells to the indicator

- The indicator can connect with 6 load cells of 350Ω at most
- 4 wire or 6 wire load cell connections are both okay
- Please contact us directly if you have other special needs for your application
- There are two connection methods between the load cell and indicator

Quick Disconnect as shown below:

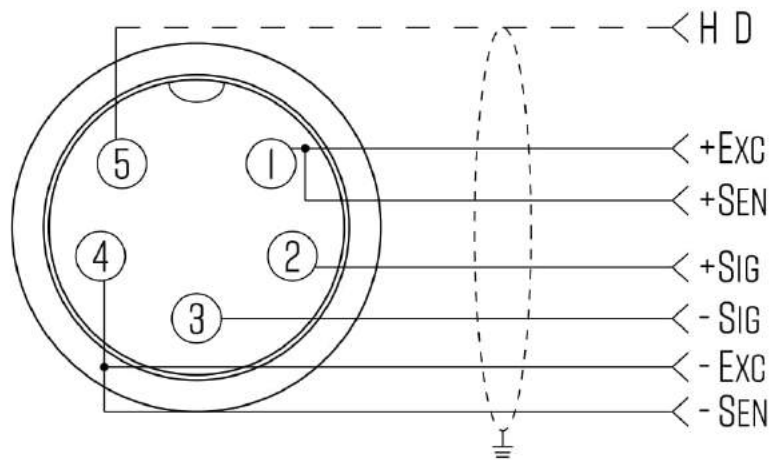

FIGURE 2: QUICK DISCONNECT CONNECTION DIAGRAM

Hardwire (Using Inner Terminal Block Connection:

Note: Make sure you follow all the anti-static rules to avoid damage to your indicator

- Excitation voltage: 5V DC
- Largest output current: 120 mA
- Excitation circuit: 5 VDC, 4 wire connection, 6 load cell of 350ohm maximum
- Open the back cover of the weighing indicator, and insert signal cable to the terminal block (see figure 3); Make sure the screw on terminal block is fixed tightly

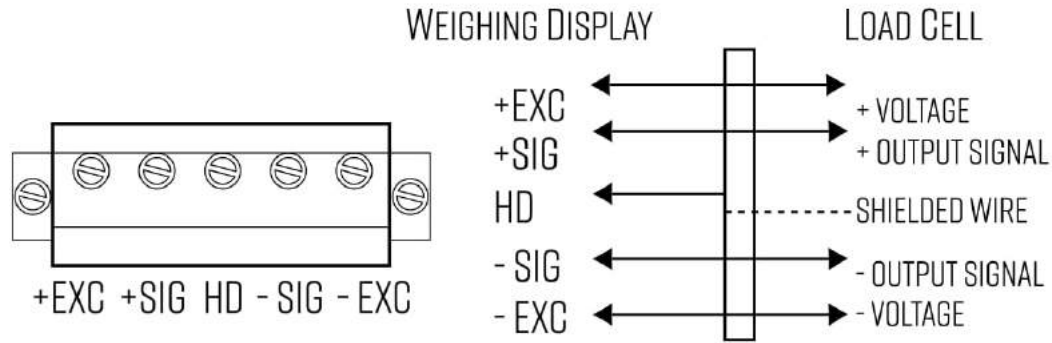

FIGURE 3: INNER TERMINAL BLOCK CONNECTION DIAGRAM

Table 4. Wiring Color Code

Signal Name	Color Code	Description
+Exe/ +EX	RED	Positive excitation voltage to load cell
+IN / +SIG	GREEN	Positive output signal from load cell
HD / SHLD	YELLOW/THICK BLACK	Shield Wire
-IN / -SIG	WHITE	Negative output signal from load cell
-EXC / -EX	BLACK	Negative excitation voltage to load cell

DB9 Connection (9 pin Serial Connector)

The DB9 9 pin serial connector is used for different purposes depending on the indicator model

- Figure 4 shows the pin assignment on the DB9 9 pin connector

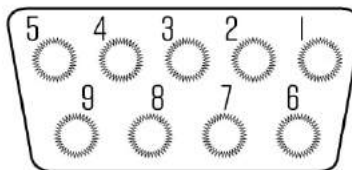

FIGURE 4: DB9 SERIAL CONNECTOR PINOUT

There are 3 Output formats to choose from

1. RS232 Serial Output Format (Standard)
2. 4-20 mA Analog Output (Optional)
3. Relay Output (Optional)

RS232 SERIAL OUTPUT FORMAT

Follow the pin out of Table 5 below to connect the indicator the RS-232 Serial device

Table 5. DB9 Pin Description

DB9 Pin	Definition	Function
2	TXT	Transmit Data
3	RXD	Receive Data
5	GND	Ground Interface

The serial output format depends on the settings for parameter C18. The serial output consists of a string of ASCII characters. Here is a list of the serial parameters

- 8 data bits
- 1 stop bits
- No parity
- No handshaking

Note: With the RS232 Output option we have data logging software available as seen in Figure 5.



FIGURE 5. DATA LOGGING SOFTWARE

Below are the formats of the serial output

- C18=0 - Turn off serial interface data output
- C18=1 - Continuous sending mode, connect 2nd big display
- C18=2 - Print mode, connect printer
- C18=3 - Command request mode, connect computer.
- C18=4 - PC continuous sending mode, connect computer
- C18=5 - PC/big display, continuous sending mode
- C18=6 - Print to adhesive label printer
- C18=7 - Print to Zebra adhesive label printer

Remote Display Continuous Sending Mode (C18=1)

For use with a Scoreboard/Remote Display

Note: Baud Rate must be set to 1200 (C19 = 0)

Output Continuous Format																	
S	S	S	S	X	X	X	X	X	X	X	X	X	X	X	X	C	C
T	W	W	W												R	K	
X	A	B	C												S	S	
1	2		3				4				5	6					

State A					
Bits0,1,2					
0	1		2		Decimal point position
1	0		0		XXXXXX0
0	1		0		XXXXXXX
1	1		0		XXXXX.X
0	0		1		XXXX.XX
1	0		1		XXX.XXX
Bits3,4					Division
0		1			X1
1		0			X2

State B	
Bits5	function
Bits0	gross=0, net=1
Bits1	Symbol: positive=0, negative=1
Bits2	Overload (or under zero)=1
Bits3	dynamic=1
Bits4	unit: lb=0, kg=1
Bits5	Constant 1
Bits6	Constant 0

State C			
Bit2	Bit1	Bit0	unit
0	0	0	Kg or lb
0	0	1	g
0	1	0	t
Bit 3			printing=1
Bit 4			Extend display=1
Bit 5			Constant 1
Bit 6			Constant 0

Print Mode (C18 = 2)

For printing on a non-adhesive ticket printer. Parameters 16, 17, 30, & 42-45 all effect your ticket print out.

Normal weighing ticket printout example:

Date:	05/01/2017
Time:	11:30:52
Net:	25.6lb
Tare:	10.3lb
Gross:	35.9lb

Accumulation weighing ticket printout example:

Date:	05/01/2017
Time:	11:30:52
n001	15.4lb
n002	17.2lb
n003	35.6lb
Total	68.2lb

Command Request Mode (C18=3)

In this mode, the indicator can receive ASCII commands as listed below

Command	Name	Function
T	Tare	Save and clear tare
Z	Zero	Zero gross weight
P	Print	Print the weight
R	G.W/N.W	Read gross weight or net weight
C	Kg/lb	Kg/lb conversion
G	G.W	Check gross weight at net weight mode

The R command will trigger the indicator to output the following data format:

<STX>	<POL>	XXXXX.XX	<SP>	<LB/KG>	<SP>	<GR/NT>	<CR>	<LF>
Start Transmission	Polarity: <SP> = Positive "- " = Negative	Weight Data	Space	Units: lb = punt kg = kilogram pcs = pieces*	Space	Gross/Net: GR = Gross NT = Net	Carriage Return	Line Feed

Computer Continuous Sending Mode (C18=4)

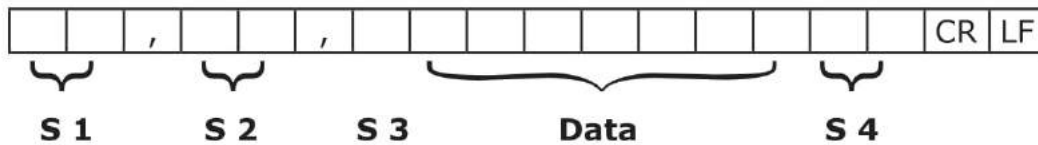

- S1: weight status, ST=standstill, US=not standstill, OL=overload
- S2: weight mode, GS=gross mode, NT=net mode
- S3: weight of positive and negative, "+" or "-"
- Data: weight value, including decimal point
- S4: "kg" or "lb"
- CR: carriage return
- LF: line feed

PC or Remote Display Continuous Sending Mode (C18=5)

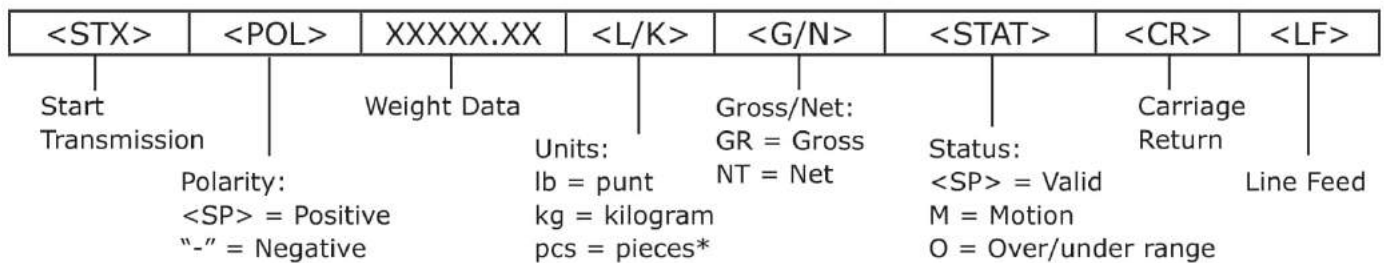

Print to Adhesive Label Printers (C18=5) & (C18=6)

The following are the printing formats:

Date:	05/01/2017
Time:	11:30:52
Net:	25.6lb
Tare:	10.3lb
Gross:	35.9lb

Optima Label Printer

Date:	XX.XX. XX (yy.mm.dd)
Time:	XX.XX.XX (hh.mm.ss)
NET	6.00kg (net weight)
TARE	2.88kg (tare)
GROSS	8.88kg (gross weight)

Zebra Label Printer

4-20 mA ANALOG OUTPUT (OPTIONAL)

The 4-20 mA analog output of the OP-900 scale is a voltage sourcing sensor that will output current which is proportional to the calibrated scale's weight range (i.e. 4 mA = 0 LBS and 20 mA = 10,000 LBS). It is important to note, that this is a sourcing output sensor (i.e. the sensor will source 9VDC with an output current range of 4-20 mA). Unlike many other "loop powered" type 4-20 mA sensors, an external supply voltage should not be connected to the unit's 4-20 mA circuit, however, the ground connection (pin 6) of the DB-9 connector will need to be connected to the same ground as the data acquisition device which will be responsible for interoperating the 4-20 mA signal. This ground connection is imperative, as both the data acquisition device's power supply and the scale's internal 9VDC power supply will need to be on the same ground plane for the output current to be synced and measured correctly. Please reference Figure 6 as a visual clarification on how to connect your scales 4-20 mA output to a data acquisition device.

FIGURE 6. CONNECTION DIAGRAM

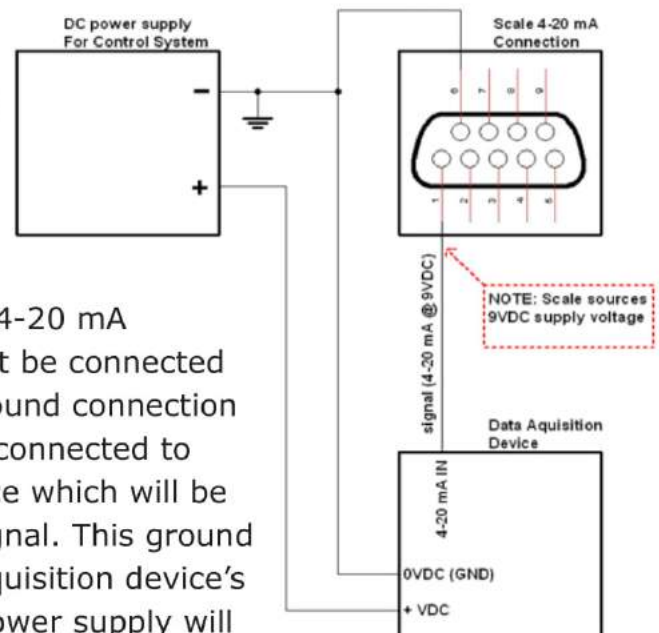

Below is a list of important notes when using the indicator with the 4-20 mA option

- Resolution: 1/1000
- Outside Load: 100-350ohms
- Inside connection: load input port pin "1" of J2, ground port pin "GND" of J2
- Outside connection: load input port pin 1 of DB9, ground port pin 6 of DB9
- To test the connection, connect a 250 ohm load; Locate a volt meter, and probe across the 250 ohm load. As the weight input to the indicator varies, the voltage of the volt meter will change accordingly
- Pressing the TARE key will reset to output current to 4mA
- 0-20mA output can be set by setting parameter C31 to 0
- Please note that this option will disable the RS232 weigh data output (serial ASCII data) that comes in the standard indicator

Calibration:

- Press PRINT and HOLD key to go into configuration mode
- Go to C32 and press PRINT key
- The display should show [out-4] and output should be at 4mA
- Press the up/down arrow keys and the [out-#] will increase/decrease

Note: X corresponds to the output current. For example if out-12 is displayed, then 12mA should be the output. If not, press the left and right arrow key to adjust/calibrate

RELAY OUTPUT (OPTIONAL)

- The indicator can output 4 signals, which when connected to outside equipment, can perform an automatic control function and an upper/lower limit alarm function.
- Change parameter setting C33 following Table 6 below:

Table 6: Relay Output Parameter Setting

	Output Port	Port Definition	Function
C33=0	Out1	Turn off output function	No Output Signal
	Out2	Turn off output function	No Output Signal
	Out3	Turn off output function	No Output Signal
	Out4	Turn off output function	No Output Signal
C33=1	Out1	Turn on overload control function	Output overload control signal
	Out2	Turn on compliance control function	Output compliance control signal
	Out3	Turn on under-load control function	Output under-load control signal
	Out4	Turn on stable control function	Output stable control signal
C33=2,3	Preserved, no function		

Table 7 below shows the DB9 port pinout for the relay output option. Please note that this is optional and only available for the OP-900 indicator ordered with this option.

The relay output option will disable the RS232 weigh data output (serial ASCII data) that comes in the standard indicator.

Table 7: Relay Output Pin Definition

DP9 Pin	Definition	Port
1	1 st output signal pin	Out1
6	1 st output signal pin	Out1
2	2 nd output signal pin	Out2
7	2 nd output signal pin	Out2
3	3 rd output signal pin	Out3
8	3 rd output signal pin	Out3
4	4 th output signal pin	Out4
9	4 th output signal pin	Out4

Rating:

AC 250V 3A

DC 30V 3A

TROUBLESHOOTING

Error Codes

Error	Reason	Solution
UUUUUUU	<ol style="list-style-type: none"> 1. Overload 2. Wrong connection with load cell 3. Load cell has quality problem 	<ol style="list-style-type: none"> 1. Reduce the weight 2. Check load cell connection 3. Inspect load cell; Check the input/output 4. See Q&A section
nnnnnnnn	<ol style="list-style-type: none"> 1. Calibration is no good 2. Wrong connection with load cell 3. Load cell has quality problem 	<ol style="list-style-type: none"> 1. Make sure scale is level 2. Check load cell connection 3. Check load cell input and output resistance 4. See Q&A section
Err 1	During calibration, weight is not used or the weight is above the max. capacity	Use correct weight within the defined range
Err2	During calibration, the weight is below the minimum required weight	The calibration weight minimum is 10% of the max. capacity set in C04. Recommended to use 60%-80% of max. capacity if possible
Err3	During calibration, the input signal is negative	<ol style="list-style-type: none"> 1. Check all wire connections 2. Check load cell 3. Recalibrate 4. PCB replacement needed if steps 1-3 fail
Err4	During calibration signal is unstable	After the platform is stable, start calibration
Err5	EEPROM Error	Change PCB
Err6	Exceed Zero Range	See Q&A section

Q&A

Q: The scale does not turn on

A: Make sure the power cord is plugged in, and that there is power. One easy way to test this is by connecting another appliance to the same outlet and see if it's operational

Q: The reading goes negative when a load is applied

A: Try interchanging the Sig+ and Sig- wiring connected to the load cell and/or junction box (if one is used)

Q: How do I resolve ERR6 error?

A: Please follow the procedure below:

- 1) Turn on the indicator and make sure nothing is on the scale, and that the scale is level and not wobbling
- 2) Press and hold the "PRINT and HOLD" key simultaneously for a few of seconds
- 3) The screen will read "C01"
- 4) Using the arrow keys, change C01 to C20. You have to change the 1st digit from 0 to 2 first before you can change the 2nd digit 1 to a 0.
- 5) Press "PRINT" key to enter C20 parameter
- 6) Change the value of C20 on the right to 100 if possible using the up arrow key. If 100 is not available change to 20
- 7) Press "PRINT" key to enter your selection
- 8) The screen will read "C21" now
- 9) Press "PRINT" key to enter C21 parameter
- 10) Change the value on the right of C21 to 100 if available, 20 if not
- 11) Press "PRINT" key to enter your selection
- 12) The screen will read "C22" now
- 13) Press "TOTAL" key to save and exit
- 14) Power the indicator off and then on, and see if this resolves the ERR 6 issue. If not, then following the Q&A answers below for resolving "nnnnnn" and "uuuuuu" errors

Q: How do I resolve "nnnnnn" and "uuuuuu" error?

- A:
- 1) Check to see if the cable that runs from the indicator to the junction box is damaged. If it is, replace the cable.
 - 2) Open up the junction box (if available) and check to see if there is any water damage. If so, replace the junction box
 - 3) Make sure all the wires on all 5 terminal blocks (5 wires on each terminal block) are not loose. Re-tighten the screws even if the wires seem to be connected
 - 4) Recalibrate
 - 5) If steps 1-4 do not work, there is a possibility one or more load cells are defective (consult with support@optimascale.com for further instructions)