

67XXU

USB/Serial Scale Series



Service Manual

SOFTWARE VERSION 1.20

AWT35-501145
Issue AG

Table of Contents

Chapter 1 General Information and Warnings	5
About this Manual	5
Text Conventions	5
Special Messages	5
Warnings	6
Routine Maintenance	6
Sharp Objects	6
Cleaning the Indicator	6
CE Certification	7
Chapter 2 Installation	8
Connections	9
Display	9
Power Supply	9
USB Port (Com 1)	9
RS-232 Serial Port (Com 2)	9
Column and Remote Display Mounting	10
Mounting the Display to the Scale Base	14
Desktop and Wall Display Mounting	17
Mainboard	18
Definition of Connectors and Jumpers	18
Chapter 3 Specifications	20
Available Models	20
Outline Dimensions	20
Mounting	21
Power Supply	21
Display	21
Keypad	21
Environment	21
Load Cell Excitation	21
Approvals	21
Communication	22
Analog Circuitry	22
Capacity and Division	22
Accuracy	22
Calibration Method	22
Other Main Functions	23
Chapter 4 Configuration	24
Front Panel	24
Keys	25
Navigating the Weigh Mode	26
Enter the Weigh Mode	26
Enter or Exit the HOLD Mode	26
Zero	26
Tare	26
Preset Tare Weight	26
Clear Tare Weight	26
Output Data (print to a computer or printer)	27
Display Gross or Net Weight	27
Change Weight Unit	28
Check Weight (compare feature)	29
Navigating the Count Mode	29
Enter Count Mode	30

Obtain Piece Weight	30
Hold Function	31
Activate the Hold Function	31
Access the Hold Mode	31
Hold Methods	32
Display Software and Hardware Version	33
Display Test	33
Keyboard and Buzzer Test	34
Serial Port 1/2 (COM1/2) Receiving Test	34
Serial Port 1/2 (COM1/2) Transmitting Test	34
Chapter 5 Setup Mode	35
Entering the Setup Menu	35
Navigating the Setup Menu	35
Setup Menu Parameters	36
CONFIG Menu	36
USER Menu	41
CAL Menu	51
MISC Menu	53
TEST Menu	53
Exit the Setup Menu	54
Chapter 6 Calibration	55
Enter the Calibration Mode	55
Zero Point	55
Linearity	56
Geographical Adjustment	57
Gravity Value	59
Input or View Calibration	59
Weight Fine-tune	60
Display ADC Output Code	60
Chapter 7 Serial Communication	61
Communication Settings	61
Com Port 1	62
Com Port 2	62
Protocol	62
Transaction String	62
Commands and Response	63
Parameter NCI-SCP01	63
Parameter ECR-SCP02	66
Parameter 8213-SCP03	69
Parameter Multi	72
Parameter EH-SCP (PS-60)	74
Parameter IBM	75
Chapter 8 Legal for Trade	78
Physical Seal	78
Audit Trail Parameters	79
View Configuration Counter	79
View Calibration Counter	79
Chapter 9 Troubleshooting	80
Display Characters	80
Display Symbols	81
Error Messages and Troubleshooting	82

1 General Information and Warnings

1.1 About this Manual

This manual is divided into chapters by the chapter number and the large text at the top of a page. Subsections are labeled as shown by the 1 and 1.1 headings shown above. -The names of the chapter and the next subsection level appear at the top of alternating pages of the manual to remind you of where you are in the manual. The manual name and page numbers appear at the bottom of the pages.

1.1.1 Text Conventions

The keys used to interface with the 67XXU are located on the front panel of the indicator. The keystrokes are shown in **BOLD** incased between brackets. (e.g. **[ZERO]**)

Displayed messages appear in seven segment display type and reflect the case of the displayed message. (e.g. config)

1.1.2 Special Messages

Examples of special messages you will see in this manual are defined below. The signal words have specific meanings to alert you to additional information or the relative level of hazard.



CAUTION!

This is a Caution symbol.

Cautions give information about procedures that, if not observed, could result in damage to equipment or corruption to and loss of data.



ELECTRICAL WARNING!

THIS IS AN ELECTRICAL WARNING SYMBOL.

ELECTRICAL WARNINGS MEAN THAT FAILURE TO FOLLOW SPECIFIC PRACTICES OR PROCEDURES MAY RESULT IN ELECTROCUTION, ARC BURNS, EXPLOSIONS OR OTHER HAZARDS THAT MAY CAUSE INJURY OR DEATH.



NOTE: This is a Note symbol. Notes give additional and important information, hints and tips that help you to use your product.

1.2 Warnings

- Avoid lengthy exposure to extreme heat or cold. Your scale works best when operated at normal room temperature. Always allow the scale to acclimate to a normal room temperature before use.
- Allow sufficient warm up time. Turn the scale on and wait for a few minutes if possible. This will give the internal components a chance to stabilize before weighing.
- These electronic scales are precision instruments. Do not operate near an in-use cell phone, radio, computer or other electronic device. These devices emit RF and can cause unstable scale readings. If your scale ever performs poorly, try moving the scale to a different room or location.
- Avoid using in heavy vibration and airflow conditions.
- Read the weight reading in short time after loading. The output signature of load cell and electronic circuit may be little influenced after weighing for a long time.

1.3 Routine Maintenance



IMPORTANT: *This equipment must be routinely checked for proper operation and calibration. Application and usage will determine the frequency of calibration required for safe operation.*

Always turn off the machine and isolate from the power supply before starting any routine maintenance to avoid the possibility of electric shock.

1.4 Sharp Objects

Do not use sharp objects such as screwdrivers or long fingernails to operate the keys.

1.5 Cleaning the Indicator

Table 1.1 Cleaning DOs and DON'Ts



DO	DO NOT
Wipe down the outside of standard products with a clean cloth, moistened with water and a small amount of mild detergent	Attempt to clean the inside of the indicator
	Use harsh abrasives, solvents, scouring cleaners or alkaline cleaning solutions
Spray the cloth when using a proprietary cleaning fluid	Spray any liquid directly on to the display window

2 Installation



DANGER: RISK OF ELECTRICAL SHOCK. BE SURE TO UPLUG THE INDICATOR BEFORE REMOVING THE COVER OR OPENING THE UNIT. REFER TO QUALIFIED SERVICE PERSONNEL FOR SERVICE.

1. Unpack the scale and all components from the shipping box.
2. Remove the shipping screw from the under side of the scale base. Refer to [Figure 2.1](#).

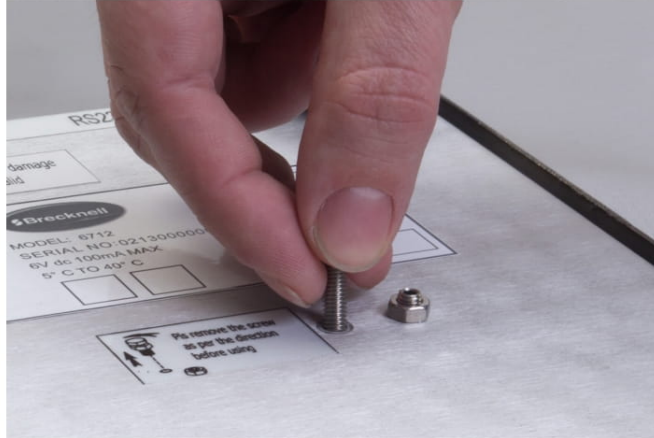

Figure 2.1 Shipping Screw Location

3. Connect all necessary cables to the proper connectors. Refer to this section for connection details.
4. Level the scale base using the four leveling feet. View the level bubble located under the platform top.

2.1 Connections

There are connectors located on the side of the scale for the power supply, USB port, RS-232 serial port and display which is used for mounting the display remotely on a wall or a desk.

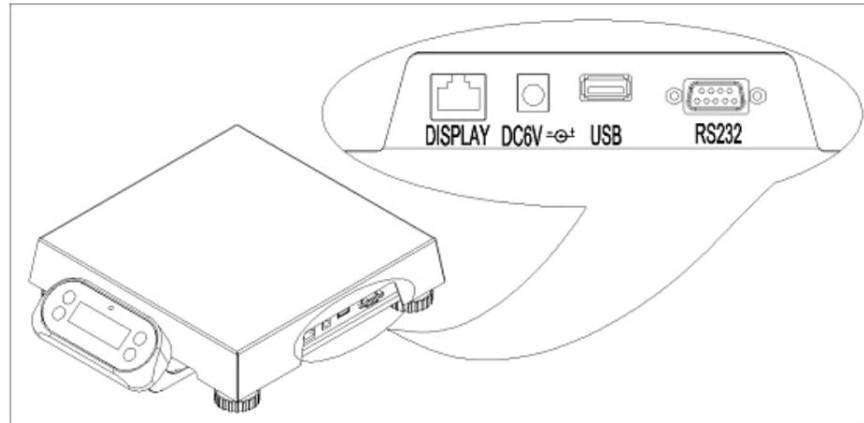

Figure 2.2 View of Scale Connectors

2.1.1 Display

The indicator display can be removed from the scale and mounted on a wall or desk. Refer to section 2.4 for details on mounting.

2.1.2 Power Supply

The 67XXU comes with an external AC to DC power adapter. Simply plug the AC adapter into the DC6V power jack on the scale and then plug into a standard wall outlet.



IMPORTANT: Make sure that the AC voltage and polarity appearing at the wall outlet matches the input voltage as well as the polarity marked on the AC adapter.

2.1.3 USB Port (Com 1)

The USB connector is used as a virtual RS-232 port and USB power supply.

2.1.4 RS-232 Serial Port (Com 2)

The 67XXU comes standard with one full Bi-directional RS-232 serial port designed for connection to either a PC or a serial printer.

- Pin 2 = transmit
- Pin 3 = receive

The RS-232 port connector is a 9-pin female.

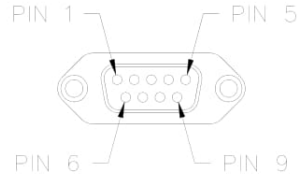

Figure 2.3 RS-232 Connector (Com 2)

2.2 Column and Remote Display Mounting

A column mounting kit (P/N 816965005963) is used to mount the remote display to the scale base on a column. Refer to the instructions below for column and remote display installation.

1. Remove the cable hold down strap from the bottom of the column by unscrewing the two screws which hold the cable strap in place. Set aside for use in a later step.

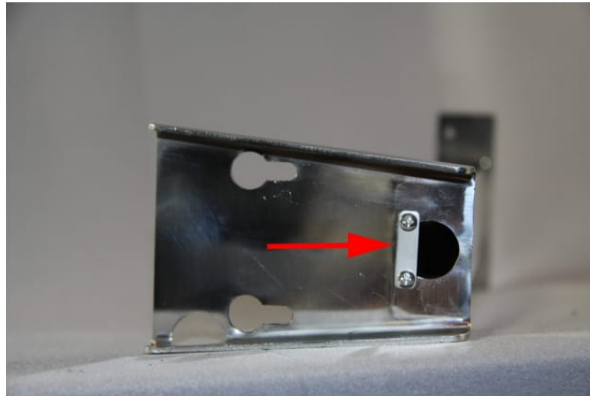

Figure 2.4 Cable Hold Down Strap

2. Remove the screws from the back of the remote display. Set aside for use in a later step.

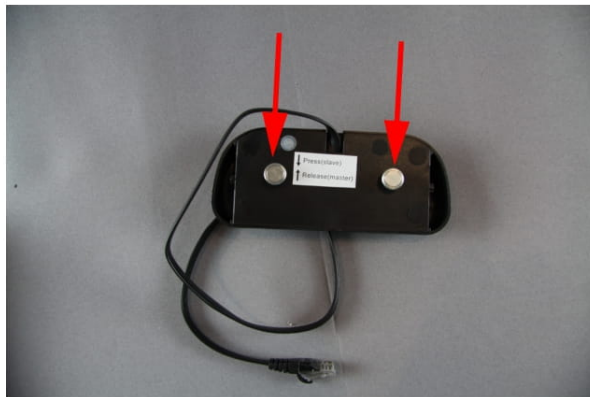

Figure 2.5 Display Screws

3. Run the display cable down the inside of the column using the hole on the top side of the column and pull the cable through the bottom hole.



Figure 2.6 Route Display Cable

4. Attach the display to the column by using the screws removed from the remote display in step 2.



Figure 2.7 Remote Display Attached to Column

5. Secure the cable to the column with the cable hold down strap that was remove in step 1.



Figure 2.8 Cable Hold Down Strap

6. Turn the scale base over to expose the under side. Locate the column screw holes.



Figure 2.9 Under Side of Scale Base

7. Install the two screws included with the kit into the screw holes leaving them somewhat loose.



Figure 2.10 Column Screws

8. Place the column bottom over the screws and push the column forward. Secure the column by tightening the screws.



Figure 2.11

9. Plug the remote display cable into the DISPLAY port.



Figure 2.12 Display Port

10. Turn the scale upright.

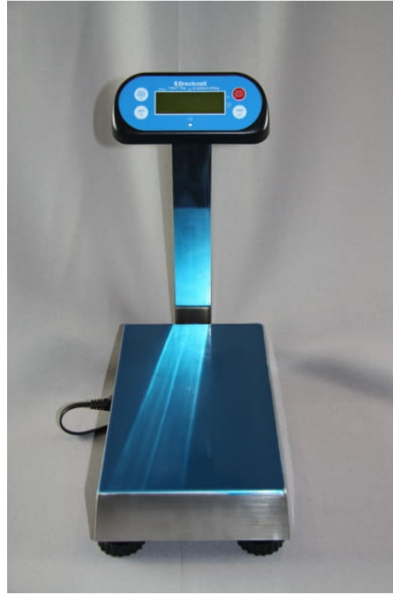

Figure 2.13 Column and Remote Display Installed

2.3 Mounting the Display to the Scale Base

The bracket mounts the remote display to the scale base.

1. Pull the remote display cable through the rectangle cut out in the display bracket.



Figure 2.14 Display Cable Routing

2. Clip the display to the bracket.

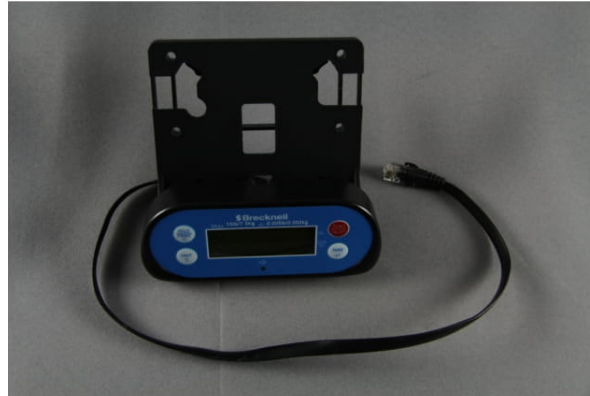

Figure 2.15 Display Attached to the Bracket

3. Pull the cable all of the way through.



Figure 2.16 Display Cable

4. Wrap the display cable around the four corners of the bracket. Pull cable through the center holes..



Figure 2.17 Cable Routing

5. Remove the top shroud and turn the scale base over to expose the under side. If a shipping screw is installed, it must be removed.

- Line up holes of the bracket with the holes on the scale base. Fasten the bracket down with the four provided screws.

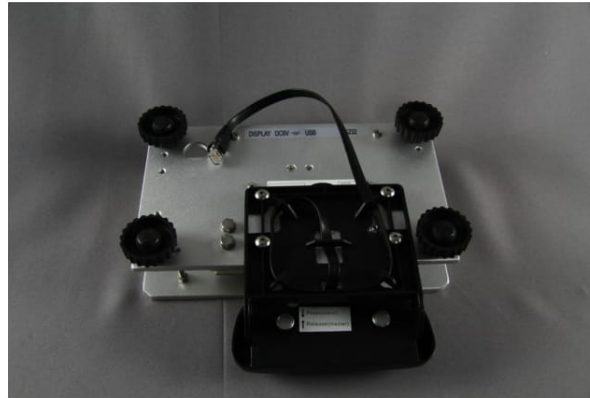

Figure 2.18 Bracket Installation

- Route the display cable through the opening of the scale base and plug the display cable into the DISPLAY port underneath.

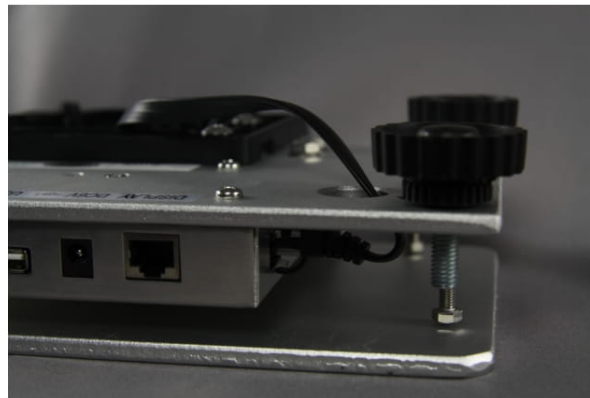

Figure 2.19 Display Port

- Turn the scale upright.

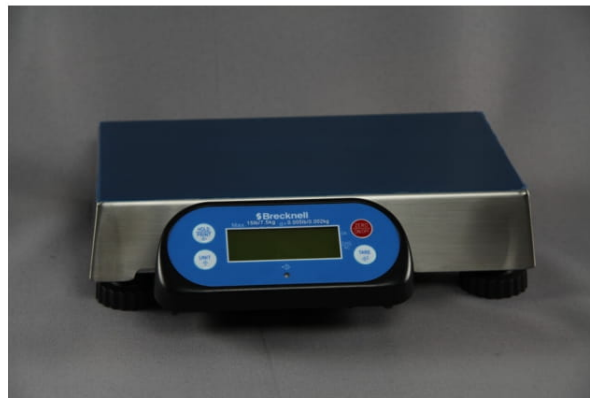

Figure 2.20 Scale with Attached Display

2.4 Desktop and Wall Display Mounting

The indicator is connected to the front of the 67XXU. It can be removed however to accommodate mounting on a wall or desk. Plug the display cable into the *DISPLAY* connector.

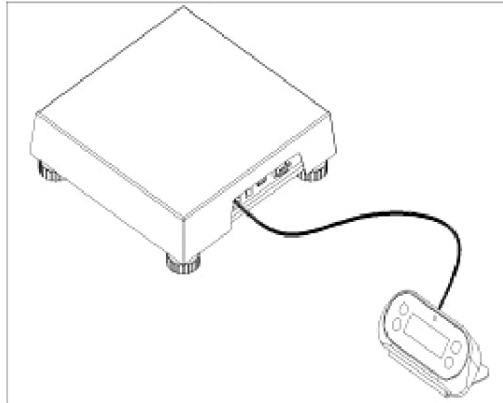

Figure 2.21 Indicator Desk Mount

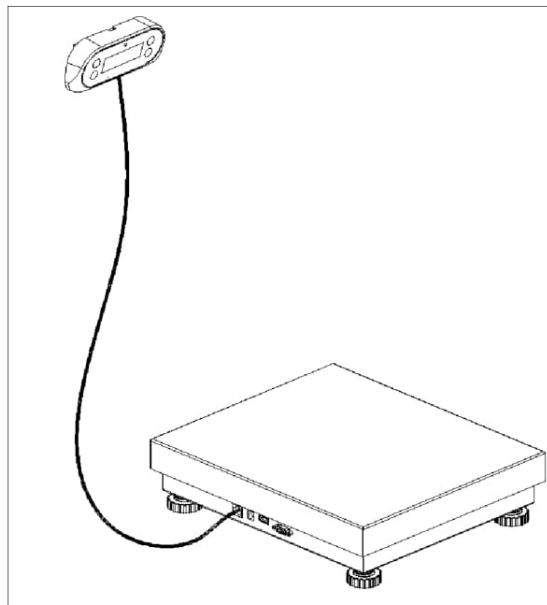

Figure 2.22 Indicator Wall Mount

2.5 Mainboard

Figure 2.23 shows the main board connectors for the loadcell, RS-232 port, USB port, power supply and battery.

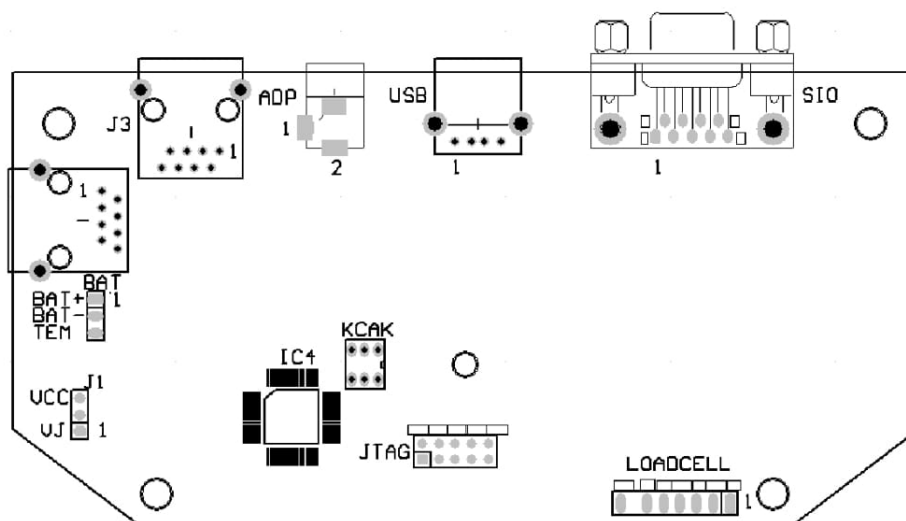

Figure 2.23 67XXU Main Circuit Board

2.5.1 Definition of Connectors and Jumpers

Table 2.1 Loadcell Connector

Pin	Description	In/Out/Power	Electrical Level
1	+ excitation	power output	5±0.3 VDC (≤0.12A)
2	+ sense	power input	5±0.3 VDC
3	- excitation	power ground	0 VDC
4	- sense	power input	≤0.5 VDC
5	+ signal	signal input	2.5±0.3 VDC
6	- signal	signal input	2.5±0.3 VDC
7	shield	-	-

Table 2.2 Adapter Power Input Connector (ADP)

Pin #	Definition	In/Out/Power	Electrical Level
1	Adapter input voltage - (GND)	Power ground	0VDC
2	Adapter input voltage +	Power input	6.5 VDC (6-9VDC, ≥0.5A)

Table 2.3 USB Connector (USB) Com 1

Pin	Description	In/Out/Power	Electrical Level
1	GND of VDD	power ground	0 VDC
2	USB D+		0-5 VDC
3	USB D-		0-5 VDC
4	USB power	power input	5±0.25 VDC

Table 2.4 RS-232 Port Connector (SIO) Com 2

Pin	Description	In/Out/Power	Electrical Level
2	RS-232 transmit on UART0	Output	-12 to +12 VDC
3	RS-232 receive on UART0	Input	-12 to +12 VDC
5	GND	Power ground	0 VDC

Table 2.5 CAL Jumper Set

Connected Pins	Function
Push	calibration enabled
No push	calibration disabled

3 Specifications

3.1 Available Models

6702U	6"x10" (15 or 30 lb)
6710U	10"x10" (15 or 30 lb)
6720U	12"x14" (15 or 30 lb)

3.2 Outline Dimensions

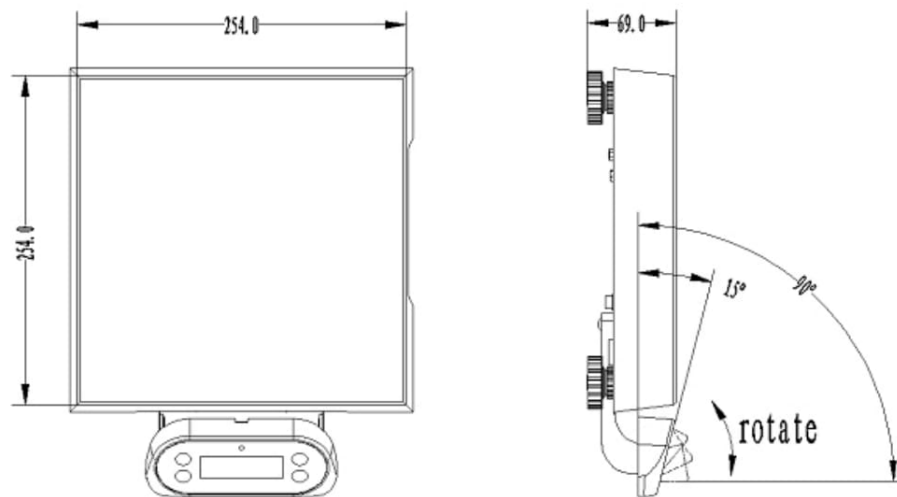

Figure 3.1 67XXU Dimension Drawing

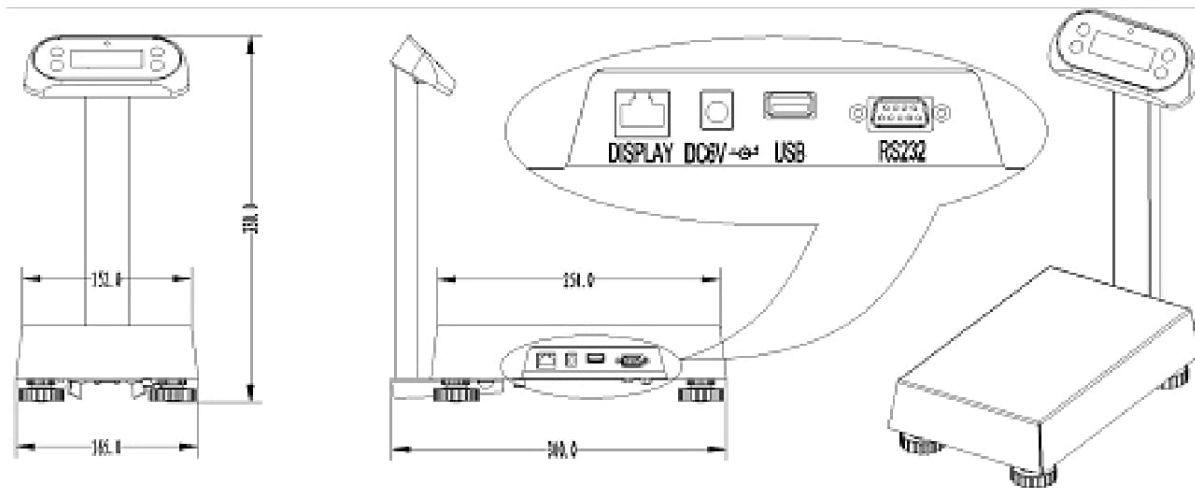

Figure 3.2 67XXU Dimension Drawing with Indicator on a Column

3.3 Mounting

- Bracket
- Remote (optional cable required)
- Column (option kit required)

3.4 Power Supply

- AC Adapter: 7-9VDC, ≥500mA, center positive
- USB power supply if USB interface is installed
- Work current: ≤15mA (with backlight off, and no load cells)
 - ≤30mA (with backlight on, and no load cells)
 - ≤50mA (with backlight on and one 350 load cell)

3.5 Display

- 5 1/2-digit, 7-segment, 0.58" (15mm) LCDs

3.5.1 Keypad

- 4 push buttons

3.5.2 Environment

Working temperature	-10°C to 40°C
Storage temperature	-20°C to 70°C
Humidity	10 to 90% RH without condensation

3.5.3 Load Cell Excitation

Voltage	5VDC
Max. Current	20mA

3.6 Approvals

NTEP	13-074
Measurement Canada	AM-5912C

3.7 Communication

Serial port1	Full-duplex RS-232
Optional Serial Port	USB (Virtual RS-232)
Baud Rate	Selectable: 1200-2400-4800-9600-19200-38400 bps
Data Output Format	8N1, 7O1, 7E1
Protocol	programmable

3.8 Analog Circuitry

- 24-bit A/D converter
- Conversion Speed: 10Hz
- Input range: -15mV to +15mV
- Output code: 1mV input will output about 100,000 raw counts
- Hardware low pass filter and 2 programmable digital low pass filters

3.9 Capacity and Division

- Programmable
- Max display range: -199,999 to 199,999
- Division number range for primary unit: 100-20,000
 - Division number range for second unit: 100-25,000 (division number will be limited by REGUL setting)
- Recommended Sensitivity: >1μV/ display division

3.10 Accuracy

≤0.01%

3.11 Calibration Method

- Software calibration with long-term storage in EEPROM
- Provides smooth curve fit through four points
- Calibration can be done under kg or lb weight unit with 10% -100%FS standard weight.
- Weight fine adjustment (± 10%)
- Geographic adjustment

3.12 Other Main Functions

- Programmable zero range
- Programmable pre-set tare weight
- Programmable automatic zero point tracking
- Programmable motion detection window
- Programmable auto-power off time, backlight working mode
- Programmable hold function with peak weight holding and dynamic weighing
- Available check weighing mode
- Available parts counting mode
- Available units of measure: kg, lb, lb:oz, oz, g, PCS
- Data comparison and indicator in weighing mode and parts counting mode
- Programmable serial output content

4 Configuration

To set up the indicator, you must first enter the appropriate menu mode. The front panel keys become directional navigators to move around in the menus. See [Table 4.2](#) for details.

4.1 Front Panel

The front panel incorporates the display and keypad.

The annunciators used are incorporated in the display. The annunciator will be lit when the mode is active.

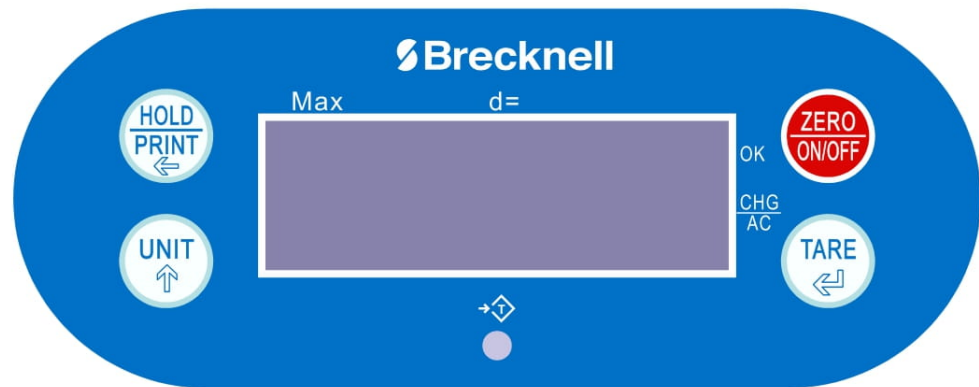

Figure 4.1 67XXU Keypad and Display

Table 4.1 LCD Display Annunciators and Definitions

LCD Annunciator	Description
⇒ 0 ⇐	Better known as the "Center of Zero" annunciator. It is lit when the scale is at the zero point and the gross weight is 0.
NET	Indicates net mode and the tare weight is not 0.
lb	Indicates the current unit of measure is lb.
oz	Indicates the current unit of measure is oz.
kg	Indicates the current unit of measure is kg.
g	Indicates the current unit of measure is g.
Pcs	Indicates counting mode. Unit of measure is pieces.
HOLD	Flashes when HOLD key is pressed. Remains permanently on when the Hold function has become activated.
AC/CHG	When battery is being used or charged, is fully charged or not installed.
OK	Indicates when data compare is enabled and current data (weight, pieces or percent) is between the specified upper and lower limits.

4.2 Keys

The keyboard consists of four keys, some of which have multiple functions.

Table 4.2 Function of the Keys

Key	Mode	Condition	Function
	Weigh or count	Press for less than 3 seconds	Enter or exit HOLD/PRINT mode
	Weigh or count	Press [HOLD] + [ON/OFF] for more than 3 seconds	Enter setup mode
	Input data mode	Press for more than 3 seconds	Input decimal point
	Input data mode	Press for less than 3 seconds	Rotate the flashed position from right to left
	Menu selection mode		Select next item of current menu
	Weigh or count	Press [HOLD] + [UNIT] for more than 3 seconds	Select working mode (weigh or count)
	Weigh mode	Press for less than 3 seconds	Change weighing units: kg->lb->oz lb:oz (not available in some conditions) g (not available in some conditions) kg (not be available in some conditions)
	Count mode	Press for less than 3 seconds	To enter piece weight mode (by way of sample or input directly)
	Weigh or count	Press for more than 3 seconds	To input compare data (for weight or pieces) of high and low limitation
	Display voltage mode	Press for more than 3 seconds	To calibrate input voltage value
	Display ADC code mode		Select displaying code from: no-filter, filter1, filter2
	Input data mode	Press to enter data	one will be added to the flashing digit
	Menu selection mode		Select next item of current menu
	Weigh or count	Press for less than 3 seconds	Tare function
	Weigh or count	Press for more than 3 seconds	Input pre-set tare weight at selected weight unit
	Input data mode or Menu selection mode	Press to enter data	To confirm input data or current item selection. Select next item of current menu or next operation
	Display ADC code mode		Set or clear tare code
	Power off mode		Power on
	Count or weigh	Press for less than 3 seconds	Zero function
	Count or weigh	Press for more than 3 seconds	Power off
	Input data		Ignore current operation
Menu selection mode		Return to last sub-menu	



NOTE: To access the second function of the key, press and hold the key for more than 3 seconds.

4.3 Navigating the Weigh Mode

4.3.1 Enter the Weigh Mode

Press the [HOLD] + [UNIT] keys for 3 seconds. Use the [UNIT] key to choose the desired mode and the [TARE] key to confirm selection and exit to the chosen mode.

4.3.2 Enter or Exit the HOLD Mode

Press the [HOLD] key for 3 seconds.

4.3.3 Zero

When the weight is stable and within the zero range, press the [ZERO] key to set a new zero point. Refer to [Table 4.3](#) for zero limitations.

4.3.4 Tare

When the gross weight is larger than zero and the scale is stable, press the [TARE] key. The indicator will show a net weight of zero and the NET annunciator will be illuminated. Refer to [Table 4.3](#) for tare limitations.

4.3.5 Preset Tare Weight

Enter a preset tare weight by pressing the [TARE] key for more than 3 seconds. Pr.Tar will be displayed and the NET annunciator flashes. Use the [UNIT] and [TARE] key to input the desired tare weight and the [HOLD] key to move to the next digit. The value entered must be larger than zero and there is no limitation to preset tare weight. After the tare weight is entered the NET annunciator will illuminate. Refer to [Table 4.3](#) for tare limitations.

Note: This indicator can only save one tare weight. The new tare weight will automatically replace the old one.

4.3.6 Clear Tare Weight

Remove any weight on platform and wait until the scale is stable. Press the [TARE] key.

Table 4.3 Zero and Tare Limitations

Standard	Weight on platform	Data in TARE memory unit	key function	
			Tare key	Zero key
USA	≤0	no	No action	Zero
		yes	Clear the tared weight	
	>0	no	Tare	
		yes		

Standard	Weight on platform	Data in TARE memory unit	key function	
			Tare key	Zero key
Canada	≤0	no	No action	Zero
		yes	Clear the tared weight	
	>0	no	Tare	
		yes	No action	
Europe	≤0	no	No action	Zero
		yes	Clear the tared weight	Zero and clear the tared weight
	>0	no	Tare	Zero
		yes		Zero and clear the tared weight
None (same with Europe)	≤0	no	No action	Zero
		yes	Clear the tared weight	Zero and clear the tared weight
	>0	no	Tare	Zero
		yes		Zero and clear the tared weight



Zero can only be active when the scale is stable and weight is in SAZSM setting range.

Tare can only be active when the scale is stable.

Clearing the Tare weight or Zeroing the scale will put the indicator into Gross mode.

Adding a Tare weight will put the indicator into Net mode.

4.3.7 Output Data (print to a computer or printer)

When scale is stable press the **[PRINT]** key.

4.3.8 Display Gross or Net Weight

- If the tare weight is not zero, the Net weight will be displayed.
- If the tare weight is zero, Gross weight will be displayed.

4.3.9 Change Weight Unit

Press the **[UNIT]** key to select kg, lb, oz, lb:oz, g. Note: under some conditions oz, lb:oz, g are not available. Please refer the following tables.

Table 4.4 Use kg as Primary Unit

Calibration Division Value	Display Division Value				
	kg	g	lb	oz	lb:oz
0.0001kg	0.0001kg	0.1g	0.0002lb	0.005oz	Not available
0.001kg	0.001kg	1g	0.002lb	0.05oz	Not available
0.01kg	0.01kg	10g	0.02lb	0.5oz	0.5oz
0.1kg	0.1kg	Not available	0.2lb	5oz	Not available
1kg	1kg	Not available	2lb	Not available	Not available
0.0002kg	0.0002kg	0.2g	0.0005 lb	0.01oz	Not available
0.002kg	0.002kg	2g	0.005 lb	0.1oz	0.1 oz
0.02kg	0.02kg	20g	0.05 lb	1oz	1 oz
0.2kg	0.2kg	Not available	0.5 lb	10oz	Not available
2kg	2kg	Not available	5 lb	Not available	Not available
0.0005kg	0.0005kg	0.5g	0.001 lb	0.02oz	Not available
0.005kg	0.005kg	5g	0.01 lb	0.2oz	0.2 oz
0.05kg	0.05kg	50g	0.1 lb	2oz	2oz
0.5kg	0.5kg	Not available	1 lb	Not available	Not available
5kg	5kg	Not available	10 lb	Not available	Not available

Table 4.5 Use lb as Primary Unit

Calibration Division Value	Display Division Value				
	kg	g	lb	oz	lb:oz
0.0001lb	Not available	Not available	0.0001lb	0.002oz	Not available
0.001 lb	0.0005 kg	0.5g	0.001 lb	0.02oz	Not available
0.01 lb	0.005 kg	5g	0.01 lb	0.2oz	0.2 oz
0.1 lb	0.05 kg	50g	0.1 lb	2oz	2 oz
1 lb	0.5 kg	Not available	1 lb	Not available	Not available
0.0002 lb	0.0001 kg	0.1g	0.0002 lb	0.005oz	Not available
0.002 lb	0.001 kg	1g	0.002 lb	0.005oz	Not available
0.02 lb	0.01 kg	10g	0.02 lb	0.5oz	0.5 oz
0.2 lb	0.1 kg	Not available	0.2 lb	5oz	Not available
2 lb	1 kg	Not available	2 lb	Not available	Not available
0.0005 lb	0.0002 kg	0.2g	0.0005 lb	0.01oz	Not available
0.005 lb	0.002 kg	2g	0.005 lb	0.1oz	0.1 oz
0.05 lb	0.02 kg	20g	0.05 lb	1oz	1 oz
0.5 lb	0.2 kg	Not available	0.5 lb	10oz	Not available
5 lb	2 kg	Not available	5 lb	Not available	Not available

4.3.10 Check Weight (compare feature)

To make the weight compare function available, set CONFIG-FUNC-COMPAR item to YES (refer to Chapter 5 for details on entering and navigating the setup mode). The high and low limitation of weight should be set correctly according to following steps:

1. In weighing mode or count mode, press the **[UNIT]** key more than 3 seconds to compare the high and low data.
 - 1a. If in the weigh mode and the *COMP* parameter is accessed, unt.lb or unt.kg will be displayed when in the weigh mode. Use the **[UNIT]** key to change the active unit.
 - 1b. If in the count mode, go to step 3.
2. Use the **[TARE]** key access the high value. high and then L0000 will be displayed.
3. Use the **[UNIT]** and **[HOLD]** keys to enter the high value. Note: The **[UNIT]** key changes the flashing digit. The **[HOLD]** key goes to the next digit.
4. Press the **[TARE]** key to confirm the entry.
5. After Low is accessed, L0000 will be displayed. Use the **[HOLD]** and **[UNIT]** keys to input the low number.
6. Press the **[TARE]** key to confirm.
- 6a. After a reasonable limitation is set and compare is active, one of annunciators OK will be illuminated. The beeper will sound according to its setting in USER-BEEP.
7. Press the **[ZERO]** key to exit the *Comp* mode.



NOTE: If the High number value is 0 or is equal or less than low number, the comparison will be disabled, and the input data has no limitation.

4.4 Navigating the Count Mode

In this mode, the scale will weigh goods, calculate and display its counts after the piece weight of the goods is obtained. The count function must be enabled in the setup mode. The CONFIG-FUNC-COUNT item should be set to YES in CONFIG menu. Refer to Chapter 5 for details on entering and navigating the setup mode.

4.4.1 Enter Count Mode

1. To enter counting mode press the **[HOLD] + [UNIT]** keys for more than 3 seconds. WEIGH will be displayed.
2. Use the **[UNIT]** key to select COUNT.
3. Press **[TARE]** to confirm the parts counting mode. The PCS annunciator will be illuminated.
 - 3a. In counting mode, the function of **[ZERO]**, **[TARE]**, **[PRINT]**, **[ON/OFF]** and **[HOLD]** keys are available.

4.4.2 Obtain Piece Weight

There are two ways to obtain the piece weight:

Input Piece Weight Directly

1. Press the **[UNIT]** key.
2. When InP.PW is displayed, press the **[TARE]** key to enter into the piece weight mode.
3. When UNIT.KG is shown, use the **[UNIT]** key to select the unit of piece weight.
4. Use the **[TARE]** key to confirm and go to piece weigh entry. The display will show L0001 (Note: Since the LCD can only show 4 digits, but the software allows 6 digits total, so there will be separate displays: L0001 and H00, L0001 displays the low position digits and H00 displays the high position digits).
5. From the L0001 display, use **[HOLD]** and **[UNIT]** key to input new piece weight.
 - 5a. Press the **[UNIT]** key to increase the numbers.
 - 5b. Press the **[HOLD]** key to change the flashed position.
 - 5c. Press the **[HOLD]** key more than 3 seconds to input decimal point.
 - 5d. If the input piece weight is less than 0.5d, the indicator will display PWt.Er and go back to counting mode.
6. Press the **[TARE]** key to confirm the entry.
7. Press the **[ZERO]** key to exit the piece weight mode and back to counting mode.

Sample a Known Quantity

1. Press the **[UNIT]** key.
2. When In.PWt is shown, use the **[UNIT]** key to select SPL.Lo.
3. Press the **[TARE]** key to weigh samples (which quantity is known) weight, calculate piece weight.
4. When SPL.Lo is shown, remove the sample on scale and press the **[TARE]** key to confirm. Before scale is stable, SPL.Lo will be flashed. After it is stable, it will go to next step.
5. When SPL.Hi is shown, put samples (if quantity is known) onto the scale, Press the **[TARE]** key to confirm reading weight. Before scale is stable, SPL.hi will be flashed. After it is stable, it will go to next step.
 - 5a. If the calculated piece weight is less than 0.5d, the indicator will display PWt.Er and go back to counting mode. Otherwise, after the reasonable piece weight has been captured, the scale will go back to counting mode. The piece weight will be saved and used again.
6. After IN.PCS shown, L0000 will be displayed.
7. Use the **[UNIT]** and **[HOLD]** keys to input the quantity of samples.
8. Press the **[TARE]** key to confirm the entry.

- 8a. If the calculated piece weight is less than 0.5d, the indicator will display PWt.Er and go back to counting mode. Otherwise, after the reasonable piece weight has been captured, the scale will go back to counting mode. The piece weight will be saved and used again.
9. Press the **[ZERO]** key to exit and back to counting mode.

4.5 Hold Function

The HOLD function can be used to freeze a displayed number. In this mode, the scale can capture a dynamic number, hold a stable number, or average a unstable number and then HOLD (freeze) this number temporarily for the user to view or record.

The HOLD function can be used in normal weighing mode and counting mode. After entering HOLD mode, the speed of A/D converter can be increased to 80Hz (if USER-HOLD-AD.H.SP is set to YES) from original 10Hz for some dynamic weighing applications.

It is possible to weigh restless samples such as live animals or moving objects within the HOLD function. The indicator provides special mode settings to accommodate weight movements.

4.5.1 Activate the Hold Function

- The CONFIG-FUNC-HOLD menu item must be set to YES.

Menu items of:

- USER-HOLD-HLD.MD /AVG.TM /HLD.TM/RG /STB.TM
- USER-OTHER-NLD.RG need be set to reasonable values.
- To speed up sampling of weight, set USER-HOLD-AD.H.SP menu item to YES.

4.5.2 Access the Hold Mode

To enter the HOLD mode, press the **[HOLD]** key while in the normal weighing mode or counting mode.

4.5.3 Hold Methods

- Positive Peak Number HOLD mode
- Negative Peak Number HOLD mode
- Toggle HOLD mode
- Average HOLD mode
- Auto HOLD mode

The following are details of these HOLD modes:

Positive Peak HOLD

When USER-HOLD-HLD.MD is set to PS.PEK, the hold mode is positive peak hold mode.

When scale first enters this working mode, it will display the largest positive number that is from the time of zero-point set. The scale also will always catch the largest positive number and display it.

To exit HOLD mode, press the **[HOLD]** key again.

Negative Peak HOLD

When USER-HOLD-HLD.MD is set to NG.PEK, the hold mode is in negative peak hold mode.

When the scale first enters this mode, it will display the largest negative number from the time of zero-point set. The scale also will always catch the largest negative number and display it.

To exit HOLD mode, press the **[HOLD]** key again.

Toggle HOLD

When USER-HOLD-HLD.MD is set to TOGGLE, the hold mode is toggled between HOLD and MANUAL HOLD function.

After entering this mode, the scale will freeze and display a number if scale is stable. Only the weight that is over USER-OTHER-NLD.RG (zero 'dead' band) can be held.

To exit HOLD mode, press the **[HOLD]** key again. If the time of the scale being unstable is more than USER-HOLD-STB.TM, STB.ER will be shown.

Press the **[TARE]** key to start averaging again or press the **[HOLD]** key to exit.

Average HOLD

Set the USER-HOLD-HLD.MD parameter to AVERG.

After entering this mode the scale will freeze and display number if the scale is stable. If the scale is not stable, but the variation is less than the USER-HOLD-DYN.RG setting, the scale will average data in USER-HOLD-AVG.TM, then freeze and display the number. Only the weight that is over USER-OTHER-NLD.RG can be frozen.

The scale will exit HOLD mode according to the setting of USER-HOLD-HLD.TM. If the time of scale variation is over USER-OTHER-NLD.RG and is more than USER-HOLD-STB.TM, STB.ER will be shown.

Press **[UNIT]** or **[TARE]** to start averaging again, or press the **[HOLD]** key to exit.

Auto HOLD

Set the USER-HOLD-HLD.MD parameter to AUTO. Different items can be weighed one after another without pressing any buttons.

After entering this working mode, scale will freeze and display number if scale is stable. Only the weight that is over USER-OTHER-NLD.RG can be frozen. If the held weight is moved away and a new load is put on the scale, the new load will automatically be held.

The scale will exit HOLD mode according to the setting of USER-HOLD-HLD.TM. If the time of scale variation being over USER-OTHER-NLD.RG is more than USER-HOLD-STB.TM, STB.ER will be shown. Press the **[TARE]** key to start averaging again or press the **[HOLD]** key to exit.

4.6 Display Software and Hardware Version

Display the current version of software and hardware.

1. Enter the Setup Mode by pressing the **[HOLD] + [ON/OFF]** keys until `confg` is displayed.
2. Use the **[UNIT]** key to select the MISC-VER menu.
3. Press **[TARE]** to display the current version.
- 3a. Firmware Version display Format is: `Vxx.yy`, `xx` is hardware version, `yy` is software version.
4. Press the **[ON/OFF]** key to return to last menu item.

4.7 Display Test

1. Press the **[HOLD] + [ON/OFF]** keys until `confg` is displayed.
1. Use the **[UNIT]** key to select TEST-DSP.TS menu.
2. Press **[TARE]** to enter the test display mode and all segments will light at first.
- 2a. In this mode, every press of the **[UNIT]** key will light the next segment. Every press of the **[HOLD]** key will light the next digit.
- 2b. Press the **[TARE]** key to automatically light all segments and all digits.
3. Press the **[ON/OFF]** key to return to last menu item.

4.8 Keyboard and Buzzer Test

1. Press the **[HOLD] + [ON/OFF]** keys until `confg` is displayed.
2. Use the **[UNIT]** key to select `TEST-KEY.TS` menu.
3. Press **[TARE]** to enter test keypad mode and key will be displayed.
4. Press any key. The value of this key will be displayed and the buzzer will beep.
5. Press the **[ON/OFF]** key to return to last menu item.

4.9 Serial Port 1/2 (COM1/2) Receiving Test

Before testing the receiving function of COM1 or COM2, a cable is need to connect a computer to the scale. A terminal program such as Hyper Terminal is also needed for testing.

Note: baud rate is selected by `USER-COM1/2-BUD.RT`, 8N1 byte format is fixed, Hex data (0x00 - 0xff) are used.

1. Press the **[HOLD] + [ON/OFF]** keys until `confg` is displayed.
2. Use the **[UNIT]** key to select `TEST-CM1.RD` or `TEST-CM2.RD` item.
3. Press **[TARE]** to enter test COM1/2 receiving function. `rd1.--` or `rd2.--` will be displayed.
- 3a. In this mode, received hex data (0x00 - 0xff) will be displayed in -- position.
4. Press the **[ON/OFF]** key to return to last menu item.

4.10 Serial Port 1/2 (COM1/2) Transmitting Test

Before testing the receiving function of COM1 or COM2, a cable is need to connect a computer to the scale. A terminal program such as Hyper Terminal is also needed for testing.

Note: baud rate is selected by `USER-COM1/2-BUD.RT`, 8N1 byte format is fixed, Hex data (0x00 - 0xff) are used.

1. Press the **[HOLD] + [ON/OFF]** keys until `confg` is displayed.
2. Use the **[UNIT]** key to select `TEST-CM1.TD` or `TEST-CM2.TD` item.
3. Press **[TARE]** to enter test COM1/2 transmit function. `td1.--` or `td2.--` will be displayed.
- 3a. In this mode, transmitted hex data (0x00 - 0xff) will be displayed in -- position.
4. Press the **[ON/OFF]** key to return to last menu item.

5 Setup Mode

The setup menu consists of five different sub-menus. Within each sub-menu are different menu options.

The config/cal switch must be set in the ON position in order to make changes to specific parameters.

5.1 Entering the Setup Menu



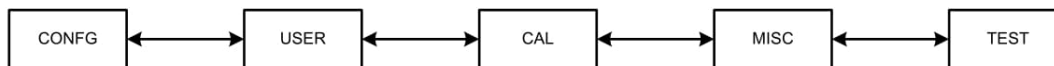

1. Power on the indicator by pressing and holding the **[ON/OFF]** key.
2. Press the **[HOLD] + [ON/OFF]** key for 3 seconds. The indicator shows **confg** to indicate that you are in Setup Menu mode.

5.2 Navigating the Setup Menu



1. Once **Confg** is displayed, use the **[UNIT]** key to move forward through the menu choices or the **[HOLD]** key to move backward in the setup menu.
2. Use the **[TARE]** key to access the desired menu. (e.g. User)
3. Use the **[UNIT]** key to view the available sub-menus (parameter: e.g. beep).
4. Use the **[TARE]** key to select the sub-menu.
5. Use the **[UNIT]** key to view the choices within the sub-menu. (e.g. key)
6. Press the **[TARE]** key to select the desired choice within the sub-menu. Once selected the parameter will be displayed.
7. Press **[ZERO]** to return back up and return to the setup menu.

Table 5.1 Key Navigation

[HOLD/PRINT] 	Access the Setup Menu.
[UNIT] 	Scroll through available menus.
	Choose a sub-menu Make a change within the sub-menu
[ZERO/ON/OFF] 	Scroll through available menus.
	Choose a sub-menu Make a change within the sub-menu
[TARE] 	Choose a sub-menu

5.3 Setup Menu Parameters

This section provides more detailed descriptions of the selections found in the Setup Menu.

The menu charts show the flow of the parameters and also provide a quick reference to the parameters within the menu.

The menu tables show the submenus, options and default parameter in LCD display format to coincide with the actual display.

5.3.1 CONFIG Menu

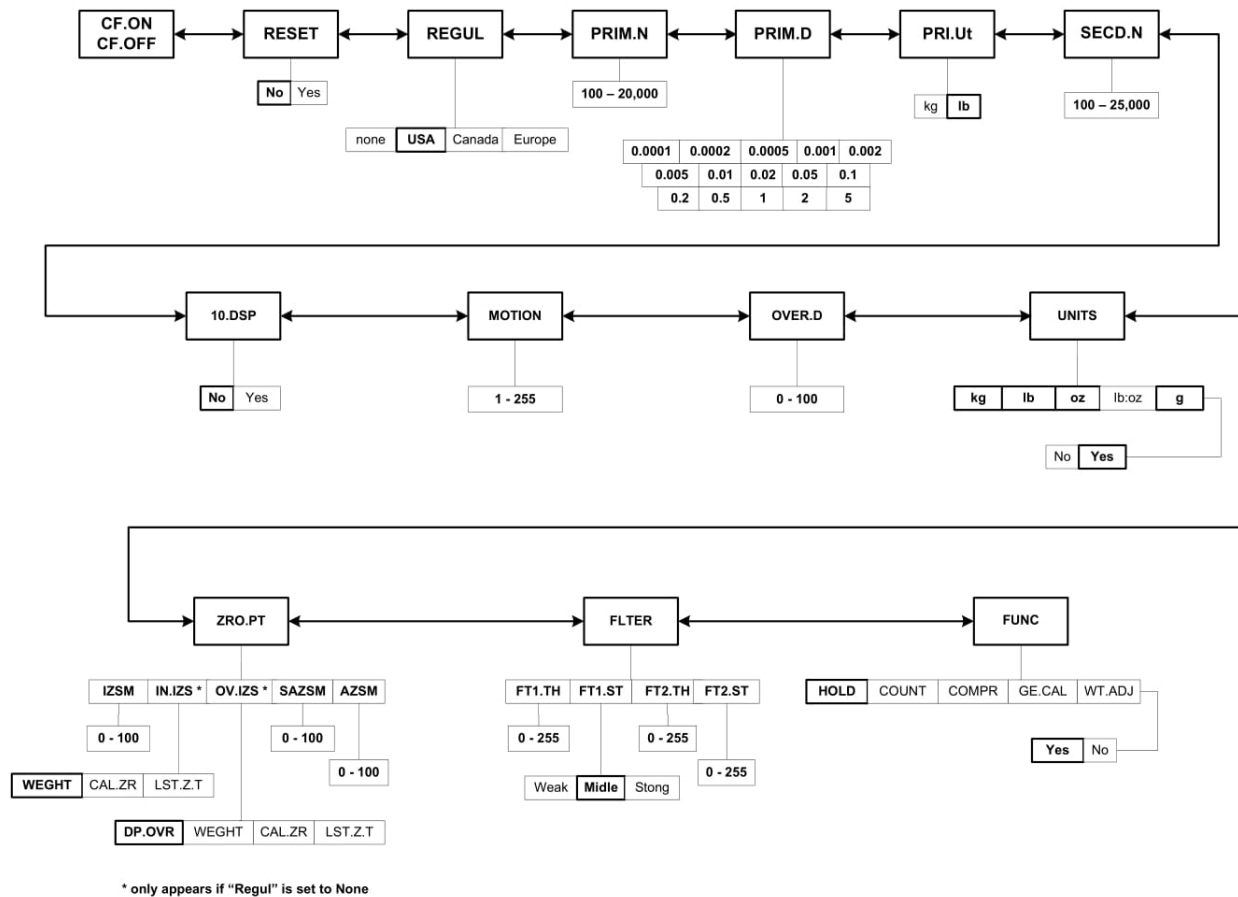

Figure 5.1 CONFIG Menu Chart

The figure above is an illustration of the available menus with the CONFIG menu and the choices within those menus. Refer to [Table 5.2](#) for explanations of the menu choices.

Table 5.2 CONFIG Menu Choices and Explanations

CONFIG					
SubMenu1	SubMenu2	Option	Default	Parameter Description	Comment
CF.ON CF.OFF				Seal switch position	The display will show whether the seal switch is in the ON or Off position. This parameter can't be changed within the software.
RESET		NO	NO	Reset Config menu parameters to default setting	
		YES			
REGUL		none	USA	Select the standard in which the scale will comply: USA, Canada, Europe	*None = not legal for trade.
		USA			
		Canda			
		Eurpe			
PRIM.N		100 - 20000		Primary full scale value	Default full scale value will depend on capacity of scale. *If (REGUL) ≠ none, the max is 10,000
PRIM.D		0.0001		The division value under primary unit	Default division size will depend on capacity of scale. The division value under second unit is automatically determined by the indicator according to the division value under primary unit.
		0.0002			
		0.0005			
		0.001			
		0.002			
		0.005			
		0.01			
		0.02			
		0.05			
		0.1			
		0.2			
		0.5			
		1			
2					
5					

CONFIG					
SubMenu1	SubMenu2	Option	Default	Parameter Description	Comment
PRIM.Ut		kg	lb	Primary unit	Select the primary unit from kg or lb. The second unit is lb if kg is selected as the primary unit. *The calibration standard weight must be in the primary unit!
		lb			
SECD.N		100-25000		Second scale full scale value	The division number under second unit. The maximum is $1.25 * (\text{PRIM.N})$. *If (REGUL)≠none, the max is 10,000 NOTE: Secondary division has to match the primary division.
10.DSP		NO	NO	Display weight at 10 times division number under primary unit	*If (REGUL)= none this parameter will not be available. When yes is selected, some menus will not be active.
		YES			
MOTON		1-255	4	Motion window	$1-255 = \pm 0.25d * (1-255)$ *If (REGUL)=none, the max is 12
OVER.D		0-100	0	Overload display limitation	$0 = \text{FS} + 9d$ $1-100 = 101\% \text{FS} - 200\% \text{FS}$. *If (REGUL)=none, the max is 10
UNITS	KG	yes	yes	UNITS key	YES = enable this unit No = disable this unit In trade applications, lb:oz is not allowed
		no			
	lb	yes	yes		
		no			
	oz	yes	yes		
		no			
	lb:oz	yes	no		
		no			
	g	yes	yes		
		no			

CONFIG					
SubMenu1	SubMenu2	Option	Default	Parameter Description	Comment
ZRO.PT	IZSM	0-100	10	Initial zero set mechanism	Range of capacity in percent ± 0 - 100%FS Also uses SAZSM and AZSM (total) *If (REGUL)=none, the max is 10
		WEGHT	WEGHT	Inside IZSM	WEIGHT= on power up
					CAL.ZR
	LST.Z.T	LST.Z.T=store last push button zero and push button tare *If (REGUL) ≠none, the value is fixed on WEIGHT			
	OV.IZS	DP.OVR	DP.OVR	Outside IZSM	DP.OVR=display initial zero is over. Display will show upper dashes when above capacity
					WEGHT
		CAL.ZR	CAL.ZR= calibration zero point will display dashes at 100%		
		LST.Z.T	LST.Z.T=Last ZERO and TARE		
	SAZSM	0-100	2	Zero key range	0=no limitation 1-100= (initial zero point) ±1%FS - (initial zero point) ±100%FS *If (REGUL) ≠none, the max is 2
	AZSM	0-100	8	Zero tracking window	0=0d, no tracking 1-100=±(0.2+0.05*(1-100))d /s *If (REGUL) ≠none, the max is 4
FLTER	FT1.TH	0-255	40	Digital filter1 threshold	0=no filter1 1-254=filter1 used only when vibration in ±0.25d*(1-254) 255= filter1 always used
	FT1.ST	weak	midle	Digital filter1 intensity	Weak = 4 weights to average Midle = 8 weights to average Strong = 16 weights to average
		midle			
		stong			
	FT2.TH	0-255	8	Digital filter2 threshold	0=no filter2 1-254=filter2 used only when vibration in ±0.25d*(1-254) 255= filter2 always used
FT2.ST	0-255	240	Digital filter2 intensity	0-255=weak to strong	

CONFIG					
SubMenu1	SubMenu2	Option	Default	Parameter Description	Comment
FUNC	HOLD	YES	YES	Enable or disable hold function	YES
		NO			NO
	COUNT	YES	NO	Enable or disable counting function	YES
		NO			NO
	COMPR	YES	no	Enable or disable data comparison function	YES
		NO			NO
	ge.cal	yes	NO	Enable or disable the geographical adjustment factor	YES
		no			NO
	WT.ADJ	YES	NO	Enable or disable weight fine-tuning using keypad in weighing mode	YES
		no			NO

***The setting will be limited by the choice of REGUL**

5.3.2 USER Menu

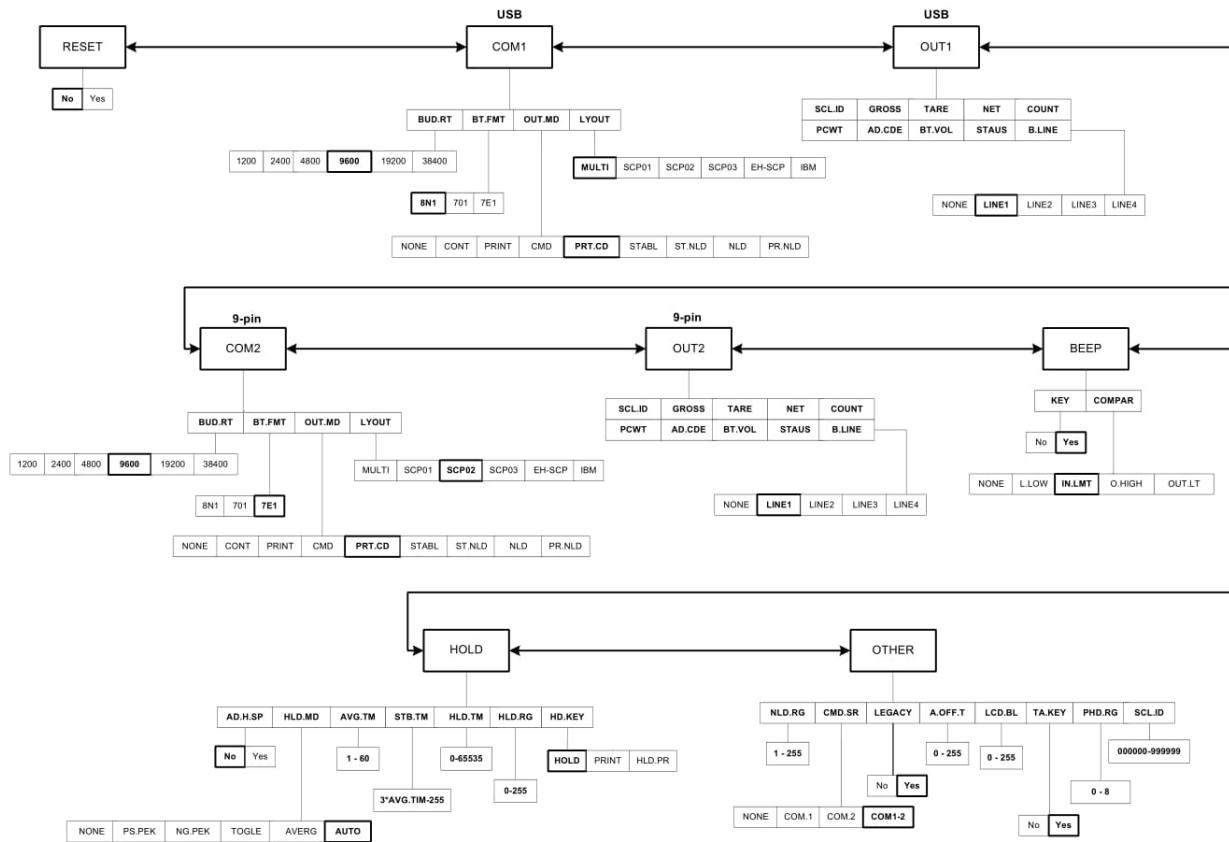

Figure 5.2 USER Menu Chart

The figure above is an illustration of the available menus with the USER menu and the choices within those menus. Refer to [Table 5.3](#) for explanations of the menu choices.

Table 5.3 User Menu Choices and Explanations

USER					
SubMenu1	SubMenu2	Option	Default	Parameter Description	Comment
RESET		NO	NO	Reset <i>User</i> menu parameters to default setting	
		YES			

USER					
SubMenu1	SubMenu2	Option	Default	Parameter Description	Comment
COM1 (USB)	BUD.RT	1200	9600	Select COM1 baud rate	
		2400			
		4800			
		9600			
		19200			
		38400			
	BT.FMT	8N1	8N1	Select COM1 byte format	(1) 8N1=8 data bits, No parity check bit, 1 stop bit
		7O1			(2) 7O1=7 data bits, 1 Odd parity check bit, 1 stop bit
		7E1			(3) 7E1=7 data bits, 1 Even parity check bit, 1 stop bit
	OUT.MD	none	PRt.cd	Select COM1 output mode	(1) NONE=no communication
		CONT			(2) CONT=continuously output
		PRINT			(3) PRINT=output after [PRINT] key is pressed
		CMD			(4) CMD=output after a request command is received
PRT.CD		(5) PRT.CD= output after [PRINT] key is pressed or request command received			
STABL		(6) STABL=Sends output automatically after scale is stable. Note: use PRINT or CMD to output data, the scale must be stable			
auto-1		** (7) AUTO-1=Weight is automatically transmitted after weight is removed from the scale platform. The last "stable" weight prior to removing the item will be "send", as soon as the display divisions(i.e. 5d). Note: use PRINT or CMD to output data, the scale must be stable.			
**Note: If PRINT, STABL, ST.NLD, LNLd or CMD are used to output data, the scale must be stable.					

USER					
SubMenu1	SubMenu2	Option	Default	Parameter Description	Comment
	LYOUT	MULTi	scp01	Set COM1 content and format	(1) MULTI= the following selected item in OUT1 will be output use defined format
		scp01		Emulates NCI protocol	(2) SCP01= only displayed content and current status will be output, it's compatible with NCI-SCP01
		scp02		Emulates ECR protocol	(3) SCP02= only displayed content and current status will be output. Compatible with ECR-SCP02
		scp03		Emulates Toledo 8213 protocol	(4) SCP03= only displayed content and current status will be output. Compatible with 8213-SCP03
		eh-scp		Emulates Toledo PS60	(5) EH-SCP= command response mode (PS-60)
		IBm		IBM SCP03 protocol	(6) IBM= only displayed content and current status will be output. Compatible with NCI-SCP08

USER					
SubMenu1	SubMenu2	Option	Default	Parameter Description	Comment
OUT1 (USB)	SCL.ID	YES	NO	Enable or disable scale ID number	Prompt is "SCALE ID"
		NO			
	GROSS	YES	yes	Enable or disable gross weight	Prompt is "GROSS"
		NO			
	TARE	YES	yes	Enable or disable tare weight	Prompt is "TARE"
		NO			
	NET	YES	YES	Enable or disable net weight	Prompt is "NET"
		NO			
	COUNT	YES	NO	Enable or disable counts	Prompt is "QUANTITY"
		NO			
	PcWT	YES	NO	Enable or disable piece weight	Prompt is "PIECE WT"
		NO			
	AD.CDE	YES	NO	Enable or disable ADC code	Prompt is "A/D CODE"
		NO			
	BT.VOL	YES	NO	Enable or disable whether to display the battery voltage	Prompt is "VOLTAGE"
		NO			
	STAUS	YES	NO	Enable or disable scale status	Prompt is "STATUS"
		NO			
	B.LINE	NONE	LINE1	How many blank lines after strings output	NONE=no blank line LINE 1/2/3/4=there are 1, 2,3 or 4 blank lines after strings, used for paper feed forward 1/2/3/4 lines.
		LINE1			
LINE2					
LINE3					
LINE4					

USER					
SubMenu1	SubMenu2	Option	Default	Parameter Description	Comment
COM2 (9 Pin)	BUD.RT	1200	9600	Select COM2 baud rate	
		2400			
		4800			
		9600			
		19200			
		38400			
	BT.FMT	8N1	7e1	Select COM2 byte format	(1) 8N1=8 data bits, No parity check bit, 1 stop bit
		7O1			(2) 7O1=7 data bits, 1 Odd parity check bit, 1 stop bit
		7E1			(3) 7E1=7 data bits, 1 Even parity check bit, 1 stop bit
	OUT.MD	none	PRT.CD	Select COM2 output mode	(1) NONE=no communication
		CONT			(2) CONT=continuously output
		PRINT			(3) PRINT=output after PRINT key pressed
		CMD			(4) CMD=output after a request command is received
		PRT.CD			(5) PRT.CD= output after PRINT key pressed or request command received
		STABL			(6) STABL=output after scale is stable; Note: use PRINT or CMD to output data, the scale must be stable
st.nld		** (7) ST.NLD=output after scale has returned to zero range and is stable. (OTHER>NLD.RG)			
nld		** (8) NLD= Output after scale has returned to zero range and does not wait for the scale to be stable. (OTHER>NLD.RG)			
Pr.nLD		(9) PR.NLD= Manual push button print once after scale is stable. Scale has to return to zero range (OTHER>NLD.RG) before another push button print command can be executed.			
**Note: If PRINT, STABL, ST.NLD, LNLND or CMD are used to output data, the scale must be stable.					

USER					
SubMenu1	SubMenu2	Option	Default	Parameter Description	Comment
	LYOUT	MULTi	scp02	Set COM2 content and format	(1) MULTI= the following selected item in OUT2 will be output use defined format
		Scp01		Emulates NCI protocol	(2) SCP01= only displayed content and current status will be output, it's compatible with NCI-SCP01
		scp02		Emulates ECR protocol	(3) SCP02= only displayed content and current status will be output, it's compatible with ECR-SCP02
		scp03		Emulates Toledo 8213 protocol	(4) SCP03= only displayed content and current status will be output, it's compatible with 8213-SCP03
		eh-scp		Emulates Toledo PS60	(5) EH-SCP= command response mode (PS-60)
		Ibm		IBM SCP03 protocol	(6) IBM= only displayed content and current status will be output. Compatible with NCI-SCP08

USER					
SubMenu1	SubMenu2	Option	Default	Parameter Description	Comment
OUT2 (9 Pin)	SCL.ID	YES	NO	Enable or disable scale ID number	Prompt is "SCALE ID"
		NO			
	GROSS	YES	yes	Enable or disable gross weight	Prompt is "GROSS"
		NO			
	TARE	YES	yes	Enable or disable tare weight	Prompt is "TARE"
		NO			
	NET	YES	YES	Enable or disable net weight	Prompt is "NET"
		NO			
	COUNT	YES	NO	Enable or disable counts	Prompt is "QUANTITY"
		NO			
	PcWT	YES	NO	Enable or disable piece weight	Prompt is "PIECE WT"
		NO			
	AD.CDE	YES	NO	Enable or disable ADC code	Prompt is "A/D CODE"
		NO			
	BT.VOL	YES	NO	Enable or disable whether to display the battery voltage	Prompt is "VOLTAGE"
		NO			
	STAUS	YES	NO	Enable or disable scale status	Prompt is "STATUS"
		NO			
	B.LINE	NONE	LINE1	How many blank lines after strings output	NONE=no blank line LINE 1/2/3/4=there are 1, 2,3 or 4 blank lines after strings, used for paper feed forward 1/2/3/4 lines.
		LINE1			
LINE2					
LINE3					
LINE4					

USER					
SubMenu1	SubMenu2	Option	Default	Parameter Description	Comment
BEEP	KEY	YES	YES	Enable or disable beep after a key is pressed.	
		NO			
	COMPR	NONE	IN.LMT		(1) NONE = no beep
		L.LOW			(2) L.Low = beep when lower than low limitation;
		IN.LMT			(3) IN.LMT = beep when in range of low and high limitation
		O.HIGH			(4) O.HIGH = beep when over high limitation
		OUT.LMT			(5) OUT.LMT = beep when lower than low limitation or higher than high limitation

USER					
SubMenu1	SubMenu2	Option	Default	Parameter Description	Comment
HOLD	AD.H.SP	YES	NO	Enable or disable use of the high speed A/D converter after entering the HOLD mode	
		NO			
	HLD.MD	NONE	auto	Hold mode	(1) NONE= off
		PS.PEK			(2) PS.PEK=Positive Peak number Hold mode. Scale will display and refresh the positive peak value from last zero setting.
		NG.PEK			(3) NG.PEK=Negative PEAK number Hold mode. It is similar to PS.PEK, but a negative number is used.
		TOGGLE			(4) TOGGLE=Press [HOLD] key to enter HOLD mode. Stores the display value. Will stay on the display for the duration of time set at HLD.TM.
		AVERG			(5) AVERG= Average HOLD mode. Time it looks at the weight before updating the display. Set by AVG.TM. Weight or vibration must fall within window of HLD.RG also.
		AUTO			(6) AUTO=Auto hold mode. It is similar to AVERAG mode, but will allow more weight to be added.
	AVG.TM	1-60	3	Average data time for HOLD mode	1-60 seconds
	STB.TM	3XAVG.TIM-255	3X AVG.TIM	Wait time for the scale to be stable in HOLD mode	Window which has to be 3 times larger than AVG.TM
	HLD.TM	0-65535	0	Data HOLD time	0=data will be frozen until HOLD key pressed. 1-65535=data frozen time is 1-65535s, after the time elapses, scale will exit HOLD mode.
	HLD.RG	0-255	5	Hold range	Window of vibration for Auto to work. 0=any data can be averaged 1-255= only the data which vibration is in 1-255d can be averaged and held.
	hd.key	hold	hold	HOLD/PRINT key	(1) HOLD= only HOLD key
		print			(2) PRINT= only PRINT key
hld.pr		(3) HLD.PR= HOLD and PRINT key			

USER					
SubMenu1	SubMenu2	Option	Default	Parameter Description	Comment
OTHER	NLD.RG	1-255	10	No hold range	Load must return to zero in divisions to perform a print when in AUTO. 1-255=the range of weight is 1-255d. When current weight is less than this value, the scale can be regarded as empty, or the load on scale is removed. It must be bigger than (CONFIG.MOTON).
	CMD.SR	NONE	COM1.2	Command source Turns COM1 / COM2 on/off	(1) NONE=no any command will be executed
		COM.1			(2) COM.1= command from COM1 will be executed
		COM.2			(3) COM.2= command from COM2 will be executed
		COM1.2			(4) COM.1.2= command from COM1 or COM2 will be executed
	Legacy	0-2	1	Status bit setting	0=no change to output string. Can send 3 or 4 status bits
					1=all data sent out has 2 status bits = bit 6. Character 2 must be set to 0
					2=all data sent out has 3 status bits and 7 weight characters.
	A.OFF.T	0-255	0	Auto off time	0=not auto power off 1-255=auto power off after 1-255 minutes. In this period, no operation or no weight change
	LCD.BL	0-255	30	LCD backlight set	(1) 0=always off (2) 1=always on (3) 2=press down ZERO+UNIT together more than 3s to turn on or turn off (4) 3-255=auto on when key operation or weight changing. Auto off after 3-255s elapsed.
TA.key	yes	yes	Tare key enable	Yes= tare key is enabled	
	no			No= tare key is disabled	
phd.rg	0-8	0	Photo eye TARE sensitivity	(1) 0= remote TARE key disabled (2) 1-8 = sensitivity level 1= close distance - 8= long distance	
SCL.ID	000000-999999	123456	Scale ID number: 000000-999999		

5.3.3 CAL Menu

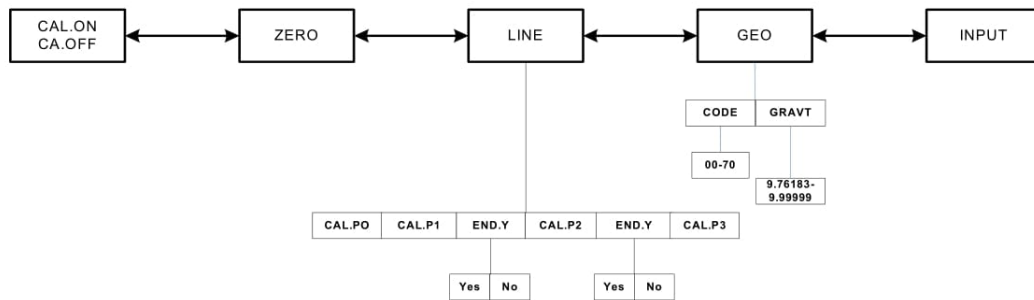

Figure 5.3 CAL Menu Chart

The figure above is an illustration of the available menus with the CAL menu and the choices within those menus. Refer to [Table 5.4](#) for explanations of the menu choices.

Table 5.4 CAL Menu Choices and Explanations

CAL				
Submenu1	Submenu2	Option	Parameter Description	Comment
CAL.ON CA.OFF			Seal switch position	The display will show whether the seal switch is in the ON or Off position. This parameter can't be changed within the software.
ZERO			Zero point calibration	Only do zero point calibration, then go to CAL.END to end (only need where a zero shift has occurred).

CAL					
Submenu1	Submenu2	Option	Parameter Description	Comment	
LINE	CAL.P0		Line calibration point0	Do zero point calibration. This point can't be omitted.	
	CAL.P1		Line calibration point1	First weight point calibration. This point can't be omitted and standard weight must be over 10%FS.	
	END.Y	YES	End calibration?		YES=go to CAL.END to end NO=go to do next point calibration
		NO			
	CAL.P2		Line calibration point2	Second weight point calibration. Standard weight must be over 10%FS and be larger than it in CAL.P1. This point can be omitted.	
	END.Y	YES	End calibration?		YES=go to CAL.END to end NO=go to do next point calibration
		NO			
CAL.P3		Line calibration point3:	Third weight point calibration. Standard weight must be over 10%FS and be larger than it in CAL.P2, this point can be omitted.		
geo	code	00-70	Select geographical position	Code 00-70	
	gravt	9.76183-9.99999	Input gravity of user location		
input			Input or view calibration parameter values	Only used to copy calibration parameters from one scale to a new scale.	

5.3.4 MISC Menu

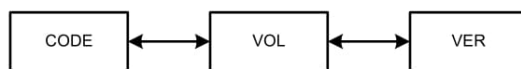

Figure 5.4 MISC Menu Chart

The figure above is an illustration of the available menus with the MISC menu. There are no programming choices within this menu. Refer to [Table 5.5](#) for explanations of the menu choices.

Table 5.5 MISC Menu Choices and Explanations

MISC	
Submenu1	Remark
CODE	Display A/D counts = approximately 100,000 counts per mV
VOL	Display voltage; calibrate voltage; set full charged voltage and low battery voltage
VER	Display firmware version

5.3.5 TEST Menu

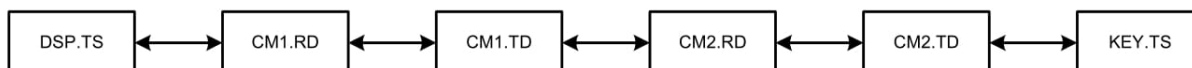

Figure 5.5 TEST Menu Chart

The figure above is an illustration of the available menus with the TEST menu. There are no programming choices within this menu. Refer to [Table 5.6](#) for explanations of the menu choices.

Table 5.6 TEST Menu Choices and Explanations

TEST	
Submenu1	Remark
dsp.ts	Test LCD
cm1.rd	Test COM1 receiving
cm1.td	Test COM1 transmitting
cm2.rd	Test COM2 receiving
cm2.td	Test COM2 transmitting
KEY.ts	Test keys and buzzer

5.4 Exit the Setup Menu

1. Power off the indicator by pressing and holding the **[ON/OFF]** key.
2. Turn the indicator back on by pressing the **[ON/OFF]** key. The display will go through a digit check, then settle into the normal operating mode. All front panel keys will now return to their normal mode of operation.

6 Calibration

The configuration/calibration button must be pushed in order to calibrate the scale. Refer to Chapter 8 for details on push button location.



NOTE: More than 10% of the full scale weight is needed for calibration.



NOTE: Press the [ON/OFF] key to return to the last sub-menu.

6.1 Enter the Calibration Mode

1. Access the setup mode by pressing the [HOLD]+[ON/OFF] key for 3 seconds.
2. Use the [PRINT] key to select the CAL menu.
3. Press the [TARE] key to enter the calibration mode.
- 3a. After entering this mode, the number of calibrations will be shown first. This number will be increment one digit after every calibration and calibration data saved. This counter can't be modified or erased. It counts from 0000 to 9999, when 9999 is reached, the counter starts over at 0000.
4. After the counter number was displayed, it will show "Ca.OFF" or "CAL.ON" which depends on whether the sealed calibration switch is OFF or ON. **If the switch is OFF, the following steps can be done, but the result will not be saved.**
5. Press the [TARE] key to go to next step.

6.1.1 Zero Point

1. When ZERO is displayed, press the [UNIT] key to select Zero Point calibration.
2. Once ZERO is selected, remove all weight on the scale.
3. Press [TARE] to confirm.
4. The ZERO will flash while capturing the zero point. After getting reasonable data, it automatically saves the change and exits to the weigh mode.

6.1.2 Linearity

The scale linearity can be calibrated with a zero reference and a full scale reference or multiple linearity weight values. The linearity calibration is determined by the settings in the CAL-LINE parameter.

1. When LINE is selected, press the **[TARE]** key to enter linearity calibration.
2. CAL.P0 will be displayed with a zero value. Remove all weight on the scale and then press the **[TARE]** key to confirm zero point calibration. The zero weight will flash while capturing the zero point. After getting the reasonable zero-point data, the zero weight will become steady.
3. The first default standard weight is displayed after CAL.P1 being shown. Put the corresponding weight (more than 10%FS weight) onto scale. The default standard weight is 100%FS.
4. Use the **[HOLD]** and **[UNIT]** keys to input the value of the loaded weight.
5. Press the **[TARE]** key to confirm.
- 5a. The indicator will flash the input standard weight. When the weight becomes steady the indicator will automatically go to next step. If this point can't be calibrated correctly CAL.Er will be displayed. It is possible the weight load onto scale is too small or the input data is incorrect. Repeat the previous steps.
6. When End.y is shown and the y is flashing, it is waiting to exit calibration or go on next calibration point. Use the **[UNIT]** key to select yes or no.
7. Press the **[TARE]** key to confirm.
- 7a. If yes is selected, the calibration will be saved and exit to the weigh mode.
- 7b. If no is selected, it will go to next step.
8. When 100% of the full scale weight is displayed after CAL.P2 is shown, it will be calibrated on standard weight for the second point.
9. Use the **[HOLD]** and **[UNIT]** keys to input the value of the loaded weight (more than 10% FS weight, and larger than the weight used on CAL.P1) onto scale.
10. When End.y is shown and the y is flashing, it is waiting to exit calibration or go on next calibration point. Use the **[UNIT]** key to select yes or no.
11. Press the **[TARE]** key to confirm.
12. When 100% of the full scale weight is displayed after CAL.P3 is shown, it will be calibrated on standard weight for the third point.
13. Use the **[HOLD]** and **[UNIT]** keys to input the value of the loaded weight (more than 10% FS weight, and larger than the weight used on CAL.P2) onto scale.
14. When End.y is shown and the y is flashing, it is waiting to exit calibration or go on next calibration point. Use the **[UNIT]** key to select yes or no.
15. Press the **[TARE]** key to confirm.
16. When calibration is complete CA.End will be displayed. The indicator will restart and go back to the weigh mode.

6.2 Geographical Adjustment

1. When GEO is selected, press the **[TARE]** key to enter Geographical Adjustment.
2. When CODE is displayed, press the **[UNIT]** key to select geographical position code or input user local gravity value directly.
3. When CODE is selected, choose the position code of the scale being used (00-70) according to the elevation and latitude from [Table 6.1](#) by using the **[HOLD]** and **[UNIT]** keys.
4. Press **[TARE]** key to confirm.



CAUTION! Only an authorized manufacturer representative or certified verification personnel may make these changes. Changing the Geographical setting alters the calibration values!

Table 6.1 Location Code For Elevation and Latitude

Elevation (km)	0	0.2	0.4	0.6	0.8	1	1.2	1.4	1.6	1.8	2	2.2	2.4	2.6	2.8	3	3.2	3.4	3.6	3.8	4	4.2	4.4	4.6	4.8	5	5.2	5.4	5.6	5.8	6		
Latitude																																	
0	19	18	17	17	16	15	14	14	14	13	12	12	11	11	10	9	9	8	8	7	6	6	5	4	4	4	3	2	1	1	0		
3	19	18	17	17	16	15	14	14	14	13	12	12	11	11	10	9	9	8	8	7	6	6	5	4	4	4	3	2	1	1	0		
6	19	18	18	17	17	16	15	14	14	14	13	12	12	11	10	10	9	9	8	7	7	6	6	5	4	4	4	3	2	1	1		
9	20	19	19	18	17	16	15	15	14	14	13	12	12	11	11	10	9	9	8	7	7	6	6	5	4	4	3	2	2	1			
12	21	20	20	19	18	17	16	16	15	14	13	12	13	13	12	11	10	10	9	8	8	7	7	6	5	5	4	3	3	2			
15	22	21	21	20	20	19	18	17	16	16	15	14	13	13	12	11	10	10	9	8	7	7	6	5	4	3	3	2	1				
18	23	23	22	22	21	20	19	19	18	17	17	16	15	14	13	12	11	10	9	8	7	7	6	5	4	3	2	1	1	0			
21	25	25	24	23	23	22	21	21	20	20	19	18	17	16	15	14	13	12	11	10	9	8	7	6	5	4	3	2	1	0			
24	27	26	26	25	24	23	23	23	22	21	20	20	19	18	17	16	15	14	13	12	11	10	10	9	8	7	6	5	4	3	2		
27	29	29	28	27	27	26	25	24	24	24	23	22	22	21	20	19	18	17	16	15	14	13	13	12	11	10	9	8	7	6	5		
30	31	31	30	30	29	28	27	26	26	25	24	23	22	21	20	19	18	17	16	15	14	13	12	11	10	9	8	7	6	5	4		
33	34	33	33	32	31	30	30	29	28	28	27	26	25	24	23	22	21	20	19	18	17	16	15	14	13	12	11	10	9	8	7		
36	36	36	35	34	34	33	32	31	31	30	29	28	27	26	25	24	23	22	21	20	19	18	17	16	15	14	13	12	11	10	9		
39	39	38	38	37	36	35	35	34	33	33	32	31	30	29	28	27	26	25	24	23	22	21	20	19	18	17	16	15	14	13	12		
42	42	41	40	40	39	38	37	36	35	34	33	32	31	30	29	28	27	26	25	24	23	22	21	20	19	18	17	16	15	14	13		
45	44	44	43	42	42	41	40	39	38	37	36	35	34	33	32	31	30	29	28	27	26	25	24	23	22	21	20	19	18	17	16		
48	47	46	46	45	44	43	42	41	40	39	38	37	36	35	34	33	32	31	30	29	28	27	26	25	24	23	22	21	20	19	18		
51	50	49	48	47	47	46	45	44	43	42	41	40	39	38	37	36	35	34	33	32	31	30	29	28	27	26	25	24	23	22	21		
54	52	52	51	50	49	48	47	46	45	44	43	42	41	40	39	38	37	36	35	34	33	32	31	30	29	28	27	26	25	24	23	22	
57	55	54	54	53	52	51	50	49	48	47	46	45	44	43	42	41	40	39	38	37	36	35	34	33	32	31	30	29	28	27	26		
60	57	57	56	55	55	54	53	52	51	50	49	48	47	46	45	44	43	42	41	40	39	38	37	36	35	34	33	32	31	30	29		
63	60	59	58	58	57	56	55	54	53	52	51	50	49	48	47	46	45	44	43	42	41	40	39	38	37	36	35	34	33	32	31		
66	62	61	60	60	59	58	57	56	55	54	53	52	51	50	49	48	47	46	45	44	43	42	41	40	39	38	37	36	35	34	33	32	
69	64	63	62	62	61	60	59	58	57	56	55	54	53	52	51	50	49	48	47	46	45	44	43	42	41	40	39	38	37	36	35	34	
72	65	65	64	63	63	62	61	60	59	58	57	56	55	54	53	52	51	50	49	48	47	46	45	44	43	42	41	40	39	38	37	36	
75	67	66	66	65	64	64	63	62	61	60	59	58	57	56	55	54	53	52	51	50	49	48	47	46	45	44	43	42	41	40	39	38	
78	68	67	67	66	65	64	63	62	61	60	59	58	57	56	55	54	53	52	51	50	49	48	47	46	45	44	43	42	41	40	39	38	
81	69	68	68	67	66	65	64	63	62	61	60	59	58	57	56	55	54	53	52	51	50	49	48	47	46	45	44	43	42	41	40	39	
84	70	69	68	68	67	66	65	64	63	62	61	60	59	58	57	56	55	54	53	52	51	50	49	48	47	46	45	44	43	42	41	40	
87	70	69	68	68	67	66	65	64	63	62	61	60	59	58	57	56	55	54	53	52	51	50	49	48	47	46	45	44	43	42	41	40	
90	70	69	68	68	67	66	65	64	63	62	61	60	59	58	57	56	55	54	53	52	51	50	49	48	47	46	45	44	43	42	41	40	

6.3 Gravity Value

1. When GRAVT is selected, press the **[HOLD]** and **[UNIT]** keys to input the gravity value of the position that scale is used (9.76183-9.99999).
2. Press the **[TARE]** key to confirm.



NOTE: Only an authorized manufacture representative or certified verification personnel may make these changes.

6.4 Input or View Calibration

1. When INPUT is selected, press the **[TARE]** key to enter Input calibration parameter values that were previously received or view current calibration parameter values.

All parameters regarding calibration are divided to 12 pages and are displayed on LCD by "nn:xxxx" format ("nn" is a decimal number of page, "xxxx" is an hexadecimal value of parameter. (e.g. 02:85E2).

01-02 pages: zero code

03-04 pages: standard weight of CAL.P1

05-06 pages: codes of CAL.P1

07-08 pages: standard weight of CAL.P2

09-10 pages: codes of CAL.P2

11-12 pages: full capacity net code

2. When no digits are blinking on the display, this means calibration parameters value are being viewed. Use the **[HOLD]** key to view the next page.
3. When parameter values are being viewed, press the **[HOLD]** key for more than 3 seconds to modify.
4. When first digit is blinking, this means the value is being modified. Press the **[HOLD]** key to make next digit flash (if current flashing position is the last one the next page value will be shown).
5. Press the **[HOLD]** and **[UNIT]** keys to input the number.
6. Press the **[TARE]** key to confirm.
7. After the indicator gets all needed data, it will calculate and store all calibration parameters into EEPROM or after finishing calibration, it will display CAL.nd.
8. The scale will re-start and go back to original mode.

6.5 Weight Fine-tune

With this function, the user can adjust displayed weight a little without the need of standard weight. But please note:

- The scale must have been calibrated previously
 - The range of adjustment is "(current displayed weight) x (0.9-1.1)". This means the range is about $\pm 10\%$
 - The CONFIG-REGUL=NONE and CONFIG-FUNC-WT.ADJ=YES must be set.
1. To enter this mode, turn on indicator. After the indicator displays a 0 weight, place weight onto scale. The indicator will display the weight.
 2. Press down **[TARE]** and **[ZERO]** at same time until the first digit flashes, this means indicator has entered into "weight fine-tune" mode.
 3. Use the arrow keys to input correct weight.
 4. Press the **[TARE]** key to confirm. The active correct weight will be displayed. The displayed weight will be adjusted by this ratio (130.0/1234.5). The ratio will be active until the next modification.
 5. Recalibrate the scale or use the Weight Fine Tune method to readjust the ration.

6.6 Display ADC Output Code

In this mode, you can examine the stability of weighing system and increment the ADC output code corresponding to the loaded weight. Please note the following:

- The increment of ADC code for full scale weight must be larger or equal to 10 times of selected display division. Otherwise, the calibration cannot be properly completed.
 - e.g. The display division is 0.1kg. Load 100kg standard weight on the platform, the increment of ADC code should be at least more than $10 \times 100\text{kg} / 0.1\text{kg} = 10 \times 1000 = 10000$. In this case, the scale can be calibrated. Otherwise, a smaller division needs to be chosen.
 - The variation of the ADC code should be small. Otherwise, the calibration cannot be properly completed.
1. From the weigh mode press the **[HOLD] + [ON/OFF]** key until CONFIG is shown.
 2. Use the **[UNIT]** and **[TARE]** keys to go to MISC - Code.
 3. Press the **[TARE]** key to enter this mode and display the ADC output raw code.
 4. Press the **[TARE]** key to set the current code as a reference zero and then display net code
 5. Press **[TARE]** again to clear this reference and display gross code.
 6. In this mode, press the **[UNIT]** key to select displaying code that has been filtered by no-filter, filter1 and filter2.
 7. Press the **[ON/OFF]** key to exit this mode.

7 Serial Communication

7.1 Communication Settings

1. Power on the indicator by pressing and holding the **[ON/OFF]** key. The display will go through a display test then go into regular weigh mode.
2. Press the **[HOLD] + [ON/OFF]** key for 3 seconds. The indicator shows **confg** to indicate that you are in Setup Menu mode.
3. Press the **[UNIT]** key until the indicator display shows **user**.
4. Press the **[TARE]** key and the indicator display shows **reset**.
5. Press the **[UNIT]** key until you see the com port you are using for your software; **com1** (USB port) or **com2** (serial port)
6. Press the **[TARE]** key to select the desired com port.
7. The indicator's display shows **bud.rt**. Press the **[TARE]** key go into the baud rate setting and confirm it is appropriate baud rate for your software. To toggle to another baud rate setting, press the **[UNIT]** key until the one is displayed. (i.e. 1200, 2400, 4800, 9600, 19200, 38400)
8. Press the **[TARE]** key and the display shows **bud.rt**. Press the **[UNIT]** key and the display shows **bt.fmt**. Press the **[TARE]** key to go into the setting and confirm it is the appropriate bit format for your software. To select another bit format setting, press the **[UNIT]** key until the desired selection is displayed. (i.e. 8n1, 7E1, 7O1)
9. Press the **[TARE]** key and the display shows **bt.fmt**. Press the **[UNIT]** key until the display shows **lyout**.
10. Press the **[TARE]** key to go into your selection and press the **[UNIT]** key until the display shows correct protocol needed for your software. *Most common as follows **sep01** = NCI protocol, **sep02** = ECR protocol, **sep03** = Toledo 8213 or **ibm** = IBM protocol.
11. Press the **[TARE]** key and **lyout** will be displayed.
12. Press the **[ZERO]** key to display the com port that you were changing.
13. Press the **[UNIT]** key until the display shows **other**.
14. Press the **[TARE]** key until the display shows **nld.rg**.
15. Press the **[UNIT]** key until **legacy** is displayed.
16. Press the **[TARE]** key and a number will be displayed.
17. Press the **[UNIT]** key until a **2** is displayed.
18. Press the **[TARE]** key and **legacy** will be displayed.
19. Press and release the **[ZERO/ON/OFF]** key until you are all the way out of the Setup Menu mode and into the Normal Weigh mode.
20. Test scale with software. If scale fails communication, contact Brecknell Tech Support at 800-242-2807 for further testing.

7.2 Com Port 1

COM1 is a USB port used as a virtual RS-232 port. Communication wires come from the USB connector and TXD0, RXD0 and GND.

7.3 Com Port 2

COM2 is a RS-232 bi-directional port. Communication wires are connected to the RS-232 connector using TXD1, RXD1 and GND. Refer to [page 19](#) for connection details.

7.4 Protocol

The baud rate and byte format is set by USER-COM-BUD.RT and USER-COM-BT.FMT.

Responses to serial commands will be immediate or within one weight measure cycle of the scale. One second should be adequate for use as a time-out value by remote (controlling) device.

7.5 Transaction String

The length of each item in a transition string:

- Reading data --- 6 bytes
- Data polarity ----1 byte: "-" for negative, and followed the first digit; " " for positive.
- Decimal point ---1 byte: "."
- Measure unit ----1-5 bytes:" lb", " kg", "lb:oz", "pcs", "%". Units are always lower case, left aligned
- Current status-- 4 bytes
 - If the weight is over capacity, the scale will return eight "^" characters (the field of polarity, decimal point, weight data is filled by "^").
 - If the weight is under capacity, it will return eight "_" characters (the field of polarity, decimal point, and weight data is filled by "_").
 - If the zero point is error, it will return eight "-" characters (the field of polarity, decimal point, and weight data is filled by "-").

Useless leading 0 before digits is suppressed. Reading weight is right aligned.

Table 7.1 Symbols Used

<LF>	Line Feed character (hex 0AH)
<CR>	Carriage Return character (hex 0DH)
<ETX>	End of Text character (hex 03H)
<SP>	Space (hex 20H)
H ₁ H ₂ H ₃ H ₄	Four current status bytes
<P>	Polarity character: "-" or " "

W ₁ ---W ₆	Reading data, 1-6 bytes (six digits)
<DP>	Decimal point
U ₁ U ₂ U ₃ U ₄ U ₅	Measure units, kg, lb, lb:oz, % or pcs; 2-5 bytes
<Add>	Address of scale; 2 bytes (00-99)
<Prompt>	Prompt characters of output content; max. 11bytes

Table 7.2 Bit Definition of H₁H₂H₃ H₄

Bit	Byte 1 (H ₁)	Byte 2 (H ₂)	Byte 3 (H ₃)	Byte 4 (H ₄)
0	0 = stable	0 = not under capacity	00 = compare disable 01 = lower limit 10 = ok 11= upper limit	00 = normal weighing 01 = count weighing 10 = percent weighing 11 = other mode
	1 = not stable	1 = under capacity		
1	0 = not at zero point	0 = not over capacity		
	1 = at zero point	1 = over capacity		
2	0 = RAM ok	0 = ROM ok	0 = gross weight	0 = not in HOLD
	1 = RAM error	1 = ROM error	1 = net weight	1 = in HOLD
3	0 = eeprom OK	0 = calibration ok	0 = initial zero ok	0 = battery ok
	1 = eeprom error	1 =calibration error	1 = initial zero error	1 = low battery
4	always 1	always 1	always 1	always 1
5	always 1	always 1	always 1	always 1
6	always 0	always 1	always 1	always 0
7	parity	Parity	parity	Parity

7.6 Commands and Response

7.6.1 Parameter NCI-SCP01

Set the USER-COM-LYOUT parameter to SCP01.

Command: W<CR> (57h 0dh), request current reading

Response
<LF> ^^^^^^^^ U ₁ U ₂ U ₃ U ₄ U ₅ <CR><LF> H ₁ H ₂ H ₃ H ₄ <CR><ETX>---over capacity
<LF> _ _ _ _ _ U ₁ U ₂ U ₃ U ₄ U ₅ <CR><LF> H ₁ H ₂ H ₃ H ₄ <CR><ETX>---under capacity
<LF> - - - - - U ₁ U ₂ U ₃ U ₄ U ₅ <CR><LF> H ₁ H ₂ H ₃ H ₄ <CR><ETX>---zero-point error
Note: U ₁ U ₂ U ₃ U ₄ U ₅ is 1,2,3 or 5 bytes according to current unit: kg, lb, pcs, g, oz, lb:oz
<LF><P>W ₁ W ₂ W ₃ W ₄ W ₅ <DP>W ₆ U ₁ U ₂ U ₃ U ₄ U ₅ <CR><LF> H ₁ H ₂ H ₃ H ₄ <CR><ETX>---normal data
Note: (1) The decimal point position is determined by CONFIG-PRIM.D (2) If current unit is "lb:oz", the format will be similar with following:
<LF><P>W ₁ W ₂ W ₃ lb <SP>W ₄ W ₅ <DP>W ₆ oz <CR><LF> H ₁ H ₂ H ₃ H ₄ <CR><ETX>

Command: S<CR> (53h 0dh), request current status

Response
<LF> H ₁ H ₂ H ₃ H ₄ <CR><ETX>

Command: Z<CR> (5ah 0dh)

Response
Zero function is activated (simulate ZERO key) and it returns to current scale status.
<LF> H ₁ H ₂ H ₃ H ₄ <CR><ETX>

If ZERO function cannot be activated, it will return to current scale status.

Command: T<CR> (54h 0dh)

Response
TARE function is activated (simulate TARE key), and then returns scale status.
<LF> H ₁ H ₂ H ₃ H ₄ <CR><ETX>

If TARE function cannot be activated, it will return to current scale status.

Command: U<CR> (55h 0dh)

Response
Changes units of measure (simulate UNIT key) and return scale status with new units. The new measure unit should be allowed to use
<LF> U ₁ U ₂ U ₃ U ₄ U ₅ <CR><LF> H ₁ H ₂ H ₃ H ₄ <CR><ETX>

Command: L<CR> (4ch 0dh)

Response
If Hold function can be activated, it will enable/disable hold function (simulate HOLD key) and returns scale status.
<LF> H ₁ H ₂ H ₃ H ₄ <CR><ETX>

Command: X<CR> (58h 0dh)

Response
Power off the scale. Same as pressing the ON/OFF key to turn off the scale.

Command: all others

Response
Unrecognized command
<LF>? <CR><ETX>

Table 7.3 Summary of Command and Response:

Command		Response
ASCII	HEX	
W<CR>	57 0d	Read scale weight: <LF>^^^^^^U ₁ U ₂ U ₃ U ₄ U ₅ <CR><LF> H ₁ H ₂ H ₃ H ₄ <CR><ETX>---over capacity <LF>_____U ₁ U ₂ U ₃ U ₄ U ₅ <CR><LF> H ₁ H ₂ H ₃ H ₄ <CR><ETX>---under capacity <LF>----- U ₁ U ₂ U ₃ U ₄ U ₅ <CR><LF> H ₁ H ₂ H ₃ H ₄ <CR><ETX>---zero-point error <LF><P>W ₁ W ₂ W ₃ W ₄ W ₅ <DP>W ₆ U ₁ U ₂ U ₃ U ₄ U ₅ <CR><LF>H ₁ H ₂ H ₃ H ₄ <CR><ETX>---normal data
S<CR>	53 0d	<LF>H ₁ H ₂ H ₃ H ₄ <CR><ETX>; read scale status
Z<CR>	5a 0d	<LF>H ₁ H ₂ H ₃ H ₄ <CR><ETX>; simulate ZERO key
T<CR>	54 0d	<LF>H ₁ H ₂ H ₃ H ₄ <CR><ETX>; simulate TARE key
U<CR>	55 0d	<LF> U ₁ U ₂ U ₃ U ₄ U ₅ <CR><LF>H ₁ H ₂ H ₃ H ₄ <CR><ETX>; simulate UNIT key
L<CR>	4c 0d	<LF>H ₁ H ₂ H ₃ H ₄ <CR><ETX>; simulate HOLD key
X<CR>	58 0d	power off the scale, simulate OFF key
others		<LF>? <CR><ETX>

7.6.2 Parameter ECR-SCP02

Set the USER-COM-LYOUT parameter to SCP02.

Command: W<CR> (57h 0dh), request current reading

Response
<LF>^^^^^^U ₁ U ₂ U ₃ U ₄ U ₅ <CR><LF> S H ₁ H ₂ H ₃ H ₄ <CR><ETX>---over capacity
<LF> _ _ _ _ _ U ₁ U ₂ U ₃ U ₄ U ₅ <CR><LF> S H ₁ H ₂ H ₃ H ₄ <CR><ETX>---under capacity
<LF> - - - - - U ₁ U ₂ U ₃ U ₄ U ₅ <CR><LF> S H ₁ H ₂ H ₃ H ₄ <CR><ETX>---zero-point error
Note: U ₁ U ₂ U ₃ U ₄ U ₅ is 1,2,3 or 5 bytes according to current unit: kg, lb, pcs, g, oz, lb:oz
<LF><<P>W ₁ W ₂ W ₃ W ₄ W ₅ <DP>W ₆ U ₁ U ₂ U ₃ U ₄ U ₅ <CR><LF> S H ₁ H ₂ H ₃ H ₄ <CR><ETX>---normal data
Note: (1) The decimal point position is determined by CONFIG-PRIM.D (2) If current unit is "lb:oz", the format will be similar with following:
<LF><<P>W ₁ W ₂ W ₃ lb<SP>W ₄ W ₅ <DP>W ₆ oz<CR><LF> S H ₁ H ₂ H ₃ H ₄ <CR><ETX>

Command: S<CR> (53h 0dh), request current status

Response
<LF> S H ₁ H ₂ H ₃ H ₄ <CR><ETX>

Command: Z<CR> (5ah 0dh)

Response
Zero function is activated (simulate ZERO key) and it returns to current scale status.
<LF> S H ₁ H ₂ H ₃ H ₄ <CR><ETX>

If ZERO function cannot be activated, it will return to current scale status.

Command: U<CR> (55h 0dh)

Response
Changes units of measure (simulate UNIT key) and return scale status with new units. The new measure unit should be allowed to use
<LF> U ₁ U ₂ U ₃ U ₄ U ₅ <CR><LF> S H ₁ H ₂ H ₃ H ₄ <CR><ETX>

Command: u<CR> (75h 0dh)

Response
Returns current units-of-measure as a single numeric character.
<LF>x<CR><ETX>
x = 1 = grams 2 = kilograms 3 = ounces 4 = pounds 5 = pounds - ounces

Command: A<CR> (41h 0dh)

Response
Returns scale OPOS capabilities as a string of five flag characters.
<LF>vwxyz<CR><ETX>
v = T - scale has a weight display (CapDisplay) v = F - scale does not have a weight display
w = T -scale has a text display (CapDisplayText) w = F -scale does not have a text display
x = T -scale can calculate unit price (CapPriceCalculating) x = F -scale cannot calculate unit price
y = T -scale allows setting tare value (CapTareWeight) y = F -scale does not allow setting tare value
z = T -scale may be zeroed (CapZeroScale) z = F -scale cannot be zeroed

Command: m<CR> (6dh 0dh)

Response
Returns current maximum weight supported by the scale as a string value, without decimal point and in the currently enabled unit of measure.
<LF>XX<CR><ETX>

Command: <ENQ><CR> (05h 0dh)

Response
Depends on the scale and protocol.
<LF>OPOS<CR><ETX> OPOS - enabled scale

Command: all others

Response
Unrecognized command
<LF>? <CR><ETX>

Table 7.4 Summary of Command and Response:

Command		Response
ASCII	HEX	
W<CR>	57 0d	Read scale weight: <LF>^^^^^^U ₁ U ₂ U ₃ U ₄ U ₅ <CR><LF>S H ₁ H ₂ H ₃ H ₄ <CR><ETX>---over capacity <LF>_____U ₁ U ₂ U ₃ U ₄ U ₅ <CR><LF>S H ₁ H ₂ H ₃ H ₄ <CR><ETX>---under capacity <LF>----- U ₁ U ₂ U ₃ U ₄ U ₅ <CR><LF> S H ₁ H ₂ H ₃ H ₄ <CR><ETX>---zero-point error <LF><P>W ₁ W ₂ W ₃ W ₄ W ₅ <DP>W ₆ U ₁ U ₂ U ₃ U ₄ U ₅ <CR><LF> S H ₁ H ₂ H ₃ H ₄ <CR><ETX>---normal data
S<CR>	53 0d	<LF> S H ₁ H ₂ H ₃ H ₄ <CR><ETX>; read scale status
Z<CR>	5a 0d	<LF> S H ₁ H ₂ H ₃ H ₄ <CR><ETX>; simulate ZERO key
U<CR>	55 0d	<LF>U ₁ U ₂ U ₃ U ₄ U ₅ <CR><LF> S H ₁ H ₂ H ₃ H ₄ <CR><ETX>; simulate UNIT key
u<CR>	75 0d	<LF> x<CR><ETX>
A<CR>	41 0d	<LF>vwxyz<CR><ETX>
m<CR>	6d 0d	<LF>xx<CR><ETX>
<ENQ><CR>	05 0d	<LF>OPOS<CR><ETX>
L<CR>	4c 0d	<LF>H ₁ H ₂ H ₃ H ₄ <CR><ETX>; simulate HOLD key
X<CR>	58 0d	Power off the scale, simulate OFF key
others		<LF>? <CR><ETX>

7.6.3 Parameter 8213-SCP03

Set the USER-COM-LYOUT parameter to SCP03.

Command: W (57h), request current reading

Response
<STX>W ₁ W ₂ <dp>W ₃ W ₄ W ₅ <CR>---normal data
Note: (1) The decimal point position is determined by CONFIG-PRIM.D (2) If current unit is "lb:oz", the format will be similar with following:
<STX>W ₁ W ₂ W ₃ lbW ₄ W ₅ <dp>W ₆ oz<CR>

Command: Z (5ah)

Response
Zero function is activated (simulate ZERO key) and it returns to current scale status.
<STX>?[status]<CR>

If ZERO function cannot be activated, it will return to current scale status.

Table 7.5 Status Bits

Bit	Status
0	0 = not in motion
	1 = in motion
1	0 = not over capacity
	1 = over capacity
2	0 = not under zero (positive polarity)
	1 = under zero (negative polarity)
3	0 = inside zero capture range
	1 = outside zero capture range
4	0 = not center of zero
	1 = center of zero
5	always 1
6	always 1
7	parity

Command: H (48h)

Response
Send high resolution weight dat (x10)
<STX>W ₁ W ₂ <dp>W ₃ W ₄ W ₅ <CR>---normal data
Note: (1) The decimal point position is determined by CONFIG-PRIM.D (2) If current unit is "lb:oz", the format will be similar with following:
<STX>W ₁ W ₂ W ₃ lbW ₄ W ₅ W ₆ <dp>W ₇ oz<CR>

Command: A (41h)

Response
Scale initiates a test of RAM, ROM and NOVRAM. Places the result into confidence test status byte for future interrogation by the host. It also returns acknowledgement.
<STX>?<CR>

Command: B (42h)

Response
Send confidence test result status byte of previously performed test (Command A).
<STX>[confidence]<CR>

Bit	Confidence
0	always 0
1	0= NOVRAM Test Pass
	1= NOVRAM Test Fail
2	always 0
3	0= RAM Test Pass
	1= RAM Test Fail
4	0= ROM Test Pass
	1= ROM Test Fail
5	always 0
6	0= New Status Read
	1= New Status Available
7	parity

Command: E (45h)

Response
Scale is placed in echo mode. All subsequent characters (except F) are not treated as commands. These characters are echoed back to the host.
<STX>E<CR>

Command: F (46h)

Response
Scale is taken out of echo mode. All subsequent characters are commands.
<STX>F<CR>

Command: all others

Response
Unrecognized command
<STX>?[status]<CR>

Table 7.6 Summary of Command and Response:

Command		Response
ASCII	HEX	
W	57	Read scale weight: <STX>W ₁ W ₂ W ₃ W ₄ <DP>W ₅ U ₁ U ₂ U ₃ U ₄ U ₅ <CR>---normal data
Z	5a	<STX>?[status]<CR>
H	48	1. normal data <STX>W ₁ W ₂ <dp>W ₃ W ₄ W ₅ W ₆ <CR> -- weight data (x10) 2. if current weight is invalid <STX>?<Status Byte><CR>
A	41	<STX>?<CR>
B	42	<STX>[confidence]<CR?>
E	45	<STX>E<CR>
F	46	<STX>F<CR>
others		<STX>?[status]<CR>

7.6.4 Parameter Multi

Set the USER-COM-LYOUT parameter to mutli.

Output string frame
Command: W<CR> (57h 0dh), request current reading
<LF><Prompt><p>W ₁ W ₂ W ₃ W ₄ W ₅ <DP>W ₆ U ₁ U ₂ U ₃ U ₄ U ₅ <CR>
Line number and content are determined by setting of USER-OUT-xxxx
<LF><Prompt>H ₁ H ₂ H ₃ H ₄ <CR>
USER-OUT-STATUS is set to YES
C<CR>
USER-OUT1/2-LINE is set to LINE1/2/3/4

The number of lank lines is determined by USER-OUT-LINE setting
<LF>
(1) The decimal point position is determined by CONFIG-PRIM.D (2) The unit position and bytes are determined by which current unit is used (3) The details of <Prompt> refer to the content in User submenu (4) In HOLD mode, if ADC conversion speed is set to high speed (80Hz) and USER-COM-LYOUT is set to MULTI, the output from COM may be slower than the data processed by the indicator. For "real time" data, select fewer output contents and set a higher baud rate for C<CR> --- USER-OUT-LINE is set to LINE1/2/3/4
<LF> ---
---The number of blank lines is determined by USER-OUT1/2-LINE setting
<ETX>
--- Last byte of string frame

Example Layouts

When USER-OUT-xxxx is set to YES

Weighing Mode:

SCALE ID:	123456
GROSS:	123lb 4.56oz
TARE:	11lb 2.22oz
NET:	112lb 2.34oz
A/D CODE:	1234567
VOLTAGE:	5.7V
STATUS:	bpq2

Counting Mode:

SCALE ID:	123456
GROSS:	1234.55kg
TARE:	12.15kg
NET:	1222.40kg
QUANTITY:	24448pcs
PIECE WT:	0.05kg
A/D CODE:	1234345
VOLTAGE:	5.7V
STATUS:	bpq2

7.6.5 Parameter EH-SCP (PS-60)

Set the USER-COM-LYOUT parameter to eh-scp

This protocol is compatible with Toledo PS60 protocol. The baud rate and data format is set by User menu.

Output Status Bit Meaning

Table 7.7 Status Bits

Bit	Status
0	0 = not in motion
	1 = in motion
1	0 = not over capacity
	1 = over capacity
2	0 = not under zero (positive polarity)
	1 = under zero (negative polarity)
3	0 = inside zero capture range
	1 = outside zero capture range
4	0 = not center of zero
	1 = center of zero
5	always 1
6	always 1
7	parity

Summary of Command and Response

Command		Response
ASCII	HEX	
W	57	Read scale weight: <STX>W ₁ W ₂ <DP>W ₃ W ₄ W ₅ <CR>---normal data <STX>?[status]<CR>--if current weight is invalid
S	53	Read scale status: <STX>?[status]<CR>
Z	5a	Simulate ZERO key: <STX>?[status]<CR>
T	54	Simulate TARE key: <STX>?[status]<CR>
X	58	Simulate OFF key: power off the scale
others		Unknown commands: <STX>?[status]<CR>

7.6.6 Parameter IBM

Set the USER-COM-LYOUT parameter to ibm.

Command: <US> W (1Fh 57h), request current reading

Response
<STX>W ₁ W ₂ <dp>W ₃ W ₄ W ₅ <CR>---normal data
Note: (1) The decimal point position is determined by CONFIG-PRIM.D (2) If current unit is "lb:oz", the format will be similar with following:
<STX>W ₁ W ₂ W ₃ lbW ₄ W ₅ <dp>W ₆ oz<CR>

Command: <US> Z (1Fh 5ah)

Response
Zero function is activated (simulate ZERO key) and it returns to current scale status.
<STX>?[status]<CR>

If ZERO function cannot be activated, it will return to current scale status.

Table 7.8 Status Bits

Bit	Status
0	0 = not in motion
	1 = in motion
1	0 = not over capacity
	1 = over capacity
2	0 = not under zero (positive polarity)
	1 = under zero (negative polarity)
3	0 = inside zero capture range
	1 = outside zero capture range
4	0 = not center of zero
	1 = center of zero
5	always 1
6	always 1
7	parity

Command: <US> H (1Fh 48h)

Response
Send high resolution weight dat (x10)
<STX>W ₁ W ₂ <dp>W ₃ W ₄ W ₅ W ₆ <CR>---normal data
Note: (1) The decimal point position is determined by CONFIG-PRIM.D (2) If current unit is "lb:oz", the format will be similar with following:
<STX>W ₁ W ₂ W ₃ lbW ₄ W ₅ W ₆ <dp>W ₇ oz<CR>

Command: <US> A (1Fh 41h)

Response
Scale initiates a test of RAM, ROM and NOVRAM. Places the result into confidence test status byte for future interrogation by the host. It also returns acknowledgement.
<STX>?<CR>

Command: <US> B (1Fh 42h)

Response
Send confidence test result status byte of previously performed test.
<STX>[confidence]<CR>

Bit	Confidence
0	always 0
1	0= NOVRAM Test Pass
	1= NOVRAM Test Fail
2	always 0
3	0= RAM Test Pass
	1= RAM Test Fail
4	0= ROM Test Pass
	1= ROM Test Fail
5	always 0
6	0= New Status Read
	1= New Status Available
7	parity

Command: <US> E (1Fh 45h)

Response
Scale is placed in echo mode. All subsequent characters (except F) are not treated as commands. These characters are echoed back to the host.
<STX>E<CR>

Command: <US> F (1Fh 46h)

Response
Scale is taken out of echo mode. All subsequent characters are commands.
<STX>F<CR>

Command: all others

Response
Unrecognized command
<STX>?[status]<CR>

Table 7.9 Summary of Command and Response:

Command		Response
ASCII	HEX	
<US> W	1F 57	1. normal data <STX>W ₁ W ₂ <dp>W ₃ W ₄ W ₅ <CR> 2. if current weight is invalid <STX>?<Status Byte><CR>
<US> Z	1F 5a	<STX>?[status]<CR>
<US> H	1F 48	1. normal data <STX>W ₁ W ₂ <dp>W ₃ W ₄ W ₅ W ₆ <CR> -- weight data (x10) 2. if current weight is invalid <STX>?<Status Byte><CR>
<US> A	1F 41	<STX>?<CR>
<US> B	1F 42	<STX>[confidence]<CR?>
<US> E	1F 45	<STX>E<CR>
<US> F	1F 46	<STX>F<CR>
others		<STX>?[status]<CR>

8 Legal for Trade

The 67XXU Model must be configured to meet regulations mandated by local weights and measures authorities.

8.1 Physical Seal

The configuration/calibration push button is used to protect the scale from being configured or calibrated under legal for trade conditions. When set to legal for trade and sealed with a lead seal, the scale can only be configured and calibrated by authorized personnel.

The push button is located under the center screw on the underside of the scale. Remove the center screw. Press the button with a non-metallic object or a #0 phillips screwdriver.



CAUTION!

Do not use a flat blade screwdriver or other small metallic object as this could damage the scale!

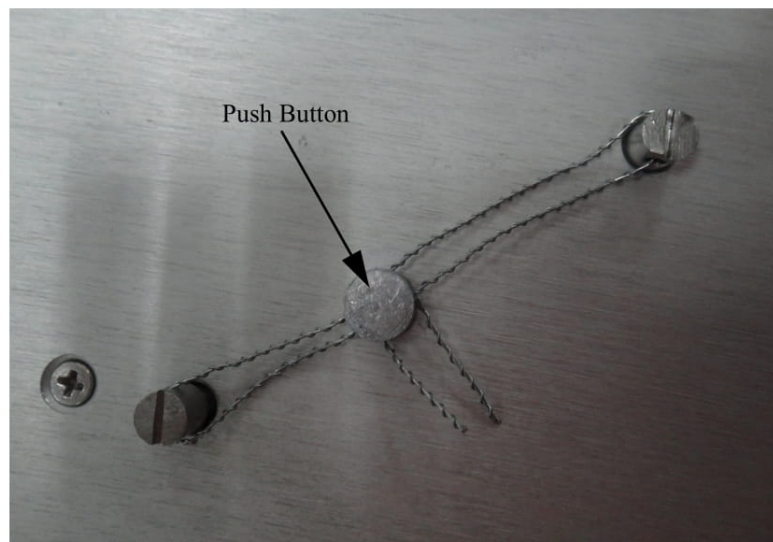

Figure 8.1 Physical Seal Location

8.2 Audit Trail Parameters

Two separate incrementing, non-resetable audit trail parameters are used to indicate changes to various parameters or calibration.

8.2.1 View Configuration Counter

1. Press and hold the **[HOLD] + [ON/OFF]** key for 3 seconds. CONFIG is displayed.
2. Press the **[TARE]** key to view the configuration counter.
- 2a. The display will briefly show the number of times the configuration has been changed and will save up to 9999. This counter can't be modified or erased. It counts from 0000 to 9999. When 9999 is reached, the counter starts over at 0000. The display will then show whether the configuration switch is on (cf.on) or (cf.off) off.

To Exit:

1. Press the **[ON/OFF]** key twice. Exit? is displayed.
2. Press the **[TARE]** key to return to the working mode.

8.2.2 View Calibration Counter

1. Press and hold the **[HOLD] + [ON/OFF]** key for 3 seconds. CONFIG is displayed.
2. Use the **[PRINT]** key to select the CAL menu.
3. Press the **[TARE]** key to enter the calibration mode.
- 3a. After entering this mode, the number of calibrations will be shown first. This number will be increment one digit after every time a calibration has been performed and saved. This counter can't be modified or erased. It counts from 0000 to 9999, when 9999 is reached, the counter starts over at 0000.
4. After the counter number was displayed, it will show "Ca.OFF" or "CAL-ON" which depends on whether the sealed calibration switch is OFF or ON. **If the switch is OFF, the following steps can be done, but the result will not be saved.**





































To Exit:

1. Press the **[ON/OFF]** key twice. Exit? is displayed.
2. Press the **[TARE]** key to return to the working mode.

9 Troubleshooting

This chapter gives explanations on commonly seen errors, display characters and display symbols.

9.1 Display Characters

ASCII	LCD/LED	ASCII	LCD/LED	ASCII	LCD/LED
0		A		N	
1		B		O	
2		C		P	
3		D		Q	
4		E		R	
5		F		S	
6		G		T	
7		H		U	
8		I		V	
9		J		W	
		K		X	
		L		Y	
		M		Z	

9.2 Display Symbols

Symbol	Description
0----	Zero is over the setting range
0_____	Zero point is below the setting range
Ad----	Signal to ADC is over maximum range
Ad_____	Signal to ADC is below minimum range
----	Weight is over upper limitation or display data is over limitation
_____	Weight is below lower limitation
EEP.E1	CONFIG or CAL parameters are not correctly set
EEP.E2	USER parameter is not correctly set
Lo.bAt	Battery voltage is lower than setting
CAP.- - -	Next displaying content is capacity
CAP.ER	Parameters about Capacity is not correct
CAL.Px	Calibration on point (x)
CAL.OFF	Calibration seal switch is on OFF position
CAL.ON	Calibration seal switch is on ON position
CAL.Er	Calibration error, maybe input data or loaded weight is incorrect, unstable, non-linear
CA.End	End calibration
OFF	Power OFF the indicator
STB.ER	Unstable time is larger than setting of USER-OTHER-NLD.RNG
PR.TAR	Preset TARE weight
COMP	Input COMPARE data mode
HIGH	Input HIGH limitation data of Comparison
LOW	Input LOW limitation data of Comparison
SPL.Lo	Sample load weight of low point.
SPL.HI	Sample load weight of high point.

Symbol	Description
SPL.PW	Sample goods weight to calculate piece weight
IN.PCS	Input number of pieces being counted
UNT.KG	Unit kg is selected
UNT.LB	Unit lb is selected
PWT.ER	Piece weight error, sample too small (<0.5d)

9.3 Error Messages and Troubleshooting

Symptom	Probable Cause	Remedy
Ad---	Loadcell wires to indicator are incorrectly connected, shorted, opened, ADC or loadcell(s) are damaged.	Make sure wires are ok and correctly connected. Replace loadcell or ADC chip, Service required.
Ad__		
0----	Weight reading exceeds Power On Zero limit.	Make sure scale platform is empty. Perform zero calibration.
0__	Weight reading below Power On Zero limit.	Install platform on scale. Perform zero calibration.
----	Weight reading exceeds Overload limit or the weight value cannot be displayed in the current unit of measure because it exceeds 6 digits.	Reduce load on scale until weight value can be displayed. Use a more appropriate unit of measure. Re-set some parameters of CONFIG or USER.
__	Weight reading below Under load limit.	Install platform on scale. Perform zero calibration.
EEP.E1	CONFIG or CAL parameters are not correctly set.	Re-set items in CONFIG, do calibration.
EEP.E2	USER parameter is not correctly set.	Re-set items in USER.
CAP.ER	Capacity parameters are not correct.	Set PRIM.N/PRIM.D/SECND.n to correct number, make sure capacity not more than 6 digit.
CAL.Er	Calibration error. Input data or loaded weight is too small, too big, unstable, non-linear.	Input correct data, load correct weight onto platform, Service required.
PWT.ER	Piece weight is error, it's too small (<0.5d), The weight on the platform is too small to define a valid reference weight.	Use a greater weight for the sample.

Symptom	Probable Cause	Remedy
PCT.ER	Unit-Percentage -Weight is error, it's too small (the weight of 1%, 0.1%, or 0.01%-determined by CONFIG-FUNC-PERCNT is less than 0.5d).	Use more weight for the sample.
STB.ER	USER-HOLD-STB.TIM is too short, USER-HOLD-HLD.RG is too small, other failure.	Set USER-HOLD-STB.TIM longer, or set USER-HOLD-HLD.RG bigger. Service required.
Will not turn on.	Power cord not plugged in or properly connected. Power outlet not supplying electricity. Battery discharged. Other failure.	Check power cord connections. Make sure power cord is plugged into the power outlet. Check power source. Replace batteries. Service required.
Cannot zero the display or will not zero when turned on.	Load on scale exceeds allowable limits. Load on scale is not stable. Load cell damage.	Remove load on scale. Wait for load to become stable. Service required.
Cannot display weight in desired weighing unit.	Unit not set to enable or d≥5oz, when unit is lb:oz.	Enable unit in CONFIG-UNITS.