

# AE 403 Series Indicator Service Manual

Software revisions V1.00 and above



**Easy Reference:**

Model name of the scale:	
Serial number of the unit:	
Software revision number (Displayed when power is first turned on):	
Date of Purchase:	
Name of the supplier and place:	

# 1.0 CONTENTS

(P.N. 31066 14213, Revision B, October 2019)

1.0 CONTENTS .....	1
2.0 INTRODUCTION .....	2
3.0 SAFETY .....	2
4.0 PANEL INTERFACES .....	3
4.1 POWER.....	3
4.2 DATA INTERFACES .....	3
4.3 LOAD CELL INTERFACES.....	3
4.4 RELAY INTERFACES.....	3
5.0 INDICATOR MENUS .....	4
5.1 SUPERVISOR MENUS.....	4
5.1.1 "AdCnE" .....	5
5.1.2 "duAL" .....	5
5.1.3 "APPPrO" .....	6
5.1.4 "CAPA".....	6
5.1.5 "Auto-2" .....	6
5.1.6 "P-2ErO".....	6
5.1.7 "k-2ErO" .....	7
5.1.8 "F iLLEr".....	7
5.1.9 "G I".....	7
5.1.10 "G2".....	7
5.1.11 "L inEAR" .....	8
5.1.12 "i-r-tArE" .....	8
5.1.13 "dot".....	8
5.1.14 "C-Con".....	9
5.1.15 "rESEt".....	9
5.2 DEALER MENUS.....	9
5.2.1 "L-CAL" .....	10
5.2.2 "AdC".....	11
5.2.3 "GrAU it" .....	11
5.3 USER MENUS .....	11
6.0 INDICATOR PARAMETERS .....	12
7.0 RS-232 PARAMETERS RS232 .....	15
7.1 Print settings .....	15
7.2 PC settings.....	16
7.3 RS-232 INTERFACE .....	16
8.0 CONNECTION OF LOAD CELL .....	17
8.1 Connector Assembly .....	17
8.2 Load cell wire solder with PCB.....	18
9.0 U-BRACKET ASSEMBLY.....	22
10.0 CHANGING LOAD CELL AND RS232 CABLE.....	22
11.0 CHANGING BATTERY or BATTERY CABLE.....	25
12.0 CHANGING TRANSFORMER.....	26
13.0 CHANGING OVERLAY.....	28
14.0 ACCESSORIES & SPARE PARTS .....	28

## **2.0 INTRODUCTION**

This Service Manual will guide you through the normal service and calibration procedures necessary to maintain the indicator. Please read this Manual thoroughly before performing any service. This manual should be used in conjunction with the User operation manual.

## **3.0 SAFETY**

### **HIGH VOLTAGE**



The indicator has high voltage inside. This high voltage can be lethal.

When using the indicator, indicator power plug must connect to a reliable earthed external power.

When service the indicator, power must be disconnected, it is essential to separate display plug from external power.

## 4.0 PANEL INTERFACES

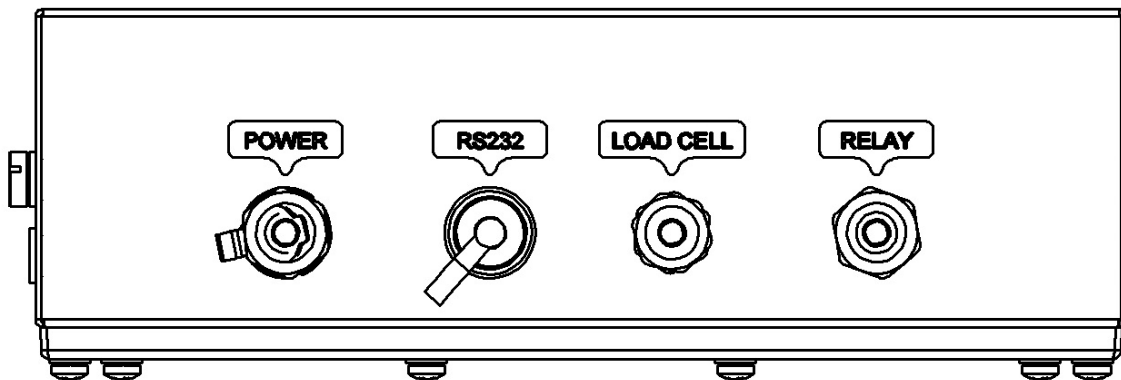

The indicator has connectors for the power, data interface, load cell and Relay (option).

### 4.1 POWER

Make certain your indicator is compatible with the mains power supply in your area. If the voltage is not the same the indicator can be damaged.

### 4.2 DATA INTERFACES

The indicator has data interfaces for a variety of applications.

The RS232 interface is a general purpose serial interface for communications with the indicator, using a connector.

See the User manual section 9.0 for more details.

### 4.3 LOAD CELL INTERFACES

The indicator has load cell interfaces option, so user can connect it to a weighing platform for using.

Due to approval or special requirement for application, some indicator models need the user to connect load cell wire to the PCB board.

**See section 11 for more installation details.**

### 4.4 RELAY INTERFACES

The indicator has relay interfaces option. If you need this option, please contact Adam Equipment or your dealer.

See the User manual section 10.0 for more details.

## 5.0 INDICATOR MENUS

The AE 403 has a number of submenus for setting the operation of the indicator and the communications. In addition to the Supervisors menu for setting the indicator to the needs of the user, there is a Dealer menu that allows a service person to calibrate the indicator, observe the ADC counts from the load cell.

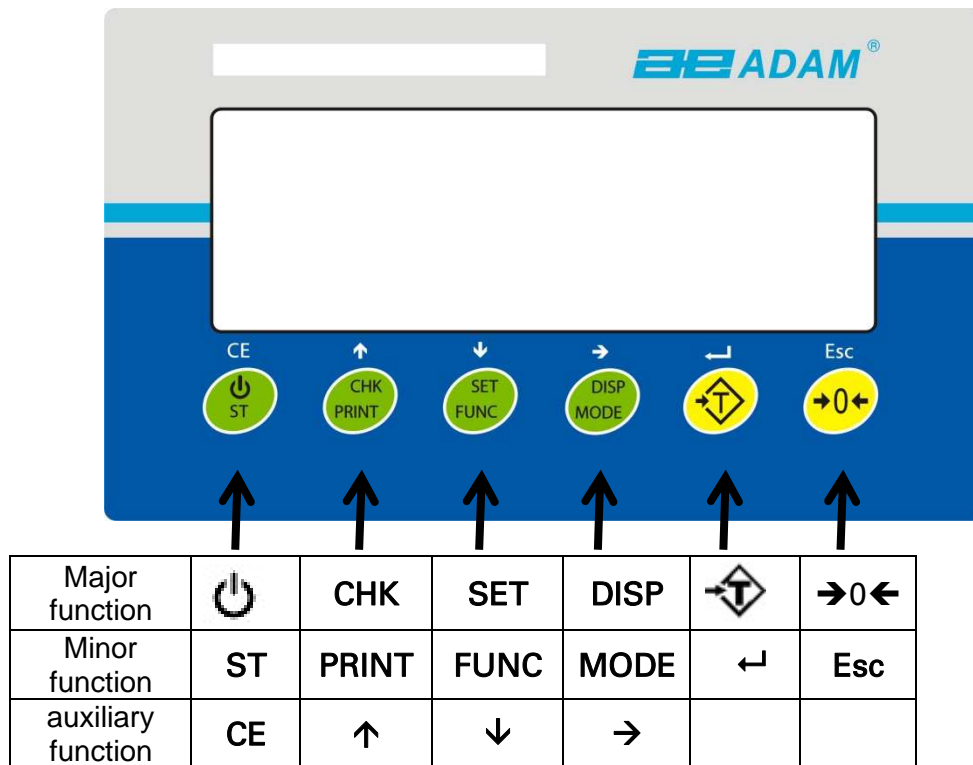

All the operations can be performed by the keypad. See user manual section 4.0 for specific keypad function.

### 5.1 SUPERVISOR MENUS

- Press and hold the [ ] key about 2 seconds to turn on the indicator, and wait for the scale to do self-test.
- Before self-test completes, press the [↵] key when "P " is displayed, enter the supervisor password information.
- To enter the password, use the directional buttons [↑] to scroll through numbers 1-9. Use the [→] directional key to move to the next digit.
- Entering the correct password [1946] will bring you to the supervisor menu. The displays will show the first parameters, called "AdCnE".

- Press the [←] key to enter a parameter, the display will guide you through the parameter selected and the options available.
- To exit a parameter, press the [Esc].
- Press [↑] or [↓] key to select other parameters.
- Press the [Esc] key again to return to weighing.

The display will show the available parameters:

1	"AdCnt"	Display the A/D counts
2	"dual"	whether dual division or dual capacity is necessary
3	"APPr"	Approval type
4	"CAPA"	Capacity
5	"Auto-Z"	Zero tracking range
6	"P-ZEr"	Zero rang when power on
7	"k-ZEr"	Key zero range
8	"Filter"	Filter mode and range
9	"G1"	Gravitational acceleration at place of manufacture
10	"G2"	Gravitational acceleration at place of use
11	"LineAR"	Linearity calibration
12	"tareAR"	Tare display mode
13	"dot"	Setup dot or comma as decimal
14	"E-Con"	Calibration control
15	"rESEt"	Reset all parameters

### 5.1.1 "AdCnt"

Press the [←] key to enter this parameter. This parameter allows you to view the A/D counts from the internal A/D converter.

This can be an aid to service.

The weight ADC counts are normally stable within a few counts if the load cell is functioning correctly, the environment is stable and the temperature is stable. The range of the ADC counts will depend upon the load cell used and if the bracket is in place or not.

### 5.1.2 "dual"

This parameter is dual range.

Press the [↵] key to enter this parameter, display will show "nonE". Use [↑] or [↓] key to change parameter, there are "nonE", "d-rAn G ", "d-d L'" options available to select, press [↵] to accept the selected parameter. "d-rAn G " is dual range, "d-d L'" is dual division.

### 5.1.3 "APPrO"

This parameter is for approvals

Press the [↵] key to enter this parameter, display will show "nonE". Use [↑] or [↓] key to change parameter, there are "nonE", "o uL", "5R", "Au5", "nLEP" options available to select, press [↵] to accept the selected parameter.

### 5.1.4 "CAPA"

This parameter sets unit, decimal point, capacity & division

Press the [↵] key to enter this parameter, display will show "dEL". Use [↑] or [↓] key to change parameter, there are 0, 0.0, 0.00, 0.000, 0.0000 parameters available to select, press [↵] to accept the selected parameter.

When the display shows "KG", use [↑] or [↓] key to change the parameter. There are two options "KG" and "Lb", press [↵] to accept the selected parameter.

The display will show "CAPA H", then jump to number "0". Press [CE] key can clear all the original readings. Use [↑] or [↓] key to change the parameter and press [→] key to move to the next digit. Press [↵] key to accept the selected parameter.

The display will show "inE H", then jump to reading "0.00 I". Use [↑] or [↓] key to change the parameter and select suitable precision. There are 1, 2, 5, 10 parameters available to select. After selecting the suitable precision, press [↵] to accept the selected parameter.

### 5.1.5 "Auto-2"

This parameter sets the Auto zero range

Press the [↵] key to enter this parameter, display will show "2.0". Use [↑] or [↓] key to change parameter, there are 0.5, 1.0, 1.5, 2.0, 2.5, 3.0 parameters available to select, press [↵] to accept the selected parameter.

### 5.1.6 "P-2ErO"

This parameter sets the power on zero range



Press the [↵] key to enter this parameter, the display will show "10". Use [↑] or [↓] key to change parameter, there are 0FF, 1, 2, 5, 10, 20, 50, 100 parameters available to select, press [↵] to accept the selected parameter.

### 5.1.7 "k-ZEr0"

This parameter is for approved units only to set the allowable range for zero when key pressed

Press the [↵] key to enter this parameter, the display will show "4". Use [↑] or [↓] key to change parameter, there are 1, 2,4,5,10,20 parameters available to select, press [↵] to accept the selected parameter.

### 5.1.8 "F iLEr"

This parameter sets the filter

Press the [↵] key to enter this parameter, the display will show "R CLR". Use [↑] or [↓] key to change parameter, there are "SL0LEr", "SL0LES", "FASTES", "FAStEr" parameters available to select, press [↵] to accept the selected parameter and move to the next menu.

Use [↑] or [↓] key to change the parameter and press [↵] to accept the selected parameter.

### 5.1.9 "G l"

This parameter sets the gravity zone

Press the [↵] key to enter this parameter, the display will show a value. Use [↑] or [↓] key to enter the actual acceleration of gravity for calibration location, then press [↵] to accept.

### 5.1.10 "G2"

This parameter allows you to select a pre-set gravity zone

Press the [↵] key to enter this parameter, display will show "u5Er". Use [↑] or [↓] key to change parameter, there are "u5Er", "u k ", "Fr 1", "Fr2", "Fr3", "Fr4", "nL", "GE", "iRA", "SA", "u5A", "Au5" parameters available to select, press [↵] to accept the selected parameter.

If the location is not included in the area above, please select "u5Er", the display will show a value, press [CE] key can clear original readings. Use [↑] or [↓] key to change the parameter, use [→] key to move to the next digit, enter the actual acceleration of gravity for operation location and press [↵] to accept.

### 5.1.11 “L inER”

This parameter allows you to do linearity calibration

- Press [↵] key to access linearity calibration parameter, the display will show “~noLoAd”. Make sure the weighing platform is empty and press [↵] key to accept.
- The display shows “KG”, use [↑] or [↓] key to change the parameter. There are “KG” and “Lb” parameters, press [↵] to accept the selected parameter.
- The display shows “LoAd 1”, then jumps to “1.000”, the last digit is flashing. Press [CE] key can clear original readings. Use [↑] or [↓] key to change the parameter, use [→] key to move to the next digit. Generally load 1 is set to 1/2 of the capacity. Select integer for actual weight and press [↵] to accept.
- When the display shows “~LoAd”, put specified weight on the weighing platform. When stable symbol appears again, press [↵] to accept.
- The display shows “~LoAd 2”, then jumps to “3.000”, the last digit is flashing. Press [CE] key can clear original readings. Use [↑] or [↓] key to change the parameter, use [→] key to move to the next digit. Generally load 2 is set to full capacity. Select integer for actual weight and press [↵] to accept.
- When the display shows “~LoAd”, put specified weight on the weighing platform. When stable symbol appears again, press [↵] to accept.
- Software will restart and display weighing status, now linearity calibration completes.

### 5.1.12 “TARE”

This parameter sets automatic tare

Press the [↵] key to enter this parameter, the display will show “A CLR”. Use [↑] or [↓] key to change parameter, there are “A CLR” and “d 5P” parameters available to select, press [↵] to accept the selected parameter. “A CLR” automatically clears the tare when the reading goes to zero, “d 5P” shows the tare value, and only allows, manual clearing of the tare.

### 5.1.13 “dot”

Sets whether the decimal point is displayed as a dot or a comma.

Press the [↵] key to enter this parameter, the display will show "dot". Use [↑] or [↓] key to change parameter, there are "dot" and "C000" parameters available to select, press [↵] to accept the selected parameter.

#### 5.1.14 "C-000"

For approved units only, this parameter sets the calibration control

Press the [↵] key to enter this parameter, the display will show "C000". Use [↑] or [↓] key to change parameter, there are "C000" and "JUMP" parameters available to select, press [↵] to accept the selected parameter. "C000" increments each time the indicator is calibrated, which can then be used for traceability, "JUMP" calibration can only occur when a jumper is fitted.

Note: if you select "JUMP" and accept it, you can only access the menu through the jumper on the PCB.

#### 5.1.15 "rE5E5"

This parameter is factory reset.

Press the [↵] key to enter this parameter, the display will show "r0". Use [↑] or [↓] key to change parameter, there are "r0" and "Y55" parameters available to select, press [↵] to accept the selected parameter.

Note: if you select "Y55" and accept it, all parameters will reset to factory and the indicator will restart.

Details of these menus are given in the User manual section 12.

## 5.2 DEALER MENUS

The dealer has access to a menu to allow calibration of weight without the normal limitations put on the calibration during the user methods of setting them. In addition it is possible to view the values delivered from the analog to digital converter for both the chamber temperature and the weight.

This section describes the parameters available to the dealers for setting up the indicator. Access to these parameters is controlled by password.

- Press and hold the [  ] key about 2 seconds to turn on the indicator, and wait for the scale to configure.



- Before configuration is completed, press the [↵] key, when "P" is displayed, enter the dealer password information screen.

- To enter the password, use the directional buttons [↑] to scroll through numbers 1-9. Use the [→] directional key to move to the next digit.

- Entering the correct password [1966] will bring you to the supervisor menu. The display will show the first parameters, called "L-*CAL*".

- Press the [↵] key to enter a parameter, the display will guide you through the parameter selected and the options available.

- To exit a parameter, press the [Esc]

Use the [↑] or [↓] directional key to select other parameters.

- Press the [Esc] key again to return to weighing.

The display will show the parameters available:

1	"L- <i>CAL</i> "	Linearity calibration
2	" <i>AdC</i> "	Display the A/D counts
3	" <i>GRAV iL</i> "	Gravitational acceleration at place of use

### 5.2.1 "L-*CAL*"

- Press [↵] key to access linearity calibration parameter, the display will show "*noLoAd*". Make sure the weighing platform is empty and press [↵] key to accept.

- The display shows "KG", use [.] or [↓] key to change the parameter. There are "KG" and "*Lb*" parameters, press [↵] to accept the selected parameter.

- The display shows "*LoAd 1*", then move to "*1.000*", the last digit is flashing. Press [CE] key can clear original readings. Use [↑] or [↓] key to change the parameter, use [→] key to move to the next digit. Generally load 1 is set to 1/2 of the capacity. Select integer for actual weight and press [↵] to accept.

- When the display shows “~L0Ad”, put specified weight on the weighing platform. When stable symbol appears again, press [↵] to accept.

- The display shows “~L0Ad 2”, then jumps to “3.000”, the last digit is flashing. Press [CE] key can clear original readings. Use [↑] or [↓] key to change the parameter, use [→] key to move to the next digit. Generally load 2 is set to full capacity. Select integer for actual weight and press [↵] to accept.

- When the display shows “~L0Ad”, put specified weight on the weighing platform. When stable symbol appears again, press [↵] to accept

- Software will restart and display weighing status, now linearity calibration completes.

### 5.2.2 “AdC”

Press the [↵] key to enter this parameter. This parameter allows you to view the A/D counts from the internal A/D converter.

This can be an aid to service.

The weight ADC counts are normally stable within a few counts if the load cell is functioning correctly, the environment is stable and the temperature is stable. The range of the ADC counts will depend upon the load cell used and if the bracket is in place or not.

### 5.2.3 “GrAvIt”

This parameter allows you to select a pre-set gravity zone

Press the [↵] key to enter this parameter, the display will show “u5Er”. Use [↑] or [↓] key to change parameter, there are “u5Er”, “u k”, “Fr1”, “Fr2”, “Fr3”, “Fr4”, “nL”, “GE”, “tR”, “SR”, “u5R”, “R5” parameters available to select, press [↵] to accept the selected parameter.

If the location is not included in the area above, please select “u5Er”, the display will show a value, press [CE] key can clear original readings. Use [↑] or [↓] key to change the parameter, use [→] key to move to the next number, enter the actual acceleration of gravity for operation location and press [↵] to accept.

## 5.3 USER MENU

The user has access to a menu to allow calibration of weight without the normal limitations put on the calibration during the user methods of setting them.

This section describes the parameters available to the dealer for setting up the indicator. Access to these parameters is controlled by password.

- Press and hold the [  ] key about 2 seconds to turn on the indicator, and wait for the scale to configure.



- Before configuration is completed, press the [←] key when "P " is displayed, enter the user password information screen.
- To enter the password, use the directional buttons [↑] to scroll through numbers 1-9. Use the [→] directional key to move to the next digit.
- Entering the correct password [1000] will bring you to the user menu. The displays will show the first parameters, called " ~L o R d " .
- Make sure the weighing platform is empty and press [←] key to accept.
- The display shows "L o R d 1", then jumps to " 1.000", the last digit is flashing. Press [CE] key can clear original readings. Use [↑] or [↓] key to change the parameter, use [→] key to move to the next digit. Generally load 1 is set to full capacity. Select integer for actual weight and press [←] to accept.
- When the display shows " ~L o R d " , put specified weight on the weighing platform. When stable symbol appears again, press [←] to accept.
- Software will restart and display weighing status, now user calibration completes.

## 6.0 INDICATOR PARAMETERS

- Pressing the [SET/FUNC] key and holding for 2 seconds during normal operation allows the user to access the parameters.
- Scroll through the list of functions using the [↑] and [↓] directional keys. Press [←] to enter a parameter.
- Press [Esc] to exit the scale parameter section and return to normal weighing.

This group of parameters is used to control the operation of the scale.

Parameter	Description	Options	Default setting
<b>time</b>	Set Time.	Enter the time manually.	<b>00:00:00</b>
<b>date</b>	Set date format and settings. Format for date can be changed when the display shows mmddyy, ddmmyy or yymmdd by pressing the [Pcs/↑] key, then enter the date.	Enter the date format and then the numeric value manually.	<b>mm:dd:yy</b>
<b>bl</b>	Backlight set to always on, always off or automatic on. Set color and brightness	<b>off, on, AUTO</b> <b>then: GREEN, RED, AMBER, BLUE, WHITE</b> <b>then: mid, high, low</b>	<b>AUTO</b>
<b>Power</b>	Disable or set time increment to turn off scale	<b>0, 1, 2, 5, 10, 15, Off</b>	<b>2</b>
<b>Key bp</b>	Key beeper settings	<b>On, Off</b>	<b>On</b>
<b>Chk bp</b>	Check weighing beeper settings	<b>In, Out, Off</b>	<b>In</b>
<b>Unit</b>	Enable or disable weighing units, will not allow to disable all units, at least one has to be enabled. Parts counting can be enabled/disabled	<b>Kg</b> <b>Grams</b> <b>lb</b> <b>oz</b> <b>lb:oz</b> <b>N (Newtons)</b> <b>PCS</b>	<b>Kg</b>
<b>Auto-Z</b>	Auto zero settings	0.5, 1, 1.5, 2, 2.5, 3	<b>0.5</b>
<b>Filter</b>	Filter setting to slow, normal or fast	<b>Slower, Slowest, Faster, Fastest</b> <b>Then: 1-6</b>	<b>Faster</b>
<b>Rs 1</b>	Brings up the 1 <sup>st</sup> RS232 menu. Includes PC, command and print settings	PC, Cmd, Print	
<b>Rs 2</b>	Brings up RS232 menu 2	PC, Cmd	
<b>S-id</b>	Set Scale ID	To be entered manually	000000
<b>U-id</b>	Set User ID	To be entered manually	000000
<b>rechar</b>	Indicates time to recharge	-	-

Parameter	Description	Options	Default setting
<b>time</b>	time setting	Manual input	<b>00:00:00</b>
<b>date</b>	Use [↑] and [↓] to select proper date format from mmddyy, ddmmyy, yymmdd and enter the date	Select date format and input correct date	<b>mm:dd:yy</b>
<b>bl</b>	Backlight set to always on, always off or automatic on. Set color and brightness	<b>off, on, AUTO</b> <b>then: GREEN, RED, AMBER, BLUE, WHITE</b> <b>then: mid, high, low</b>	<b>AUTO</b>
<b>Power</b>	Set auto power-off time	<b>0, 1, 2, 5, 10, 15, Off</b>	<b>2</b>
<b>Key bp</b>	Set keypad tone	<b>On, Off</b>	<b>On</b>
<b>Chk bp</b>	Set weight checking sound	<b>In, Out, Off</b>	<b>In</b>
<b>Unit</b>	Set weight unit	<b>Kg, Grams, lb, oz, lb:oz, N (Newtons), PCS</b>	<b>Kg</b>
<b>Auto-Z</b>	Auto zero setting	0.5, 1, 1.5, 2, 2.5, 3	<b>0.5</b>
<b>Filter</b>	Filter setting	<b>Slower</b> <b>Slowest</b> <b>Faster</b> <b>Fastest</b> <b>1-6 grade available to select</b>	<b>Faster</b>
<b>Rs 1</b>	Set 1# RS232 interface, including PC, command, print setting	PC, Cmd, Print	
<b>Rs 2</b>	Set 2# RS232 interface	PC, Cmd	
<b>S-id</b>	Set number for the scale	Manual input	-
<b>U-id</b>	Set operator number	Manual input	-
<b>rechar</b>	Display charging current	-	-



## 7.0 RS-232 PARAMETERS RS232

This group of parameters can be set by the user for setting the RS-232 active or not, baud rate, printing mode, accumulation mode, RS-232 language, and user or scale ID numbers.

- Pressing the **[Func/Set]** key and holding for 2 seconds during normal operation allows the user to access the parameters.
- Scroll through the list of functions using the [↑] and [↓] directional keys. Press [←] to enter the 'rs 1' or 'rs 2' parameters when appearing on the display.
- 'Rs 1' will provide access to 'Print' and 'PC' settings. 'Rs 2' includes 'PC' and 'Print'. Press [←] to confirm.
- When entering a mode, the user will be required to go through each step of the process by entering the desired values or selecting from the options listed in the table below and pressing the [←] key to confirm.
- Press **[Esc]** to exit the scale parameter section and return to normal weighing.

### 7.1 Print settings

Parameter	Description	Options	Default Values or setting
<b>[baud rate]</b>	Baud Rate	<b>1200</b> <b>2400</b> <b>4800</b> <b>9600</b> <b>19200</b> <b>38400</b> <b>57600</b> <b>115200</b>	<b>9600</b>
<b>[Language]</b>	Select Language	<b>EnGLis</b> (English) <b>FrEnCH</b> (French) <b>SPAn</b> (Spanish) <b>GErmAn</b> (German) <b>Itall</b> (Italian) <b>Portug</b> (Portuguese)	<b>EnGLis</b>
<b>[Accumulation]</b>	Enable or disable the Accumulation	<b>on</b> <b>off</b>	<b>off</b>
<b>[Printing model]</b>	Printing Mode- Manual or Automatic	<b>mAn</b> , <b>AUto P</b>	<b>mAn</b>
<b>[Printer/device]</b>	Select the printer or device to print to	<b>ATP</b> <b>LP50</b>	<b>ATP</b>
<b>[Number of copies]</b>	Select the number of copies	<b>Copy 1</b> <b>Copy 2</b> <b>Copy 3</b> <b>Copy 4</b> <b>Copy 5</b> <b>Copy 6</b> <b>Copy 7</b> <b>Copy 8</b>	<b>Copy 1</b>

<b>[Print layout]</b>	Select complex or simple print layout	<b>Comp</b> <b>Simp</b>	<b>Comp</b>
<b>[Line break]</b>	Select the number of line breaks between weight values on label.	<b>1 Lfcr</b> <b>2 Lfcr</b> <b>3 Lfcr</b> <b>4 Lfcr</b> <b>5 Lfcr</b> <b>6 Lfcr</b> <b>7 Lfcr</b> <b>8 Lfcr</b> <b>9 Lfcr</b> <b>none</b>	<b>none</b>

Indicator will perform the following, depending on the Accumulation and Print Settings:

	<b>AC on</b>	<b>AC Off</b>
<b>AUTO</b>	Accumulate and print automatically	Print automatically, Do not accumulate
<b>mAn</b>	Accumulate and Print only when [CHK/PRINT/↑] key pressed. If [CHK/PRINT/↑] is pressed a second time only print the weight.	Print when [CHK/PRINT/↑] key is pressed, Do not accumulate.

## 7.2 PC settings

Parameter	Description	Options	Default Values or setting
<b>[baud rate]</b>	Baud Rate	<b>1200, 2400, 4800, 9600, 19200, 38400, 57600, 115200</b>	<b>9600</b>
<b>[Model]</b>	Select the scale/model being used.	<b>Adam</b> <b>CBK</b> <b>NBL</b>	<b>Adam</b>
<b>[Intervall]</b>	Select the interval per second for sending data to a PC.	<b>0(continuous) -6.0</b>	<b>Int 6.0</b>

## 7.3 RS-232 INTERFACE

The AE 403 indicator is supplied with bi-directional RS-232 interface as standard. The scale when connected to a printer or computer outputs the weight with the selected weighing unit through the RS-232 interface.

Specifications:

RS-232 output of weighing data  
ASCII code  
9600 Baud (user selectable)  
8 data bits  
No Parity

RS-232 serial interface is a plug as figure 2 shows:

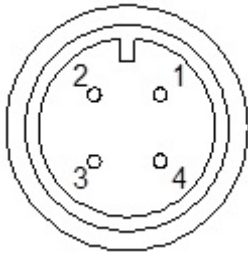

1: Pin GND, Signal Ground  
2: Pin RXD, Received Data  
3: Pin TXD, Transmitted Data

## 8.0 CONNECTION OF LOAD CELL

### 8.1 CONNECTOR ASSEMBLY

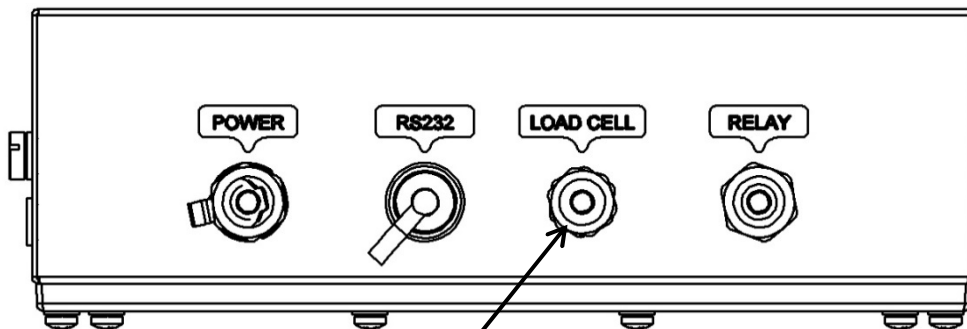

If there is a metal dust cap at the indicator load cell interface, you need to screw it out anticlockwise, then you can see a plug like the picture below shows.



6: Pin +IN +Signal  
7: Pin -IN -Signal  
3: Pin AGND Shield  
1: Pin +E, +Excitation  
2: Pin +S +Sense  
4: Pin -E -Excitation  
5: Pin -S -Sense

Take out the connector from the box and solder it to load cell wire with the orders above correctly, then connect the connector to the indicator.



**Note:**

For 4 wire load cell, connect the load cell +Excitation and +Sense together at the connector and -Excitation and -Sense together at the connector.

## 8.2 LOAD CELL WIRE AND PCB SOLDERING

If there isn't a metal cover at load cell interface, but a rubber cap, then connect the load cell wire to the indicator correctly as the following steps. *Before connecting the wire, please make sure external power has been cut off.*

**8.2.1** Screw out 12 screws at the back of the indicator with correct tool and keep the screws properly.

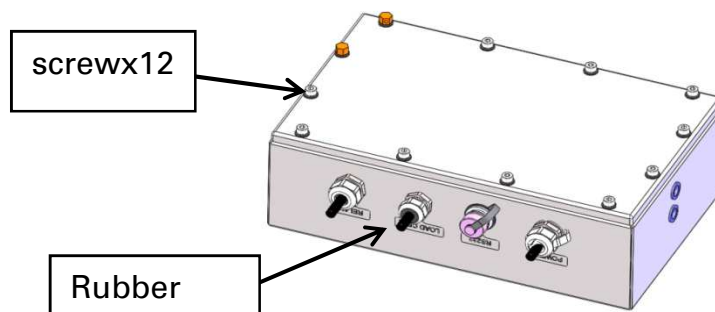

**8.2.2** Open the back cover of the indicator. To make it is safe, battery wire must be unplugged.



Unplug battery wire

**8.2.3** Screw out the nut outside load cell waterproof cap with correct tool, take out the rubber cap. Pay attention that the nut underneath is not allowed to loose. Then go through load cell wire to the inside of the indicator.



Screw out this nut anticlockwise, then take out the rubber cap

rubber plug, go through load cell wire as the picture shows, then plug inside the indicator

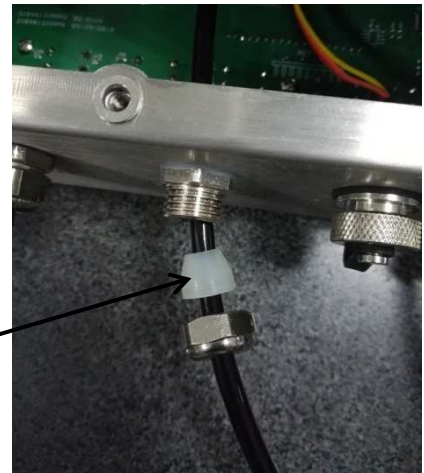

**8.2.4** Remove the screw fixing the PCB, generally 4pcs, for some models might be 5pcs. Lift up the PCB board carefully.

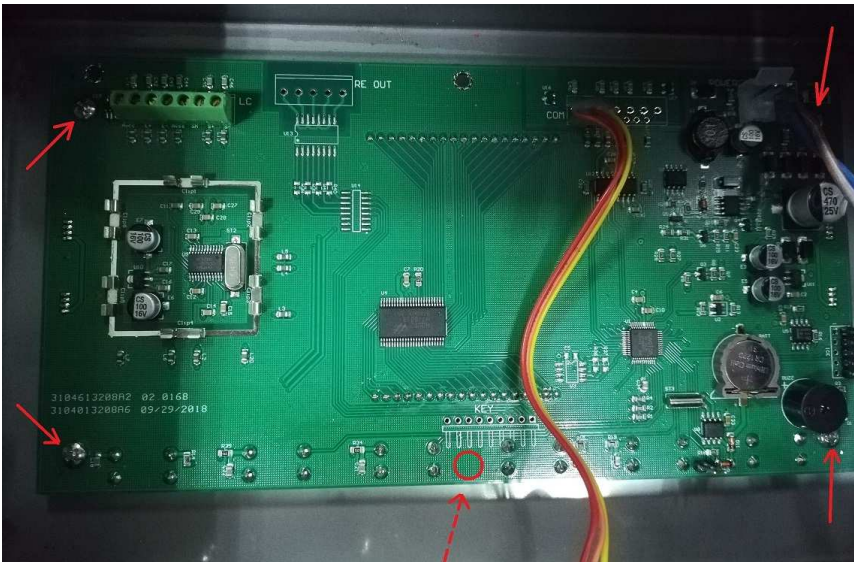

**8.2.5** Loosen the upper screws on load cell wire terminal, then plug load cell wire to the hole on the side of wire terminal and screw the upper screw tight. Make sure the connection between load cell wire and wire terminal is reliable.

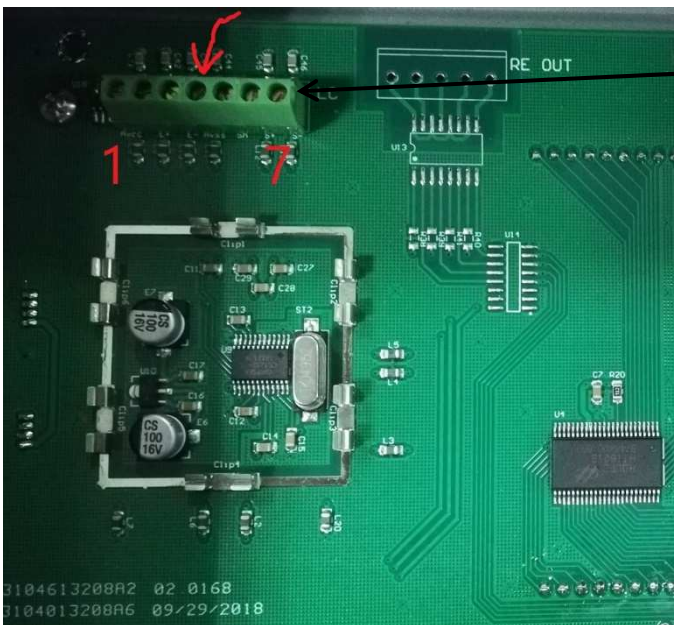

Loosen upper screw, plug the load cell cable from the side hole, then tighten the upper screw

- Pin1 Avcc: +Sense
- Pin2 E+: +Excitation
- Pin3 E-: - Excitation
- Pin4 Avss: -Sense
- Pin5 Sh: Shield
- Pin6 S+: +Signal

**Note:**

For 4 wire load cell, connect the load cell +Excitation and +Sense together at the connector and -Excitation and -Sense together at the connector.

**8.2.6** Put back the screws removed in section 11.2.4 to fix the PCB, then connect battery wire.

**8.2.7** As mentioned in section 5.2, access 5.2.2 ADC menu when power on, you can see an AD count. Press the weighing frame or weighing platform with your hand. **When you can see the value is increasing, it indicates load cell connection is correct. Otherwise, you need to connect it again.**

**8.2.8** Reserve proper wire length inside the indicator and screw tight the nut outside the load cell waterproof end cap.



Fit the nut and screw it tight. When the connector attaching the case starts turning, stop putting forth.

**8.2.9** Put the rubber sealing ring on the front indicator, then put the rear cover back. Fit the screws removed in section 11.2.1 and screw them tight. Make sure the rubber sealing ring is flat and all the screws must go through the sealing ring correctly. You'd better use a torque spanner to tight it, torque: 1N.m. When tightening the screws, tighten screws from alternate sides, until all the screws are tightened. Do NOT tighten screws working from one screw to the screw next and so on. After tightening it, the clearance between front cover and rear surroundings should be consistent.

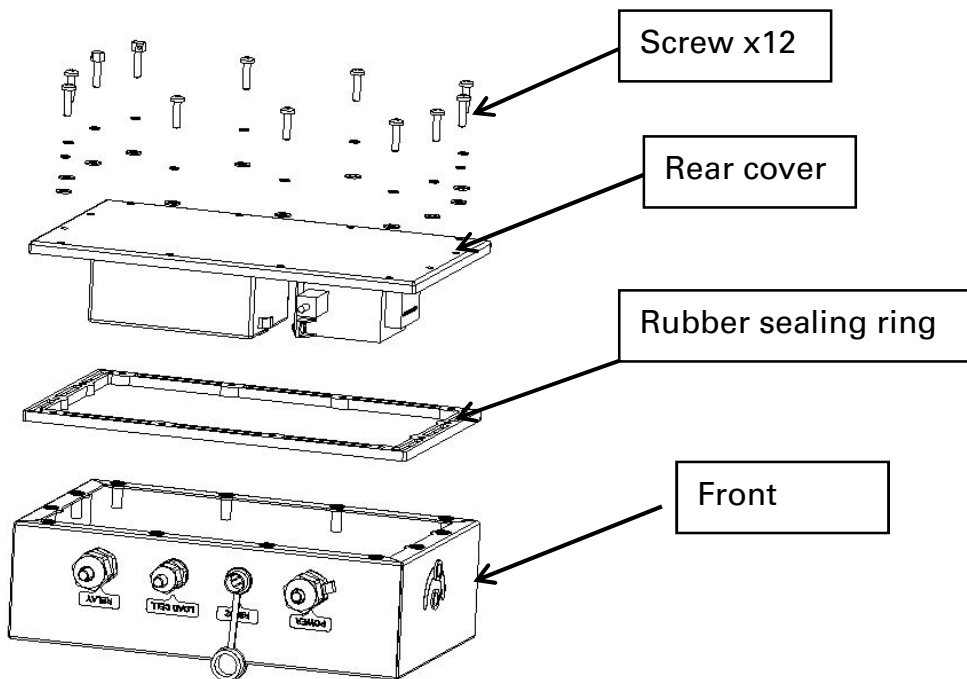

## 9.0 U-BRACKET ASSEMBLY

User has the option to install U bracket to use the indicator. With the U bracket, user can fix or hang the indicator to a certain position.

Take out the screws and pentacle handle from the indicator packaging. Fit the U bracket as the picture shows, align 4 holes on the indicator and tighten the fixing screws. Finally adjust the display with pentacle handle and tighten it.

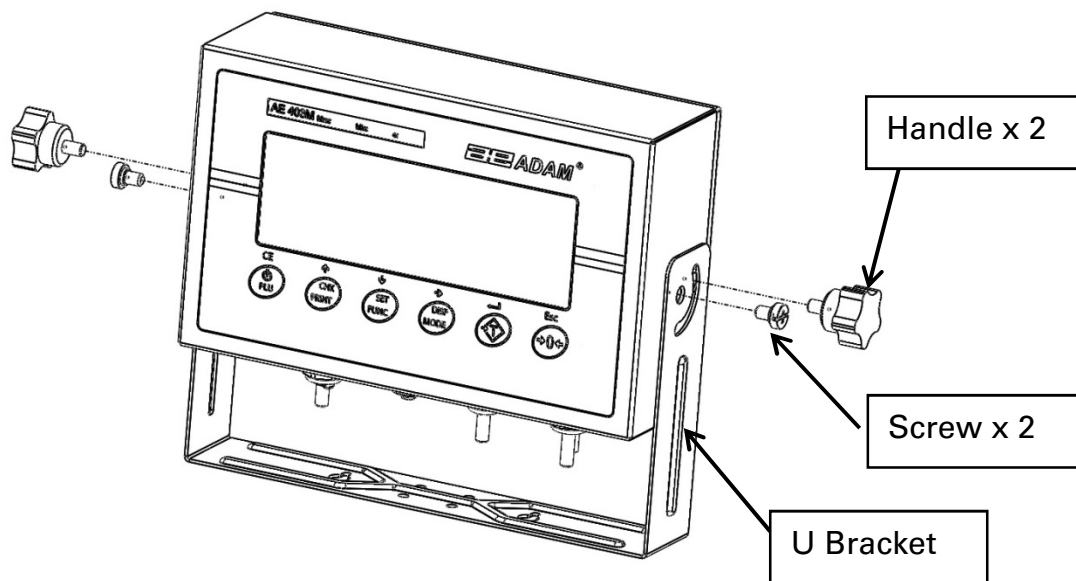

## 10.0 CHANGING LOAD CELL AND RS232 CABLE

Only capable dealers can replace the load cell and RS232 cable for the indicator. You can see detailed steps below. Please make sure external power has been cut off before starting the procedure.

**10.1** According to section 8.2.1, 8.2.2, 8.2.4, take off the PCB, then remove the protection glue for the cable, solder the cable to the PCB board with electric soldering iron and clean the PCB.



LOAD CELL CABLE

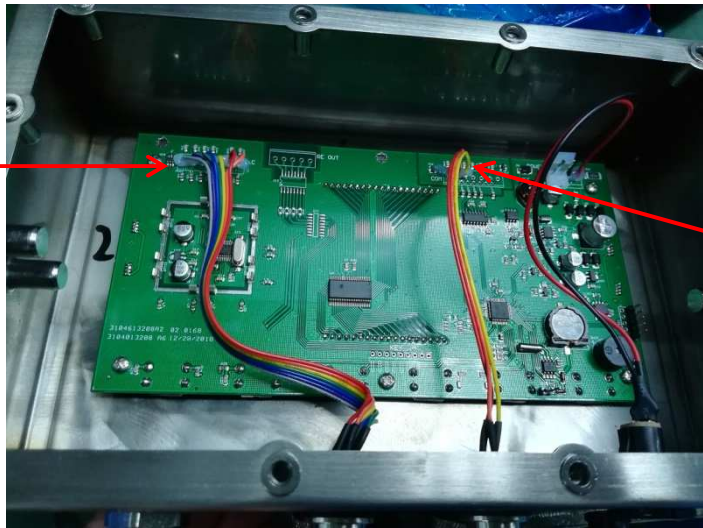

RS232 CABLE

**10.2** Remove the nut with a tool from the cable connector which needs to be replaced for the indicator, so the cable can be taken off.

RS232 CABLE Nut

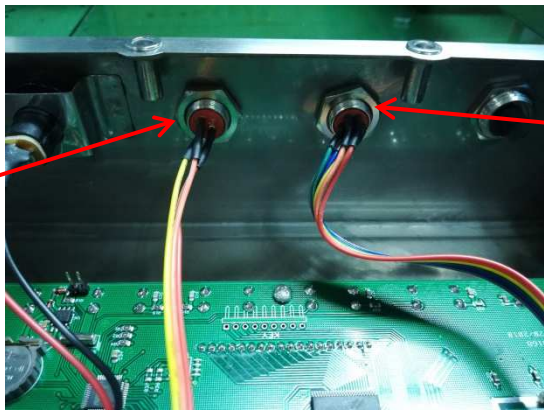

LOAD CELL CABLE Nut

**10.3** Remove the metal cover, go through the new cable to metal cover rubber ring, then connect to corresponding holes on the indicator. Nut can be fit and tightened inside the indicator. Solder the cable on the PCB as required below.

LC 1 2 3 4 5 6 7

RS232 1 2 3

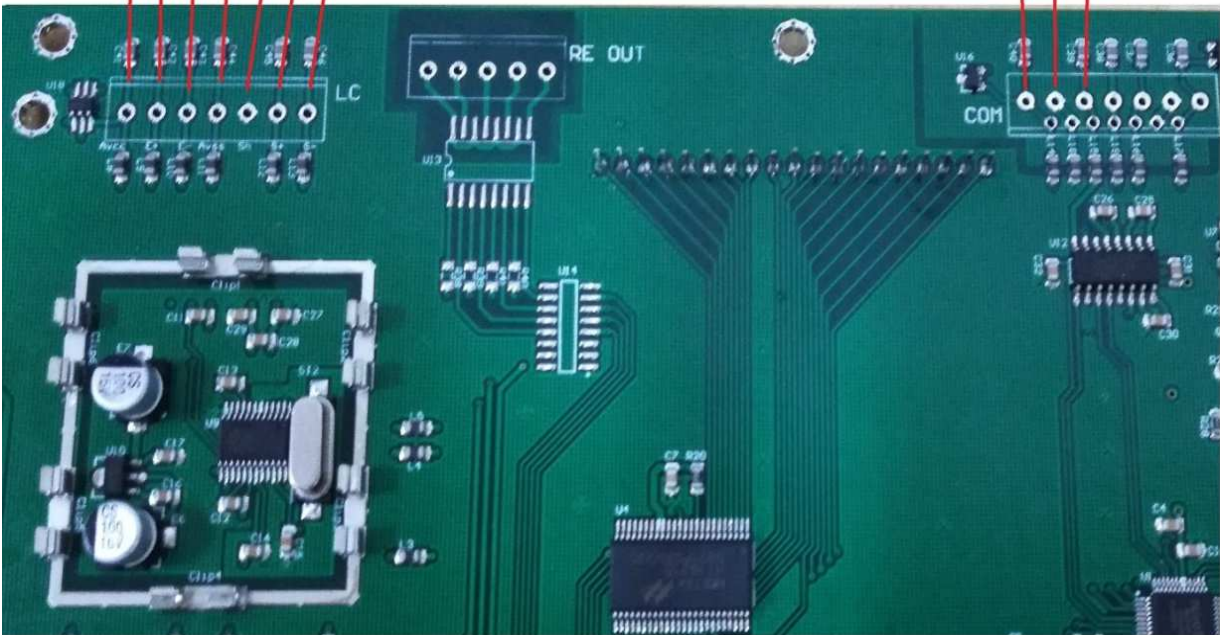

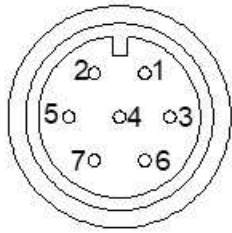

LOAD CELL CABLE  
CONNECTOR

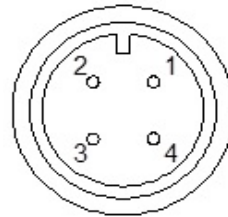

RS232 CABLE  
CONNECTOR

LOAD CELL CABLE CONNECTOR	PCB LC Port
1-----	2
2-----	1
3-----	5
4-----	3
5-----	4
6-----	6
7-----	7

RS232 CABLE CONNECTOR	PCB RS232 Port
1-----	2
2-----	3
3-----	1

**10.4** Put glass cement on the soldering position on the PCB.



**10.5** Follow the steps described in section 11.2.9, fit the rear cover and screw tight the load cell or the metal cover outside RS232 connector, then replace load cell or RS232 cable.



## 11.0 CHANGING BATTERY or BATTERY CABLE

Only capable dealers can replace the internal battery and battery cable for the indicator. You can see detailed steps below. Please make sure external power has been cut off before starting the procedure.

**11.1** Follow the steps described in section 8.2.1, 8.2.2 and open the rear cover of the indicator.

**11.1.1** Unplug the cable from the battery, plug the new battery cable, then insert the battery wire on the PCB board, now battery cable replacement completes.

**11.1.2** Remove the battery trim strip, take out the battery and unplug battery wire.

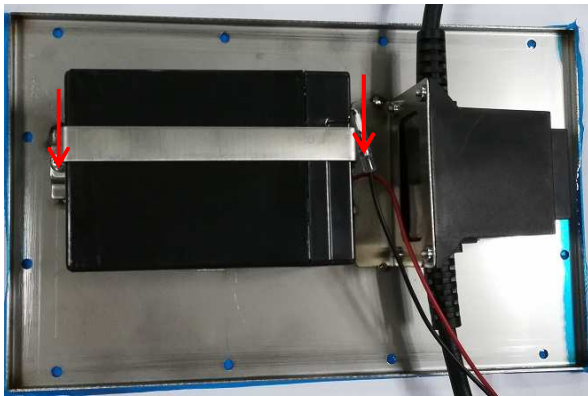

Remove two screws as the red arrow shows, remove the battery trim strip and take out the battery, then unplug the battery wire.  
Note: there is tape between battery and rear cover

**11.2** Connect the battery wire to the new battery, black wire to the black terminal, red wire to the red terminal. Put a 3mm double faced adhesive tape on the battery first, then put and fix the battery to the rear cover and connect battery wire to the PCB.

**11.3** Follow section 8.2.9, fit the rear cover, now battery and battery wire replacement completes.

## 12.0 CHANGING TRANSFORMER

Only capable dealers can replace the transformer for the indicator. You can see detailed steps below. *Please make sure external power has been cut off before starting the procedure.*

**12.1** According to section 8.2.1, 8.2.2, 8.2.4, take off the PCB, then remove the protection glue for the transformer cable on PCB, solder the cable to the PCB board with electric soldering iron and clean the PCB.

**12.2** Screw out 4 fixing screws for the transformer as the red arrow shows and remove the transformer. To make it convenient for placement, you can cut off the transformer wire pointed by yellow arrow.

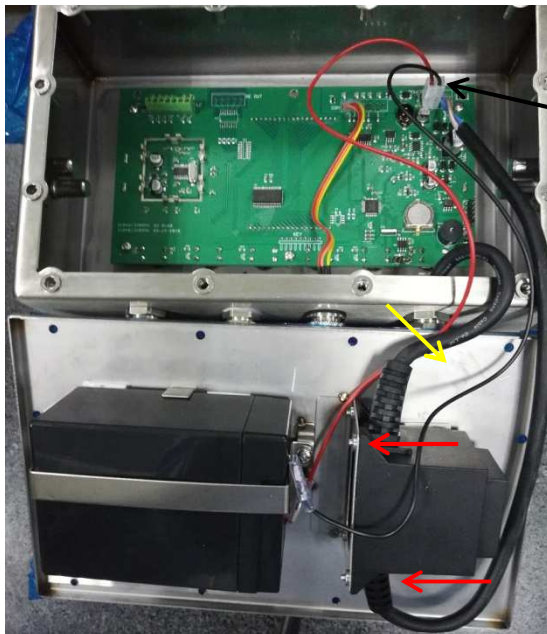

Unplug battery wire, solder the transformer

Remove 4 transformer fixing screws as the red arrow shows and take out the transformer.  
To make it convenient for placement, you can cut off the transformer wire pointed by yellow arrow.  
Note: there is tape between battery and rear cover

**12.3** Screw out the last nut from power interference, take out the transformer. Go through the longer end of the new transformer wire from the indicator internally to the interface hole externally.



Transformer wire goes through rear rubber cap, see the picture for nut order



**12.4** Fit the 4 screws which are removed from the transformer to the rear cover, then solder the other end of transformer wire on the PCB and put glass cement.

**12.5** Reserve proper transformer wire length inside the indicator, screw the nut outside the indicator case tight.



Fit the nut and screw it tight. When the connector attaching the case starts turning, stop putting forth.

**12.6** As described in section 8.2.9, fit the rear cover. Then connect the power plug and transformer wire, now transformer replacement completes. You can see the picture for a finished Euro power connector.



## 13.0 CHANGING OVERLAY

AE 403 indicator overlay replacement is very simple, user can replace it following the steps below.

13.1 Put the indicator upward on a desk and remove the overlay. Remove the model label, clean the overlay surface with ethyl alcohol, and make sure it is clean enough.

13.2 Put the model label on the smaller window on the new overlay, then remove the backing paster for the new overlay, align the overlay and stick it on the indicator and press it flat with hand, now overlay replacement completes.

13.3 Note: new overlay needs 24 hours to become adhesive and be ready for using.

## 14.0 ACCESSORIES & SPARE PARTS

(Available from your accessories supplier)

ADAM can provide the following accessories for replacement:

NO.	Part No.	Description
1	31056 13110	AE 403 Overlay
2	302405088	BATTERY
3	31048 13208	AE 403 Main PCB Assembly, Finished
4	3.02.4.0.8345	BATTERY CABLE ASSY
5	31040 10679	AE402 3 core cable for RS 232 Connections Internal
6	31040 14214	AC/AC Transformer, IP68, 200-240VAC
7	31040 10678	AE402 7 core cable for load cell connections Internal
8	3034014436	AUS Plug (10A 220V)
9	3104014811	EURO to UK plug
10	3034014438	Euro Plug (10-16A 230VAC)
11	30340 13767	Main adaptor
12	3.03.4.0.13768	Power plug, American
13	3.03.4.0.13772	Power plug, Euro
14	3104010635	7 pin connectors, female
15	3104010633	4 pin connectors, female
16	31020 14653	AE 403 in use cover
17		Adam DU Data Collection Program

## WEEE 2012/19/EU

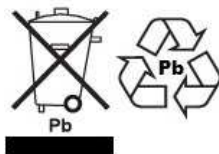

This device may not be disposed of in domestic waste. This also applies to countries outside the EU, per their specific requirements. Disposal of batteries (if fitted) must conform to local laws and restrictions.

Cet appareil ne peut être éliminé avec les déchets ménagers. L'élimination de la batterie doit être effectuée conformément aux lois et restrictions locales.

Dieses Gerät nicht mit dem Hausmüll entsorgt.

Dispositivo no puede ser desechado junto con los residuos domésticos

Dispositivo non può essere smaltito nei rifiuti domestici.

### FCC / IC CLASS A DIGITAL DEVICE EMC VERIFICATION STATEMENT

NOTE: This equipment has been tested and found to comply with the limits for a Class A digital device, pursuant to Part 15 of the FCC rules and Canadian ICES-003/NMB-003 regulation. These limits are designed to provide reasonable protection against harmful interference when the equipment is operated in a commercial environment. This equipment generates, uses and can radiate radio frequency energy and, if not installed and used in accordance with the instruction manual, may cause harmful interference to radio communications. Operation of this equipment in a residential area is likely to cause harmful interference in which case the user will be required to correct the interference at his own expense.

### CALIFORNIA PROPOSITION 65 - MANDATORY STATEMENT

WARNING: This product includes a sealed lead-acid battery which contains chemicals known to the State of California to cause cancer and birth defects or other reproductive harm.



Adam Equipment products have been tested with, and are always supplied with mains power adaptors which meet all legal requirements for the intended country or region of operation, including electrical safety, interference and energy efficiency. As we often update adaptor products to meet changing legislation it is not possible to refer to the exact model in this manual. Please contact us if you need specifications or safety information for your particular item. Do not attempt to connect or use an adaptor not supplied by us.

**ADAM EQUIPMENT** is an ISO 9001:20015 certified global company with more than 40 years' experience in the production and sale of electronic weighing equipment.

Adam products are predominantly designed for the Laboratory, Educational, Health and Fitness, Retail and Industrial Segments. The product range can be described as follows:

- Analytical and Precision Laboratory Balances
- Compact and Portable Balances
- High Capacity Balances
- Moisture analysers / balances
- Mechanical Scales
- Counting Scales
- Digital Weighing/Check-weighing Scales
- High performance Platform Scales
- Crane scales
- Mechanical and Digital Electronic Health and Fitness Scales
- Retail Scales for Price computing

For a complete listing of all Adam products visit our website at  
[www.adamequipment.com](http://www.adamequipment.com)

<p><b>Adam Equipment Co. Ltd.</b>  Maidstone Road, Kingston  Milton Keynes  MK10 0BD  UK  Phone:+44 (0)1908 274545  Fax: +44 (0)1908 641339  e-mail:  <a href="mailto:sales@adamequipment.co.uk">sales@adamequipment.co.uk</a></p>	<p><b>Adam Equipment Inc.</b>  1, Fox Hollow Rd.,  Oxford,  CT 06478  USA  Phone: +1 203 790 4774  Fax: +1 203 792 3406  e-mail:  <a href="mailto:sales@adamequipment.com">sales@adamequipment.com</a></p>	<p><b>AE Adam GmbH.</b>  Instenkamp 4  D-24242 Felde   Germany  Phone +49 (0)4340 40300 0  Fax: +49 (0)4340 40300 20  e-mail:  <a href="mailto:vertrieb@eadam.de">vertrieb@eadam.de</a></p>
<p><b>Adam Equipment S.A. (Pty) Ltd.</b>  7 Megawatt Road,  Spartan EXT 22  Kempton Park,  Johannesburg,  Republic of South Africa   Phone +27 (0)11 974 9745  Fax: +27 (0)11 392 2587  e-mail:  <a href="mailto:sales@adamequipment.co.za">sales@adamequipment.co.za</a></p>	<p><b>Adam Equipment (S.E. ASIA) PTY Ltd</b>  70 Miguel Road  Bibra Lake  Perth  WA 6163  Western Australia  Phone: +61 (0) 8 6461 6236  Fax +61 (0) 8 9456 4462  e-mail:  <a href="mailto:sales@adamequipment.com.au">sales@adamequipment.com.au</a></p>	<p><b>Adam Equipment (Wuhan) Co. Ltd.</b>  A Building East Jianhua  Private Industrial Park  Zhuanyang Avenue  Wuhan Economic &amp; Technological  Development Zone  430056 Wuhan  P.R.China  Phone: + 86 (27) 59420391  Fax + 86 (27) 59420388  e-mail:  <a href="mailto:info@adamequipment.com.cn">info@adamequipment.com.cn</a></p>

© Copyright by Adam Equipment Co. All rights reserved. No part of this publication may be reprinted or translated in any form or by any means without the prior permission of Adam Equipment.

Adam Equipment reserves the right to make changes to the technology, features, specifications and design of the equipment without notice.

All information contained within this publication is to the best of our knowledge timely, complete and accurate when issued. However, we are not responsible for misinterpretations which may result from the reading of this material.

The latest version of this publication can be found on our Website. [www.adamequipment.com](http://www.adamequipment.com)