

iJack - 26

(2,600 LBS. Capacity)

RAVAS
creating intelligence



Owner's Manual

www.ravas.com

RAVAS

PLEASE RETAIN THESE INSTRUCTIONS FOR FUTURE REFERENCE

If you have any queries concerning the duration and terms of the guarantee, please contact your supplier. We would also refer you to our General Sale and Supply Conditions, which are available on request.

The manufacturer accepts no liability for any damage or injury caused by failure to follow these instructions or from negligent operation or assembly, even if this is not expressly stated in this instruction manual. In light of our policy of continuous improvement, it is possible that details of the product may differ from those described in this manual. For this reason, these instructions should only be treated as guidelines for the installation of the relevant product. This manual has been compiled with all due care, but the manufacturer cannot be held responsible for any consequences of errors. All rights are reserved and no part of this manual may be reproduced in any way.

We would like to inform you about the fact that this RAVAS product is 100% recyclable on the basis that the parts are processed and disposed of in the right manner.

More information can be found on our website: www.ravas.com



**OPERATION MANUAL
IJACK-26**

INDEX	PAGE
1. iJack-26 Features	4
2. iJack-26 Specs	5
3. Safety Instructions	7
4. The Weighing Electric Pallet Truck	8
5. 320 Indicator	10
6. Indicator Functions	11
7. Indicator Calibration	13
8. Touch Panel Indicator	19
9. Printer (Option)	21
10. Relay (Option)	22
11. Trouble Shooting	26
12. Parameter Settings	30

Contact Us:

**RAVAS USA, INC.
1500 Enterprise Parkway
Twinsburg, OH 44087**

Phone Number: +1 (33) 425-3092

salesoffice-usa@ravas.com

www.ravas.com

▣ iJack-26 FEATURES

■ Light Service Weight, Decent Capacity, Suitable for anywhere a Hand Pallet Truck Could Be Used:

- 264.55 lbs. Ultra-light Service Weight
- 2,645.55 Highly Rated Capacity
- Come and Go Freely in Small Working Space Environments with 54 inch Turning Radius

■ CAN-BUS System:

CAN-BUS System Simplifies Operation/ Maintenance Level, Improves System Reliability

■ Integrated Design:

Innovative Designed Sealed Hydraulic Unit, Low Noise, Easy Maintenance

■ Non-Contact Limit Switch Design:

New Non-Contact Limit Switch Design Improves the Reliability

■ Safety:

Convenient Emergency Stop Switch, Strong Driving Wheel Cover, Solid Battery Clip, Ensure Safety and Reliability

■ Battery:

12.78 lbs. Battery Replacement, Optional Standby Battery Extend Run Time

■ Integrated Handle Design:

New Design of Integral Handle Head, Easy to Access All Control Buttons

■ Robust Frame Design:

New Frame Design, Light Service Weight, High Strength

■ Innovative Key Switch Design:

The Key Switch Design is Integrated with U-Disk Function

■ Easy Maintenance:

Maintenance Free Truck Design for End Users to Trouble Shooting and Replace Failure Part by Simple Instruction, Free Labor Cost.

SMART Panel Reflect Operation and Trouble Shooting Status



SPECS - iJack 26

Distinguishing Mark				
1.1	Manufacturer			RAVAS
1.2	Model Designation			iJack 26
1.3	Power Unit			Battery
1.4	Operator Type			Pedestrian
1.5	Load Capacity	Q	Lbs.	2,645.55
1.6	Load Center	C	In.	23.62
1.7	Axle Center to Fork Face	X	In.	37.40 (34.65)
1.8	Wheelbase	Y	In.	46.85 (44.10)
Weights				
2.1	Service Weight (Include Battery)		Lbs.	268.60
2.2	Axle Loading with Load, Driving Side/Loading Side		Lbs.	925.94/2006.21
2.3	Axle Loading Without Load, Driving Side/Loading Side		Lbs.	242.51/44.09
Wheels/Tires				
3.1	Tire Type Driving Wheels/Loading Wheels			PU/PU
3.2	Tire Size, Driving Wheels (Diameter X Width)		In.	8.27 X 2.76
3.3	Tire Size, Loading Wheels (Diameter X Width)		In.	3.15 X 2.36 (2.91 X 3.46)
3.4	Wheels, Number Driving/Loading (X=Drive Wheels)		In.	.04 X 0.16 (0.04 X 0.10)
Dimensions				
4.1	Lift Height	H3	In.	4.53
4.2	Height of Tiller Arm in Driving Position, Min./Max.	H14	In.	29.53/ 46.85
4.3	Fork Height, Lowered	H13	In.	3.15
4.4	Overall Length	L1	In.	60.63
4.5	Length to Fork Face	L2	In.	15.35
4.6	Overall Width	B1	In.	22.05 (26.97)
4.7	Fork Dimensions	SXEXL	In.	2.48 X 5.91 X 45.28
4.8	Outside Width of the Forks	B5	In.	22.05 (26.97)
4.9	Ground Clearance, Center of Wheelbase	M2	In.	1.06
4.10	Aisle Width for Pallets 1000 X 1200 Crossways	AST	In.	64.57
4.11	Aisle Width for Pallets 800 X 1200 Lengthways	AST	In.	72.44
4.12	Turning Radius	Wa	In.	54.72
Performance				
5.1	Travel Speed, with/without Load		Mph	2/2.5
5.2	Lifting Speed, with/without Load		Ft/s	0.07/0.082
5.3	Lowering Speed, with/without Load		Ft/s	0.30/0.16
5.4	Max. Gradeability, with/without Load		%	4/10
5.5	Service Brake			Electric
Drive				
6.1	Drive Motor Rating 60 Min		W/s	650
6.2	Lift Motor Rating at 15%		W/s	500
6.3	Battery Type			Li-ion
6.4	Battery Voltage/Rated Capacity (5H)		V/Ah	24.20
6.5	Battery Weight		Lbs.	12.79
6.6	Power Consumption According to VDI Cycle		W/hr	0.25
6.7	Charger			24V10A
6.8	Optional Battery Pack Capacity			24V 26Ah
Others				
7.1	Type of Drive Control			DC
7.2	Noise at the Driver's Ear			<74
7.3	Application			GENERAL

If there are improvements of technical parameters or configurations, no further notice will be given.
The diagram shown may contain non-standard configurations.

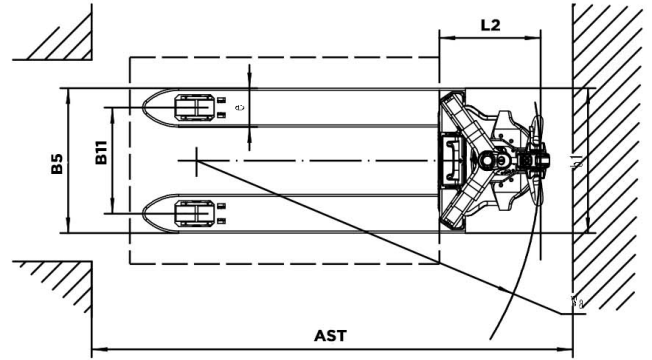
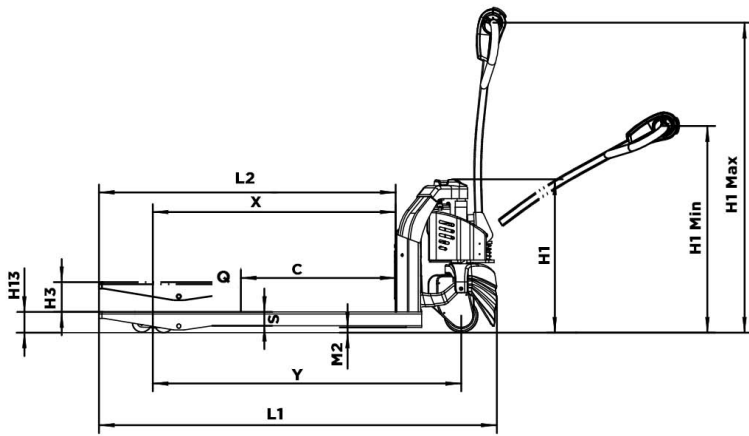

Safety Instructions

1. All safety regulations that apply on the electric pallet truck remain valid and unchanged.
2. No weighing operation is allowed while others are on or near the load.
3. No weighing operations allowed if any objects are in the vicinity; around, or close to the load
4. RAVAS is not responsible for physical harm done to the operator because of the presence of the indicator.
5. Any modifications done to the system must be approved in writing from the supplier, prior to any work being completed.
6. It is the sole responsibility of the purchaser to train their own employees in the proper use and maintenance of this equipment.
7. Do not operate this unit unless you have been fully trained of its capabilities.
8. Do not use the weighing system in potentially explosive areas.
9. Do not weld to the lift truck without disconnecting the pressure sensor.
10. Check the accuracy of the scale on a regular basis to prevent faulty readings.
11. Only trained and authorized personnel are allowed to operate the scale.
12. Always follow the operating, maintenance and repair instructions of this truck and ask the supplier when in doubt.
13. Never lower loads if you are unsure you can place the goods on a stable surface. Personal injury may result from placement on an unstable environment.
14. RAVAS is not responsible for errors that occur due to incorrect weighings or inaccurate scales.

↙ The Weighing Electric Pallet Truck

TAKING THE SYSTEM INTO OPERATION

The power supply to the weighing system takes place through the battery of the electric pallet truck.

To activate the system, turn it on using the on/off (ⓐ) key on the indicator.

It is recommended not to lift loads before the zero point correction has been executed. (See page 13)

Accurate Weighing

The weight must be centered over the forks of the pallet truck and be able to lift freely: without touching the electric pallet truck or other pallets. The wheels of the electric pallet truck must not be touching the pallet or any other part of the load.

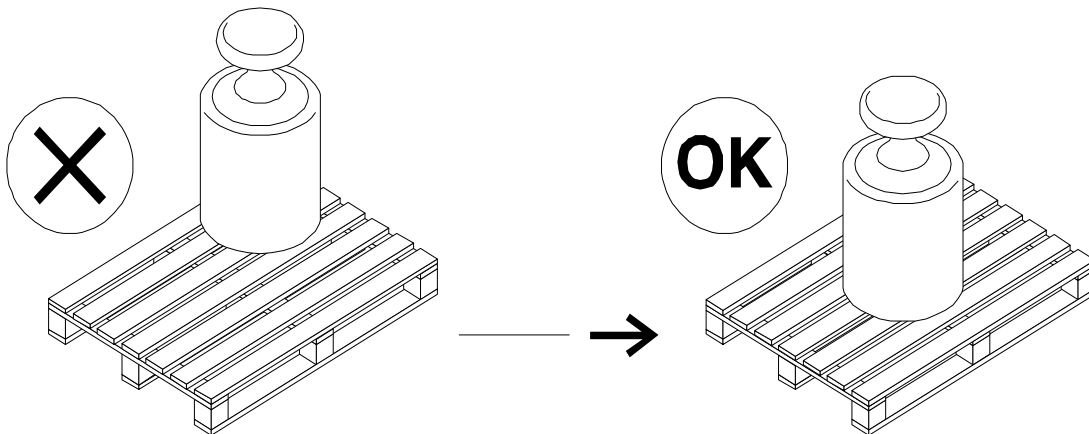

The iJack comes equipped with a level switch. This means that when the system is tilted by greater than 2° the indicator will automatically shut off. An uneven floor will have a greater effect on weighing ability. An even floor is optimal.

The most accurate weighing result is obtained when the center of gravity of the load is placed evenly between the forks.

TEMPERATURE

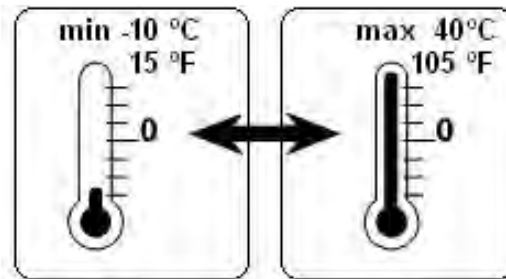

Temperature range: between 15 – 105 °F (-10 - +40 °C) the maximum inaccuracy is 0.1% of the weighed load. Outside this range inaccuracies of up to 0.3% may occur.

Fast temperature changes must be avoided because it can cause condensation in the electronics. During acclimatization the weighing system must be shut off.

MAINTENANCE

The maintenance guidelines for normal electric pallet trucks apply to the chassis of the mobile weighing system. The integrated weighing system still functions even when the chassis is damaged by overloading. Care should be taken to prevent damage to the load cells.

Main guidelines:

- Clean only with a damp cloth. Chemical cleaners and high pressure washers will cause damage to the system. System should be cleaned regularly to remove any accumulating dirt between the parts of the system.
- Check bolts regularly. When used roughly, they may loosen.
- The weighing system meets up to the protection class IP65. This means that dust or moisture (rain or water beam from all sides), will not influence the operation of the electronics. However, high-pressure cleansing in combination with warm water or chemical cleansers will lead to the entry of moisture and therefore negatively influence the operation of the system.
- Only specialists may perform any welding. This is to avoid damage to electronics and load cells.

320 Indicator



BENEFITS

- Code entry, lb/kg toggle
- Relay for automatic dosing
- Display with backlight
- Internal clock for date/time
- For warehousing, dosing and mixing
- Bluetooth 4.0 for RAVAS WeightsApp

Top quality

Advanced functions

FUNCTIONS

- Automatic and manual zero correction
- Gross/net weighing
- Automatic tare by push button
- Tare entry by cursor function
- Totaling with sequence number
- Code entry for max. 5-digit codes, by cursor function
- Three data output modes: print, continuous and command/answer
- lb or kg toggle
- Internal clock (for recording date/time on printout)
- Error messages in display
- Power supply to printer switched on and off by indicator
- Automatic shut-off function, defined by parameter setting
- Low battery indication
- Bluetooth 4.0 for RAVAS WeightsApp

STANDARD SPECIFICATIONS

- | | |
|---------------------|-------------------------------------------------------------------------|
| ▪ Display | digital |
| ▪ Segments | LCD, digit height 0.79 inch, backlight, dual color |
| ▪ Graduation | 0.2, 0.5, 1, 2, 5, 10, 20 or 50 lb (see specifications weighing system) |
| ▪ Housing | plastic (ABS) |
| ▪ Bracket | steel |
| ▪ Colour | red (RAL 3000) |
| ▪ Protection class | NEMA 4 / IP65 |
| ▪ Power supply | 12V (230V for stationary applications) |
| ▪ Power consumption | 35 mA |
| ▪ Dimensions | exc. bracket: 2.4 x 3 x 7.2 inch |





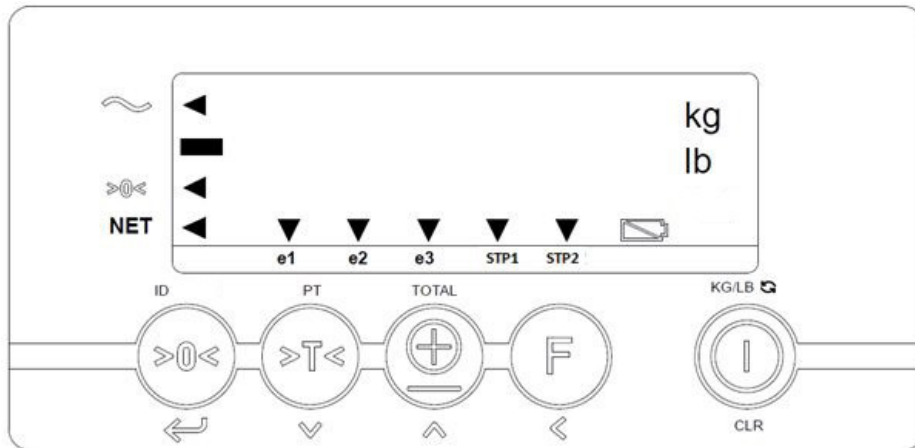



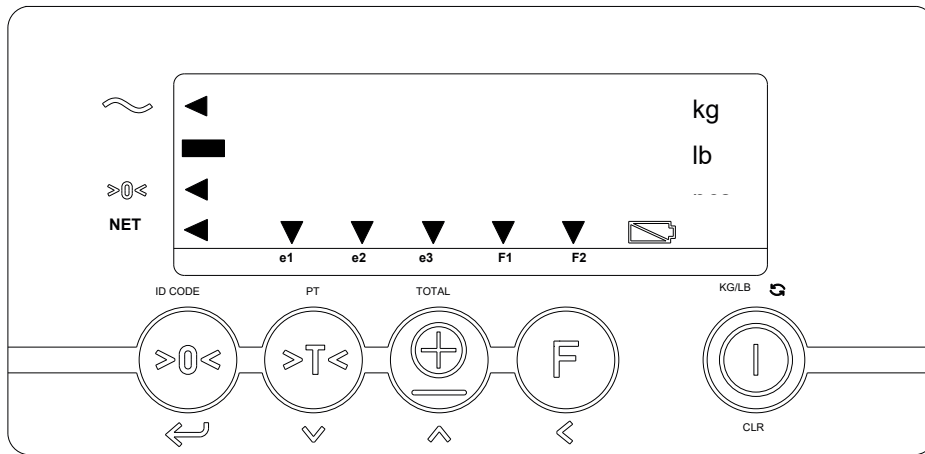

320 Indicator Functions

Indicator 320



Indicator 320-BLE



-   the weighing system (including load) is stable
-  the weight shown is negative
- ZERO**  the weight shown is within the zero range
- NET**  the display is showing the net weight
- e1**  displayed weight is in range 1 (option multi range)
- e2**  displayed weight is in range 2 (option multi range)
- e3**  displayed weight is in range 3 (option multi range)
- stp/F1**  setpoint 1 active (option function key activated)
- stp/F2**  setpoint 2 active (option function key activated)
- kg** displayed weight is in kilograms
- lb** displayed weight is in pounds
-  low bat indicator

Key functions

Each key has 2 operational and one entry function.

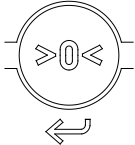
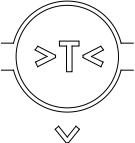
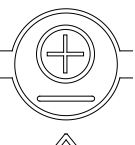
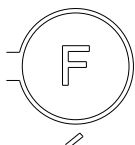
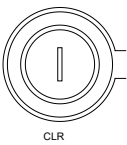
Standard function (short key press)	Key	Special function (long key press)	Value entering function (entry mode)
Zero setting	<p>ID CODE</p> 	code entry	enter
automatic tare	<p>PT</p> 	pre-set tare	decrease the value of the digit flashing
print weight and add to the total	<p>TOTAL</p> 	check subtotal and print/reset total	increase the value of the digit flashing
start special function if active		no function	shift to the next digit on the left
On switch And change to lb and kg	<p>KG/LB</p>  <p>CLR</p>	Off switch	clear entry

Important

Operation of a key is not accepted unless the weighing system is stable (and the “load stable” pointer lights up). This means that the indicator only executes commands with a stable load.

320 Indicator Calibration

Net / Tare / Gross weight

EXPLANATION: $Net(1) + Tare(2) = Gross(3)$

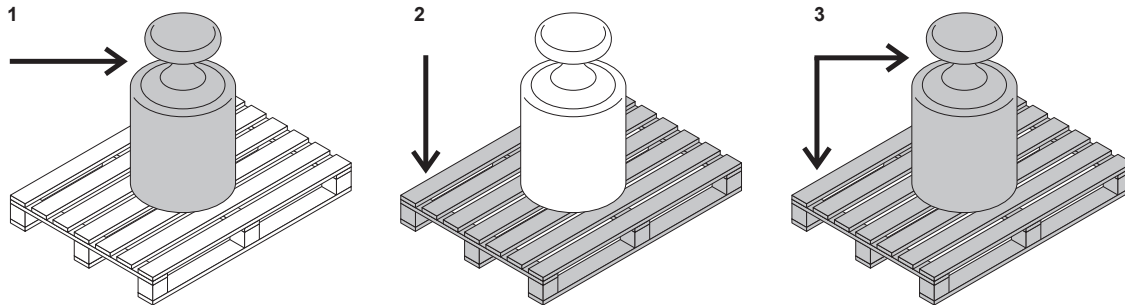

Net weighing: automatic tare

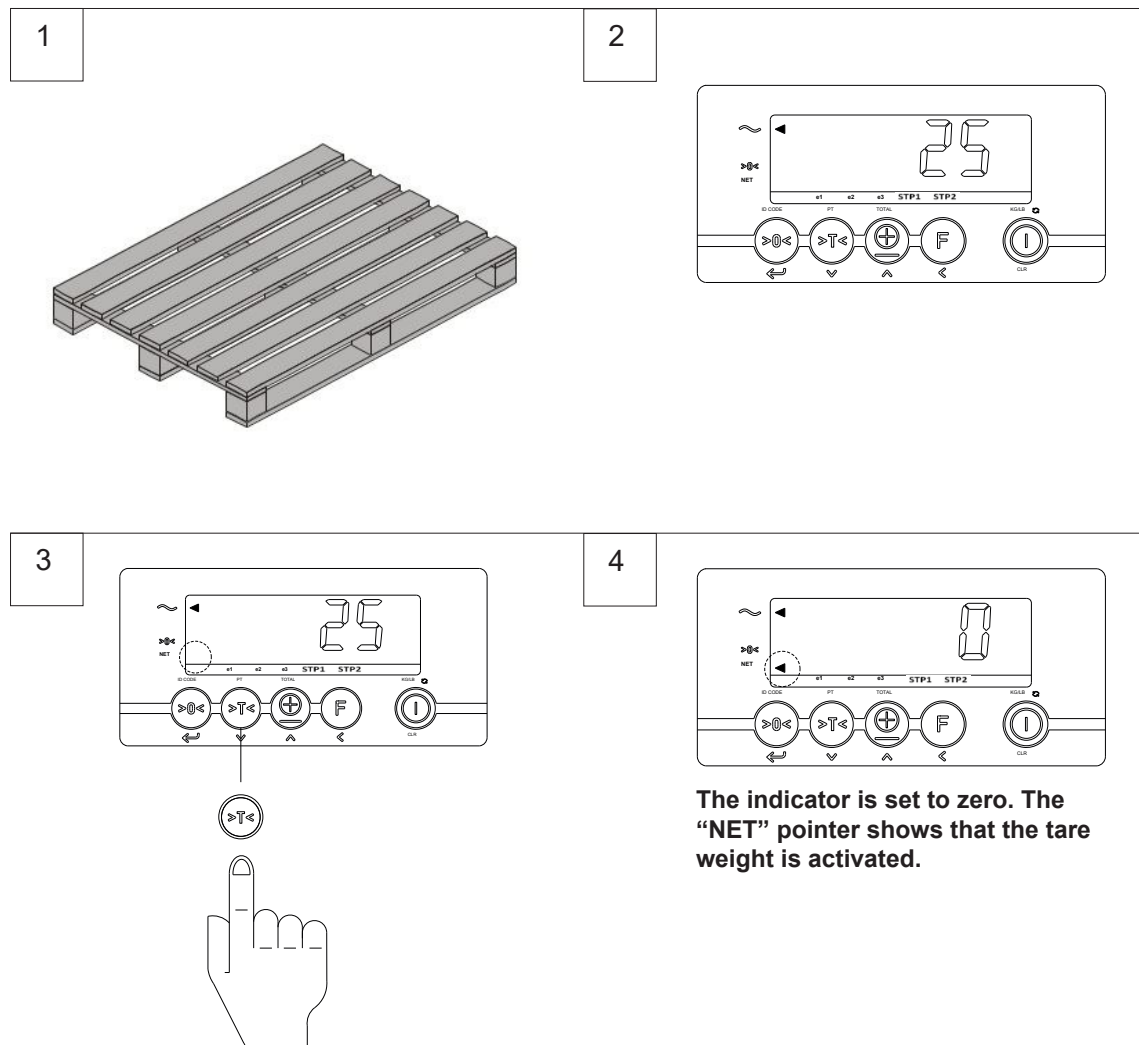

5

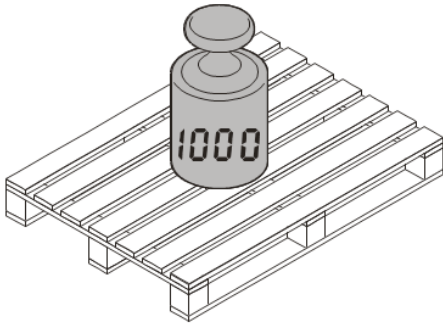

6

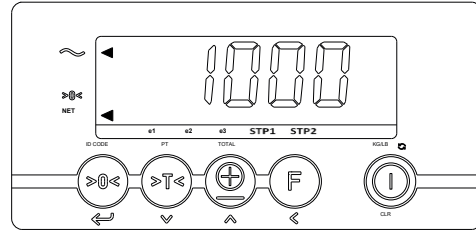

The display shows the net value of the weighed load.

7

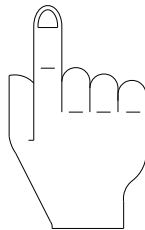
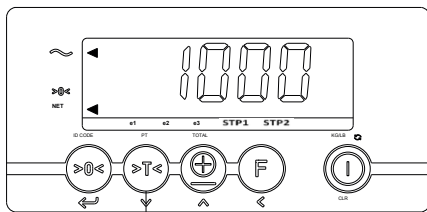

8

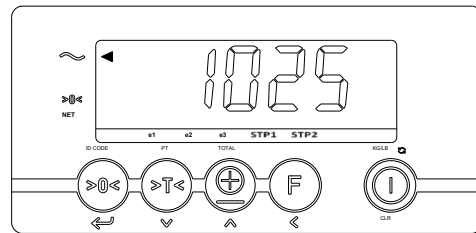

The gross weight is displayed again.

9

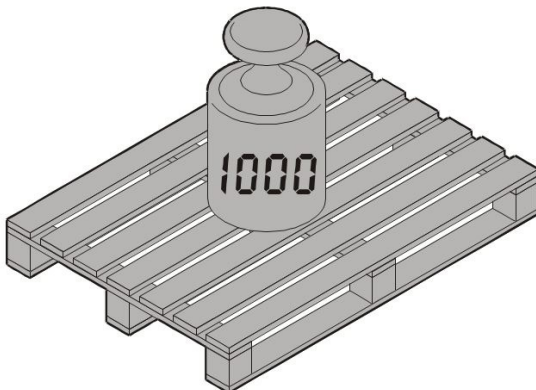

NOTE: for OIML approved RAVAS 320 the tare will be erased automatically when the weight returns to gross zero! For the next weighing the tare must be activated again.

Net weighing: manual tare (PT)

1

2

3 sec.

Press the
>T< key for 3 seconds.

3

5x

Press the up or down key until the desired value is reached.

4

1x

5

2x

Press the up or down key until the desired value is reached.

6

Press ENTER to activate the tare weight.

7

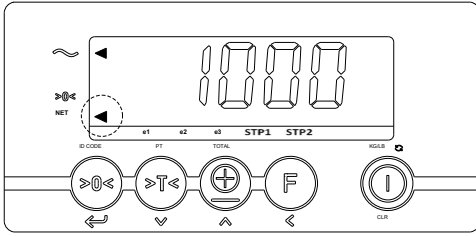

The "NET" pointer lights up.

8

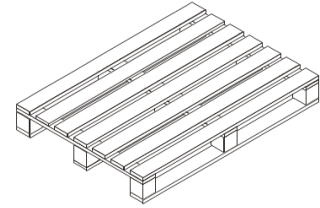

9

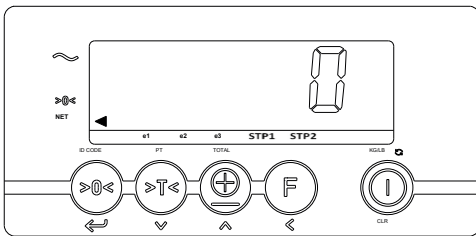

10

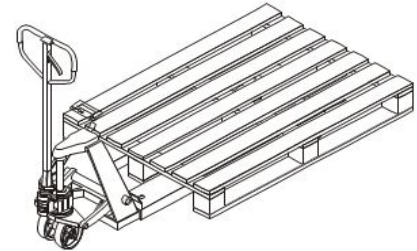

11

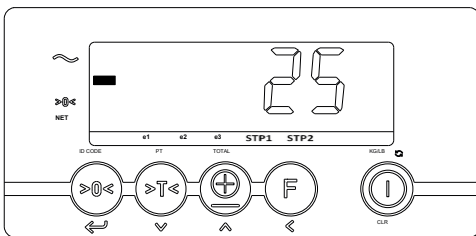

When the pallet wagon is completely unloaded, the tare value is displayed negatively.

12

NOTE: for OIML approved RAVAS 320 the tare will be erased automatically when the weight returns to gross zero! For the next weighing the tare must be activated again.

Press >T< and then Enter only when tare value is the same.

Adding & reset

1

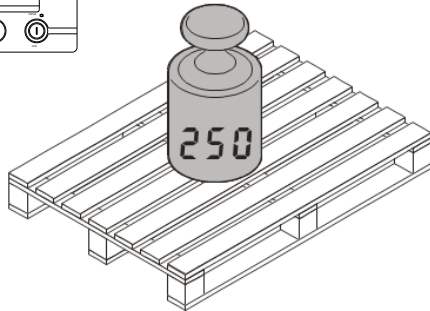
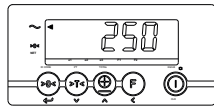

2

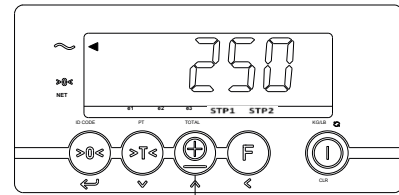

Press the **TOTAL** key to add the weight load to the total weight.

If a printer is installed, a printout will be made. The gross, net and tare weights are printed.

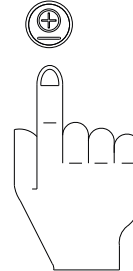

3

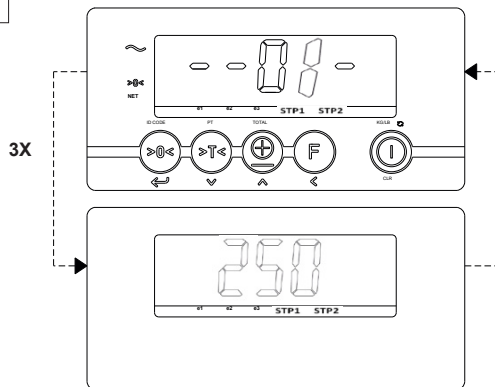

4

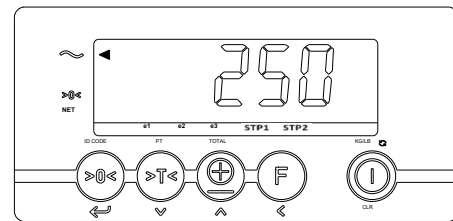

The display returns to the weighing mode automatically.

5

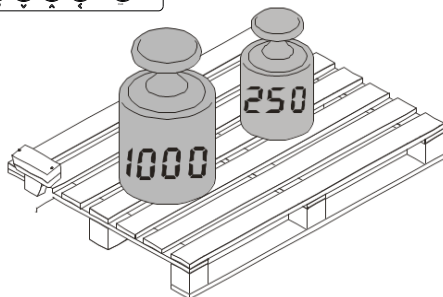
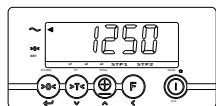

6

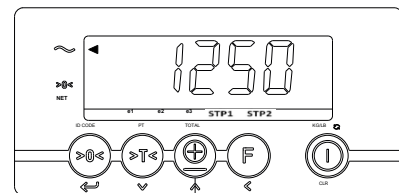

Press the **TOTAL** key to add the load weight to the total weight.

If a printer is installed, a printout will be made. The gross, net and tare weights are printed.

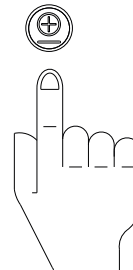

7

3X

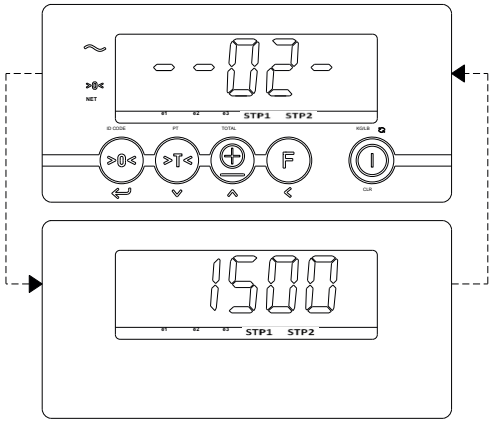

8

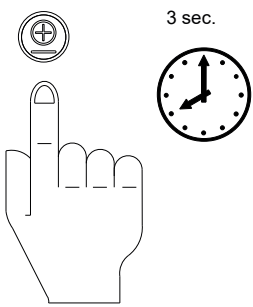
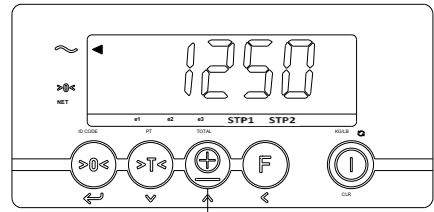

The subtotal
can be checked
by pressing the
TOTAL key for
3 sec.

9

3 sec.

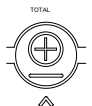
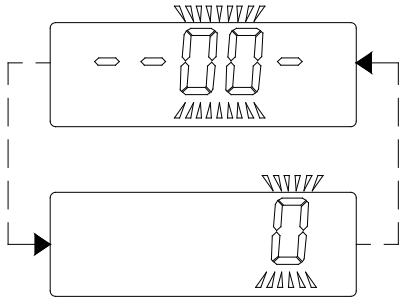
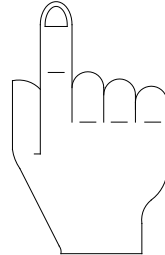
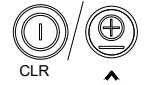
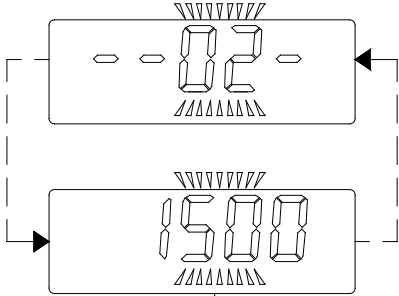
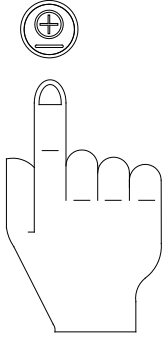

= RESET TOTAL & PRINT

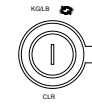

= RESET TOTAL

NOTE: In case the total is not manually used or reset, the system will do this automatically as soon as the total number has reached 99 or as soon as the total weight has reached a value of 99999 kg.

3. TOUCH PANEL INDICATOR

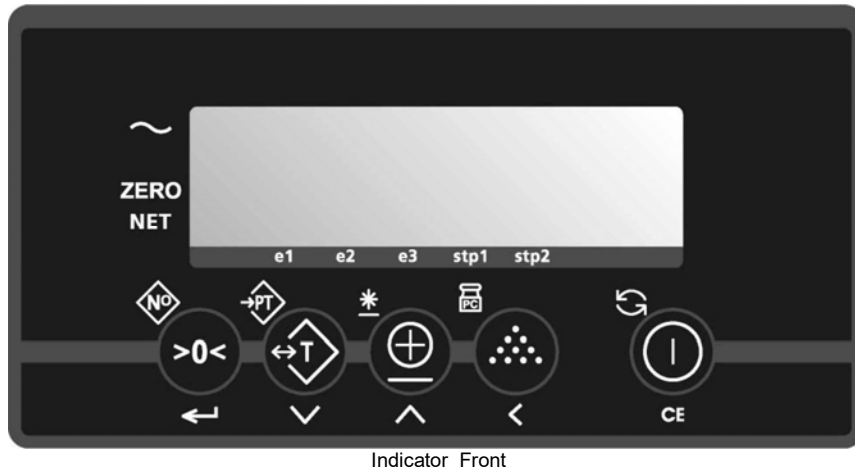



There are 3 display-modes.

The display may show the weight in kgs, lbs or it shows the number of pieces. Also the battery sign is integrated in the display in order to show low battery status.





THE DISPLAY

By means of eight pointer bars the display shows:

-  ◀ the weighing system (including load) is stable
-  the weight shown is negative
- ZERO** ◀ the weight shown is within the zero range
- NET** ◀ the display is showing the net weight
- e1** ▼ displayed weight is in range 1
- e2** ▼ displayed weight is in range 2
- e3** ▼ displayed weight is in range 3
- stp1** ▼ setpoint 1 is activated
- stp2** ▼ setpoint 2 is activated

THE TOUCH PANEL

Each key has 2 operational and one entry function

Key	Function level 1 (short key press)	Function level 2 (long key press)	Function level 3 (entry mode)
	zero setting	code entry	enter
	automatic tare	pre-set tare	decrease the value of the digit flashing
	print weight and add to the total	check subtotal and print total	increase the value of the digit flashing
	sampling a piece weight	enter a piece weight	shift to the next digit on the left
	on/off switch	toggle units	clear entry

IMPORTANT

Operation of a key is not accepted unless the weighing system is stable (and the “load stable” pointer lights up). This means that the indicator only executes commands with a stable load.

WARNING

When the weighed load surpasses the pre-set maximum, the display shows: “ERR02”. In order to prevent damage to the indicator or load cells, the weighing system must be unloaded immediately.

Printer (Option)

If the weighing system has been equipped with a printer, obtained and entered weighing data can be printed. Date and time are only printed out with the option board installed.

In the printout a gross weight is indicated with the letters "B/G" and a net weight with the letter "N". A manually entered tare weight will also be printed and is indicated with the letters "T". The total weight is shown with the letters "TOT".

Standard printout without code

B/G	1234.5 kg.
T	34.5 kg.
N	1200.0 kg.
Nr.	1
10/07/03	17:45

Standard printout with code

CODE	12345
B/G	1234.5 kg.
T	34.5 kg.
N	1200.0 kg.
Nr.	1
10/07/03	17:45

Piececount printout without code

B/G	1234.5 kg.
T	34.5 kg.
N	1200.0 kg.
PcWt	1.234 kg.
Qty	12345 PCs
Nr.	1
10/07/03	17:45

Piececount printout with code

CODE	12345
B/G	1234.5 kg
T	34.5 kg
N	1200.0 kg
PcWt	1.234 kg
Qty	12345 PCs
Nr.	1
10/07/03	17:45

Total printout (always without code)

Tot. B/G	1234.5 kg.
Tot. T	34.5 kg.
Tot. N	1200.0 kg.
Tot. Nr.	999
10/07/03	17:45

CHANGE TIME AND DATE ON THE PRINTOUT

If the weighing system has been equipped with a printer, and an option board, the date and time can be printed together with the weight information.

- Press the ⌘ key for 6 seconds.
 - The display will show “ho_00” or the previous hour time setting, with the right digit flashing.
- To accept the old value press ENTER (↵).
- **Or**
- Press the \wedge key to go up a value or press the \vee key to go down a value until the required value is reached.
- Press \lt to change to the next digit and use the \wedge or \vee key to change the value until the required value is reached.
- To accept the new value press ENTER (↵).
 - The display will show “m_00” or the previous minute time setting, with the right digit flashing.
- Repeat the above procedure to accept or change the minute setting.
 - The display will show “dA_00” or the previous date of the month setting, with the right digit flashing.
- Repeat the above procedure to accept or change the date of the month setting.
 - The display will show “m_00” or the previous month setting, with the right digit flashing.
- Repeat the above procedure to accept or change the month setting.
 - The display will show “YE_00” or the previous year setting, with the right digit flashing.
- Repeat the above procedure to accept or change the year setting.
 - The indicator will return to normal weighing mode.

6. RELAY (Option)

If this option is used, it is no longer possible to use the piece-counting mode. The setting of the set-points for the relay is done with the same key as is used for sampling or entering a piece weight.

Relay technical specifications: Type: Zettler AZ833-12DE
 Coil voltage: 12VDC
 Switched capacity: max. 30VDC/2A

The choice of relay application is made when the system is ordered and the program is selected in the parameter menu. The instructions for use depend on the application chosen.

Four different applications are possible; 1 – overload check gross weight
 2 – overload check net weight
 3 – dosing/filling with manual tare & start
 4 – dosing/filling with auto tare & start

In this setting set-point 1 is activated as soon as the gross or net value exceeds the set-point value. In this case the set-point value is an absolute value.

To enter a new value:

- Press the ⏏ key.
 - The display shows the last entered value with the left digit blinking. The pointer for set-point 1 is on.
- Press ↵ to accept the old value.
 - The set-point value is activated and the display returns to the weighing mode.

Or

- Press the ⏏ key.
- Press the ^ key to go up a value or press the v key to go down a value until the required value is reached.
- Press < to change to the next digit.
- Repeat this procedure until the required value is displayed.
- Press ↵ to accept the new value.
 - The set-point value is activated and the display returns to the weighing mode.

DOSING/FILLING with Manual Tare & Start

In this setting set-point 1 and 2 are switched on as soon as the tare key has been activated and after the set-point values have been entered.

To enter new set-point values:

- Press the ⏏ key.
 - The display shows the last entered value with the left digit blinking. The pointer for set-point 1 is on.
- Press ↵ to accept the old value.
 - The value for set-point 1 is activated. The display shows the last entered value for set-point 2 with the left digit blinking. The pointer for set-point 2 is on.

Or

- Press the ⏏ key.
- Press the ^ key to go up a value or press the v key to go down a value until the required value is reached.
- Press < to change to the next digit.
 - Repeat this procedure until the required value is displayed.
- Press ↵ to accept the new value.
 - The set-point value is activated and the display returns to the weighing mode.
 - The display shows "tare".

FILLING:

Place an empty container on the scale.

- Press the ⇄T key.
 - ❑ The display shows the net value and the pointers stp1 and stp2 are on.
 - ❑ Relays 1 and 2 are closed.
 - ❑ As soon as set-point 1 is reached, pointer stp1 will turn off and relay 1 will be opened.
 - ❑ As soon as set-point 2 is reached, pointer stp2 will turn off and relay 2 will be opened.
 - ❑ The display shows “done” for a few seconds and will return in the normal weighing mode.
 - ❑ The net weight is displayed. A printout may be made at this point.

It is possible to cancel the filling procedure at any time by pressing the CE key (see page 18).

DOSING:

Place a full container on the scale.

- Press the ⇄T key.
 - ❑ The display shows the net value and the pointers stp1 and stp2 are on.
 - ❑ Relays 1 and 2 are closed.
 - ❑ As soon as set-point 1 is reached, pointer stp1 will turn off and relay 1 will be opened.
 - ❑ As soon as set-point 2 is reached, pointer stp2 will turn off and relay 2 will be opened.
 - ❑ The display shows “done” for a few seconds and returns in the normal weighing mode.
 - ❑ The net weight is displayed. A printout may be made at this point.

It is possible to cancel the dosing procedure at any time by pressing the CE key (see page 18).

The printout will show the following:

- The gross weight is the weight of the container with rest material.
- The tare weight is the weight of the container with material before dosing.
- The net weight will show a minus sign as token of weight being removed from the scale.

DOSING / FILLING with Automatic Tare & Start

In this setting set-point 1 and 2 are switched on as soon as the set-point values have been entered. The tare action is done automatically in this mode.

To enter new set-point values:

- Press the ⌘ key.
 - ❑ The display shows the last entered value with the left digit blinking. The pointer for set-point 1 is on.
- Press ↵ to accept the old value.
 - ❑ The value for set-point 1 is activated. The display shows the last entered value for set-point 2 with the left digit blinking. The pointer for set-point 2 is on.

Or

- Press the ⌘ key.
- Press the \wedge key to go up a value or press the \vee key to go down a value until the required value is reached.
- Press \leftarrow to change to the next digit.
 - ❑ Repeat this procedure until the required value is displayed.
- Press \downarrow to accept the new value.
 - ❑ The set-point value is activated and the display returns to the weighing mode.
 - ❑ The display shows “tare” and the indicator automatically tares out the scale after the scale has been stable for a few seconds.

⚡Attention: be sure the container is already in place at this moment!

Filling & Dosing:

- ❑ The display shows the net value and the pointers stp1 and stp2 are on.
- ❑ Relays 1 and 2 are closed.
- ❑ As soon as set-point 1 is reached, pointer stp1 will turn off and relay 1 will be opened.
- ❑ As soon as set-point 2 is reached, pointer stp2 will turn off and relay 2 will be opened.
- ❑ The display shows “done” for a few seconds and will return in the normal weighing mode.
- ❑ The net weight is displayed. A printout may be made at this point.

It is possible to cancel the filling or dosing procedure at any time by pressing the CE key (see below).

The printout will show the following:

- The gross weight is the weight of the container with rest material.
- The tare weight is the weight of the container with material before dosing.
- The net weight will show a minus sign as token of weight being removed from the scale.

CANCEL DOSING / FILLING

It is possible to cancel the filling or dosing procedure at any time by pressing the CE key.

- Press the CE key to stop the procedure.
 - ❑ The display shows “stop” and the relays are opened. Pointers stp1 and stp2 will be turned off.
- Press ENTER to start the procedure again.
 - ❑ The display sign “stop” is cleared and the net weight is displayed again. The relays are closed. Pointers stp1 and/or stp2 will be turned on.

Or

- Press the CE key to stop the procedure.
 - ❑ The display shows “done” for a few seconds and will return in the normal weighing mode.
 - ❑ The net weight is displayed.

↓ Troubleshooting

No power	Open indicator and measure power on the board.	Is voltage coming from the truck battery?	Check where the power line comes from. See if power is available on this point. Mostly a fuse is installed. Measure is voltage is also available after the fuse. If power is available in the indicator then check if the power board is not functioning.
		If the power from the truck is more than 12 Vdc, then the first board is a power converter board.	Check if red and black wire connected between the power board and the main board has 12 Vdc. If there is no 12Vdc coming out of this board check this board. If nothing can be found it needs to be replaced. If 12Vdc is supplied to the main board. Then check the main board.
	12Vdc on the board	Check the board for burned components	Picture of component most likely to blow when batteries have been entered the wrong way.
	Accuracy	No repeatability	Check if there is a mechanical problem.
	Check the load cells. If one is broken or gives more or less signal than the others, the scale will give different reading depending how it is loaded.	Check the load cells. If one is broken or gives more or less signal than the others, the scale will give different reading depending how it is loaded.	<p>To be sure that it is not a mechanical problem, load the load cells directly. Take off the fork cover. Try to apply weight 25 to 50 kg / lb, direct onto each load cell. If the indicator shows the same reading, the load cells are OK.</p> <p>Tap with a hammer onto the load cells. Do not be afraid to break it. Repeat the test for each load cell.</p>

			<p>Measure resistance with ohm meter between wires and load cell body. Do this with the other load cells disconnected from indicator. No resistance is allowed.</p> <p>The load cells should have +/- 350 ohm between the signal wires: yellow and green, and excitation wires, black and red.</p>
		Check cables	<p>Bad connections will cause changes when moving the scale.</p> <p>Bend and move the cable briskly especially where the cable is moving continuously while lifting. While doing so, look at the display to see if it reacts to the movements.</p>
		The potentiometers with which we calibrate the output of the load cells, are mechanical parts therefore, higher risk components	<p>Move the board and but pressure with fingers on the potentiometers while looking at the display to see if it reacts. Do not touch the contact itself.</p>
	Not linear	Check if it is load cells or indicator	<p>Load cells or indicator are very rarely the cause of this problem. Easiest way to check is by changing the indicator temporarily. If problem is not solved when changing the indicator, the problem is the load cell, cable or mechanics</p>
		Check cable	<p>Very rarely the cause. Maybe in a lift truck.</p>
Instability	With no load it is most of the time humidity, bad connection or component r bad shield.	Check for humidity	<p>Check for water marks on the indicator board or load cell connections (potentiometers).</p>
		Check the indicator.	<p>Sometimes the indicator will show a weight when the load cells are disconnected. If you do this and the indicator becomes more stable, it is most likely elsewhere in the system.</p> <p>Check visually for traces of oxidation. If found, heating the solder contacts can solve the problem.</p>
		Check cables. In warehouse and lift truck the cable is working all the time when following the lifting movement. It may be worn or damaged. Changing temperatures and chemicals have an effect on the lifetime of a cable.	<p>Bad connections will cause changes when moving the scale.</p> <p>Bend and move the cable briskly especially where the cable is moving continuously when lifting. While doing so, look at the display to see if it reacts to the movements.</p>
		The potentiometers with which we calibrate the output of the load cells are mechanical parts and are sensitive to humidity, shocks and vibration.	<p>Move the board and but pressure with fingers on the potentiometers while looking at the display to see if it reacts. Do not touch the contact itself.</p>



		Check the load cells.	If connected independently to the indicator, it can be checked which one is unstable and which one is not.
	With load	Check mechanics.	
Function error	No reaction when pushing keys	Check the touch panel	Test can be done by making short cut on connection of the touch panel to simulate a key being pressed. Check for wear of broken contacts in the flat cable going to the indicator board
		Lock up	Take out the battery pack and replace to see if it starts up afterwards.
	Not summing	Operator error	Load is not stable. Scale needs to be unloaded before accepting new print. System will not print weights that are smaller than the graduation.

Error messages

ERROR MESSAGES INDICATOR 320

Display	Meaning	Out of error mode
Err01	Load cell signal is unstable	Automatic
Err02	Overload on full scale	Automatic after removing weight
Err03	Gross negative. This action is not allowed	Automatic
Err04	Out of zero range	Press any key
Err06	Input signal too high	Automatic after correcting input
Err08	Calibration out of range (negative)	Automatic
Err09	Calibration out of range (signal too low)	Automatic
Err10	Calibration count 2nd (3rd) point lower than count 1st (2nd) point	Automatic
Err14	Setpoint value 2 < setpoint value 1. This is not allowed	Automatic
CAL-J	Legal for trade version: action not allowed	When action is intended, remove jumper JP1 (attention: after this action a complete new calibration and stamping of the system is necessary)
Err98	Calibration point must be higher than previous one Action only allowed in start-up units	Automatic
Err99	Loadcell signal negative	Automatic
----	Loadcell signal negative	Lift up the forks from the ground
Err_L	Pallet truck is out of level (only legal-for-trade version)	Put the pallet truck into horizontal position
	Battery of indicator is empty	Charge the battery pack
OimL	Action not allowed (only legal for trade version)	Automatic
ntEP	Action not allowed (only legal for trade version)	Automatic
SCALL	Audit trail no out of range	Contact RAVAS Service department Contact your dealer
ESoFt	Wrong combination of firmwares	Contact your dealer
EConF	P96 not set	Contact your dealer

ERROR MESSAGES RELATED TO INDICATOR 320-BLE ONLY

Display	Meaning	Out of error mode
ErrF1	Problem with transmitter module 1 (no communication)	Indicator will try to reconnect for 30 sec. Restart indicator. Restart transmitter module and indicator.
ErrF2	Problem with transmitter module 2 (no communication)	Indicator will try to reconnect for 30 sec. Restart indicator. Restart transmitter module and indicator.
Er_F1	too few samples for measurement	Wait for improvement of the Bluetooth connection (by moving the mast to lower position)
Er_F2	too few samples for measurement	Wait for improvement of the Bluetooth connection (by moving the mast to lower position)
tiP	too large load on the tip of forks	Replace load
SidE	too large load on one fork	Replace load
 +F1	battery of transmitter module 1 is empty	Replace the Li-ion pack or reccharge
 +F2	battery of transmitter module 2 is empty	Replace the Li-ion pack or reccharge
LobaF	Fork batteries are empty (appears after three times start-up with empty batteries)	Replace the Li-ion pack or reccharge charge the fork batteries

Parameter Settings

ATTENTION: Before entering the setup mode make sure that the battery supply is sufficient. A low battery may cause the micro-processor to block. If this happens remove the empty battery and replace it with a fully charged battery. You should be able to start the indicator in the normal way.

To enter the setup mode, turn on the indicator and keep the ① key pressed for 20 seconds. You will go through the normal start-up routine (all segments on; software version; calibration number and weight) and end up in the “P_01” with the right digit flashing.

At this stage you may proceed as follows:

- To enter parameter 01 press the ← key quickly.
 - The display will show the setting for this parameter at this moment.
- You may change the setting by using the ^ or the v key.

OR

- You can accept the setting by pressing ←.

OR

- To move to the next parameter you press the ^ key.

OR

- To move to the previous parameter you press the v key.

- To leave the set-up mode you do the following:
 - With P_XX in the display press the ① key quickly.
 - The display will show “P_00”
 - Press the ① key again quickly.
 - If a change was made to the settings the display will show “SET_” briefly and then return to the normal weighing mode. The calibration number will be increased by every time a change was made in the set up and also after a new calibration.
 - If no change was made, the display will return into the normal weighing mode.

In the following pages the different parameters are explained and the standard settings are given. Parameters that are not used yet will not be accessible or displayed with underscores.

Parameter	Function	Settings	Default US
01	Start-up unit (and print units)	1=kg / 2=lb	2
02	Smallest graduation step for multi-range	0.1/0.2/0.5.....10/20/50	0.5
03	Largest graduation step for multi-range	0.1/0.2/0.5 10/20/50	2
04	Number of graduations for every range	0000-9900 divisions	1000
05	Weighing capacity system (full scale)	0000-99999 units	5000
06	Motion tolerance for stable	0-32 off 0.5 grad./sec 1 grad./sec 2 grad./sec 4 grad./sec 8 grad./sec 16 grad./sec 32 grad./sec	1
07	Filter size	0-12 0=off 1=light filtering, 12=heavy filtering	8
08	Auto zero range	0=off 0.5 division 1=division 3 divisions	0.5
09	Zero range positive (+)	0-100% (approved 2%) of span	10
10	Zero range negative (-)	0-100% (approved 2%) of span	10
11	Test Function	BASIC ADC Counts 10x Resolution	bASIC
12	Power On zero	Yes / No	No
13	Approved	None, NTEP, OIML, NTEPC	None
14	Start-up number to add in sampling mode	1-2-5-10-20-50-95	10
15	Units switch mode active	Yes / No	No
16	Setpoint function	0-14 0 (not used), 1 (gross overload), 2 (net overload), 3 (fill manual tare), 4 (fill auto tare), 5 (gross overload not authorize to change gross settin), 6 (net overload not authorize to change net setting), 7(gross overload delayed), 8 (net overload delayed), 9 (gross overload delay not authorize to change gross setting), 10 (net overload delay not authorize to change net setting),11 (gross overload+errors), 12(gross overload+err, no changes allowed), 13(gross overload+err, delayed), 14(gross overload+err, no changes allowed, delayed)	0

Parameter	Function	Settings	Default US
17	Sense active (4 or 6 wire)	4; 6	4
18	Gravity value working area	9.750-9.850	9.797
19	Print format time/date	European format dd/mm/yy hh:mm American format mm/dd/yy hh:mm	<u>USA</u>
20	Baudrate comport 1	600-1200-2400-4800-9600-19200	9600
21	Databits comport 1	8_n_1;8_n_2;7_n_1;7_n_2;7_E_1;7_E_2;7_o_1;7_o_2	8_n_1
22-23	Not used		
24	End character comport 1	CR/LF/CRLF	cr
25	Dataprotocol comport 1	0 = PC (bi-directional) 1 = PC Excel format on print command 2 = remote display 3 = printer with power control 4 = printer without power control 5 = not used 6 = PC excel format on print command with ACK/NAK 7 = special 1 8 = special 2	0
26	Number of linefeeds comport 1	0-9	0
27	Handshake com1	soft (Xon/Xoff);hard (CTS)	soft
28	printout format for com1 and com2	stand;total;conf	stand
29	header lines added	0 - 3	0
30	Baudrate comport 2	600-1200-2400-4800-9600-19200	9600
31	Databits comport 2	8_n_1;8_n_2;7_n_1;7_n_2;7_E_1;7_E_2;7_o_1;7_o_2	8_n_1
32-33	Not used		
34	End character comport 2	CR/LF/CRLF	CR

Parameter	Function	Settings	Default US
35	Dataprotocol comport 2	0 = PC (bi-directional)	3
		1 = PC Excel format on print command 2 = remote display 3 = printer with power control 4 = printer without power control 5 = not used 6 = PC excel format on print command with ACK/NAK 7 = special 1 8 = special 2	
36	Number of linefeeds comport 2	0-9	5
37	Handshake com2	Soft/hard	Soft
38	Print twice	0=print only once 1=Print twice	0
39	Not used		
40	Level switch	NO; LS NC; LS NO; CS FA; CS RA; CS LS	NO
41	Delay trigger time level switch	0-10 sec.	3
42	Not used		
43	Comp. factor cf	0.1 to 10.0 (not used)	1.0
44	Comp. factor rdx	0.1 to 10.0 (not used)	1.0
45	Comp. factor rdy	0.1 to 10.0 (not used)	1.0
46	T comp. factor zero	(not used)	1.0
47	Not used		
48	T comp. factor span	(not used)	0
49	Underload % of FS	0-100 %	2
50	Peak hold time RCS	0-7	4
51	Threshold value RCS	9999 kg/lb	100.0
52	Peakhold function (RCS function)	0= OFF 1= ON (RCS function active)	0
53-58	Not used		
59	Measuring frequency	10 or 80 Hz	10
60	Battery used	12VDC 6VDC	12v
61	Low Bat switch off time	0-99 minutes 0= not switched off	2
62	Auto shut off time if not used	0-99 minutes 0= always on	30
63-64	Not used		
65	Auto shut off time backlight	0; 20; 40; 80; 160; 320 seconds	20
66	Backlight brightness	100; 75; 50;20;0 %	100
67	Not used		
68	Buzzer function	No/yes	No
69	Disable keys 2, 3 and 4 (only if P16= active)	0-3	0

Parameter	Function	Settings	Default US
70	Auto Tare release(at empty scale)	No/yes	No
71-89	Not used		
90	Reset to default parameter settings without altering calibration parameters	If parameter 01 was on 1 it will default to the EU settings, if P01=2 the US settings will be defaulted. New delivered boards will have the EU settings.	
91	Reset to default parameter settings including calibration parameters	If parameter 01 was on 1 it will default to the EU settings, if P01=2 the US settings will be defaulted. New delivered boards will have the EU settings.	
92	Recall factory settings calibration		
93	Read out last 10 error messages		
94	Not used		
95	Factor used only		00000
96	Printout parameter setup	Pr-C1: Pr-C2	Pr-C1
97	Key test function (buzzer and Nr)		
98	Scale ID number	0-999	1
99	Firmware version	(last available version	215A