

FBx Indicator

Instruction Manual

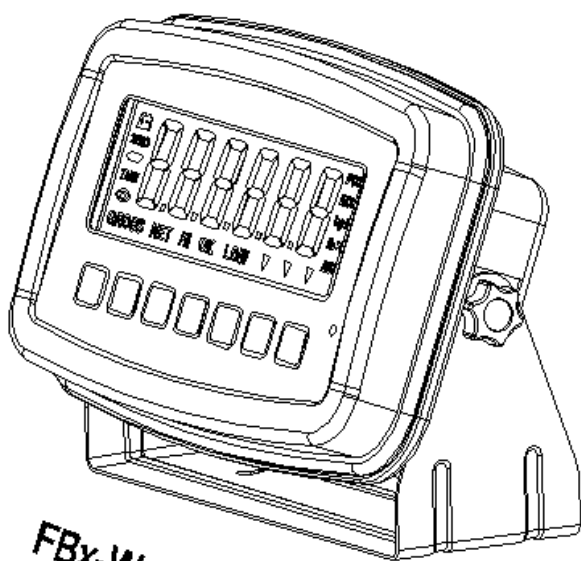

FBx-W Indicator

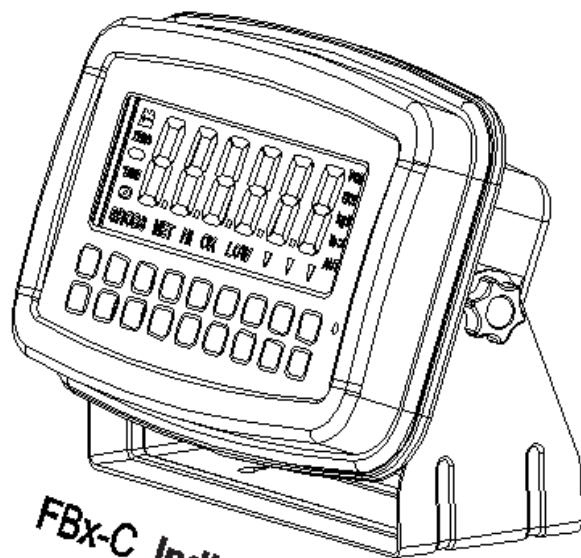

FBx-C Indicator

TABLE OF CONTENTS FOR FBx INDICATOR

1. INTRODUCTION	EN-5
1.1 Description.....	EN-5
1.2 Features	EN-5
1.3 Safety Precautions.....	EN-6
1.3.1 Power Option Safety Precautions.....	EN-7
2. INSTALLATION	EN-7
2.1 Unpacking and Checking.....	EN-7
2.2 Precautions.....	EN-8
2.3 Making Connections to the Indicator.....	EN-9
2.3.1 RS232 Connections.....	EN-11
2.3.2 Load Cell Connections.....	EN-12
2.3.3 Power Adapter.....	EN-15
2.3.4 Battery Power.....	EN-15
3. OPERATION	EN-17
3.1 Overview of Parts and Controls	EN-17
3.1 Overview of Parts and Controls (Continued).....	EN-18
3.1 Overview of Parts and Controls (Continued).....	EN-19
3.2 Control Functions.....	EN-20
3.3 Menu	EN-22
3.3.1 Menu Structure.....	EN-22

FBx Series Indicator

3.3.2 Parameters Menu Structure.....	EN-25
--------------------------------------	-------

TABLE OF CONTENTS FOR FBx INDICATOR

3.3.3 Menu Navigation.....	EN-27
3.3.4 Data Inputting.....	EN-27
3.4 Turning Indicator On/Off.....	EN-28
3.4.1 Turning On.....	EN-28
3.4.2 Turning Off.....	EN-28
3.4.3 Stabilization.....	EN-29
3.5 Setup Settings.....	EN-29
3.5.1 Settings of Checkweighing.....	EN-29
3.5.2 Accumulation and RS-232 communication Settings.....	EN-30
3.5.3 Date and Time Settings.....	EN-32
3.5.4 To set auto off, backlight and display.....	EN-33
3.5.5 The calibration event counter.....	CN-34
3.6 Scale Settings.....	EN-35
3.6.1 Calibration Settings.....	EN-35
3.6.2 Gravity Settings.....	EN-37
3.6.3 Scale Parameter Settings.....	EN-37
3.6.4 Set the units On/Off.....	EN-39
3.7 Application Modes.....	EN-40
3.7.1 Weighing.....	EN-40
Zero Operation.....	EN-40

FBx Series Indicator

Basic Weighing.....	EN-41
---------------------	-------

TABLE OF CONTENTS FOR FBx INDICATOR

Changing Units of Measure.....	EN-41
Manual Tare.....	EN-41
Pre-set Tare.....	EN-42
Displaying Gross, Net.....	EN-43
Printing Data.....	EN-44
3.7.2 Accumulation Operation.....	EN-44
3.7.2.1 Manual Accumulation Operation.....	EN-44
3.7.2.2 Auto-Accumulation Operation.....	EN-46
3.7.2.3 Accumulation Operation Precautions.....	EN-46
3.7.2.4 Displaying Accumulation Result.....	EN-48
3.7.2.5 Clearing Accumulation Result.....	EN-48
3.7.3 Checkweighing.....	EN-49
Beeper and Checkweighing Display Indication.....	EN-49
Summary of Checkweighing Key Functions.....	EN-49
Checkweighing Operation.....	EN-50
3.7.4 Counting.....	EN-53
4. CARE AND MAINTENANCE.....	EN-57
4.1 Calibration.....	EN-57
4.1.1 Any Value Calibration.....	EN-57
4.1.2 Gravity.....	EN-63

FBx Series Indicator

4.2 Troubleshooting.....	EN-65
--------------------------	-------

TABLE OF CONTENTS FOR FBx INDICATOR

4.3 Cleaning.....	EN-66
-------------------	-------

4.4 Service information.....	EN-66
------------------------------	-------

4.5 Battery Replacement.....	EN-66
------------------------------	-------

4.5.1 RTC Battery Replacement.....	EN-67
------------------------------------	-------

4.5.2 Rechargeable Lithium Battery Replacement.....	EN-68
---	-------

5. TECHNICAL DATA.....	EN-69
-------------------------------	--------------

5.1 Drawings and Dimensions.....	EN-69
----------------------------------	-------

5.2 Technical Data.....	EN-70
-------------------------	-------

5.3 Specifications.....	EN-70
-------------------------	-------

6. ACCESSORIES AND OPTIONS.....	EN-72
--	--------------

APPENDIX A LEGAL FOR TRADE.....	EN-72
--	--------------

A.1 Locking Metrological Parameters.....	EN-73
--	-------

A.2 Verification.....	EN-73
-----------------------	-------

A.3 Sealing.....	EN-74
------------------	-------

APPENDIX B MOUNTING BRACKET.....	EN-75
---	--------------

APPENDIX C SERIAL COMMUNICATION.....	EN-76
---	--------------

C.1 Interface Commands.....	EN-76
-----------------------------	-------

C.2 Output Protocol	EN-77
---------------------------	-------

C.3 Output Example	EN-77
--------------------------	-------

APPENDIX D CAPACITY AND GRADUATION TABLE.....	EN-78
--	--------------

1. INTRODUCTION

This manual contains installation, operation and maintenance instructions for the FBx Indicator and FBx Series Scales. Please read this manual completely before installation and operation.

1.1 Description

The FBx Series is a dedicated static checkweighing product line with enhanced software and simplified user functionality. FBS is stainless steel construction. Its easy-to-clean, hygienic design makes it specifically ideal for food processing and other wet-environment applications.

Behind this instrument stands Furi, An Aftermarket Department with trained instrument technicians is dedicated to providing the fastest service possible in the event this instrument requires servicing. Furi also has a Customer Service Department to answer any inquiries regarding applications and accessories.

1.2 Features

Major features include:

- NEMA 4X / IP66 protection, FBS is Stainless steel enclosure.
- Table/Wall mount bracket included (Indicator only configuration).
- High-contrast 1.3"/33 mm high, 6-digit, 7-segment LCD weight display, with HI-OK-LOW checkweigh indication and audible signal.

FBx Series Indicator

- Flexible unit switching: kg, g, lb, oz.
- Fast < 2 seconds display updates speed.
- Geographical adjustment function for certification in applicable areas.
- Bi-directional RS232 interface.
- USB interface
- AC to DC Power Adapter: AC 100-240V 50/60Hz Input, DC 12V 1000mA Output.
- Internal rechargeable Lithium battery, long standby time.

1.3 Safety Precautions



For safe and dependable operation of this equipment, please comply with the following safety precautions:

- Verify that the input voltage range printed on the data label matches the local AC power to be used.
- Make sure that the power cord does not pose a potential obstacle or tripping hazard.
- Use only approved accessories and peripherals.
- Operate the equipment only under ambient conditions specified in these instructions.
- Disconnect the equipment from the power supply when cleaning equipment.
- Do not operate the equipment in hazardous or unstable environments.
- Do not immerse the equipment in water or other liquids.

- Service should only be performed by authorized personnel.

1.3.1 Power Adapter Option Safety Precautions

Please use only approved Power Adapter.



CAUTION: ELECTRICAL SHOCK HAZARD. REMOVE ALL POWER CONNECTIONS TO THE INDICATOR BEFORE SERVICING OR MAKING INTERNAL CONNECTIONS. THE HOUSING SHOULD ONLY BE OPENED BY AUTHORIZED AND QUALIFIED PERSONNEL, SUCH AS AN ELECTRICAL TECHNICIAN.

Before making connections to the Power Adapter, remove power from the system. If the system contains an optional rechargeable battery, be sure

that the  button is used to fully turn off the system after removing the AC power plug.

More detailed installation instructions are included with the Power Adapter when purchased.

2. INSTALLATION

2.1 Unpacking and Checking

Unpack and verify that the following components have been included:

- FBx Indicator
- Instruction Manual
- Mounting Bracket (with stand-alone indicator)
- Weights and Measures Kit

- Warranty Card

Retain all of the original packaging materials in the event the unit has to be transported or stored.

2.2 Precautions

- This equipment should be used in an environment free from vibration, temperature extremes or highly corrosive conditions.
- These factors may affect normal operation of the unit.
- Scale bases used with the FBx Indicator must be located on a stable level surface and kept away from vibrating sources such as large machinery or appliances.
- Adjust the leveling feet so that the bubble is centered in the circle of the level indicator located in the rear of the scale.

Note: 1. Ensure that the scale is level each time its location is changed.

2. Before Weighing

Whenever possible, allow the scale to warm up more than thirty (30) minutes. This gives the scale a chance to adjust to its new environment.

2.3 Making Connections to the Indicator

The FBx Indicator housing contains 4 liquid-tight connectors at the bottom for external cabling.

Figure 2-1 illustrates the locations of the liquid-tight connectors.

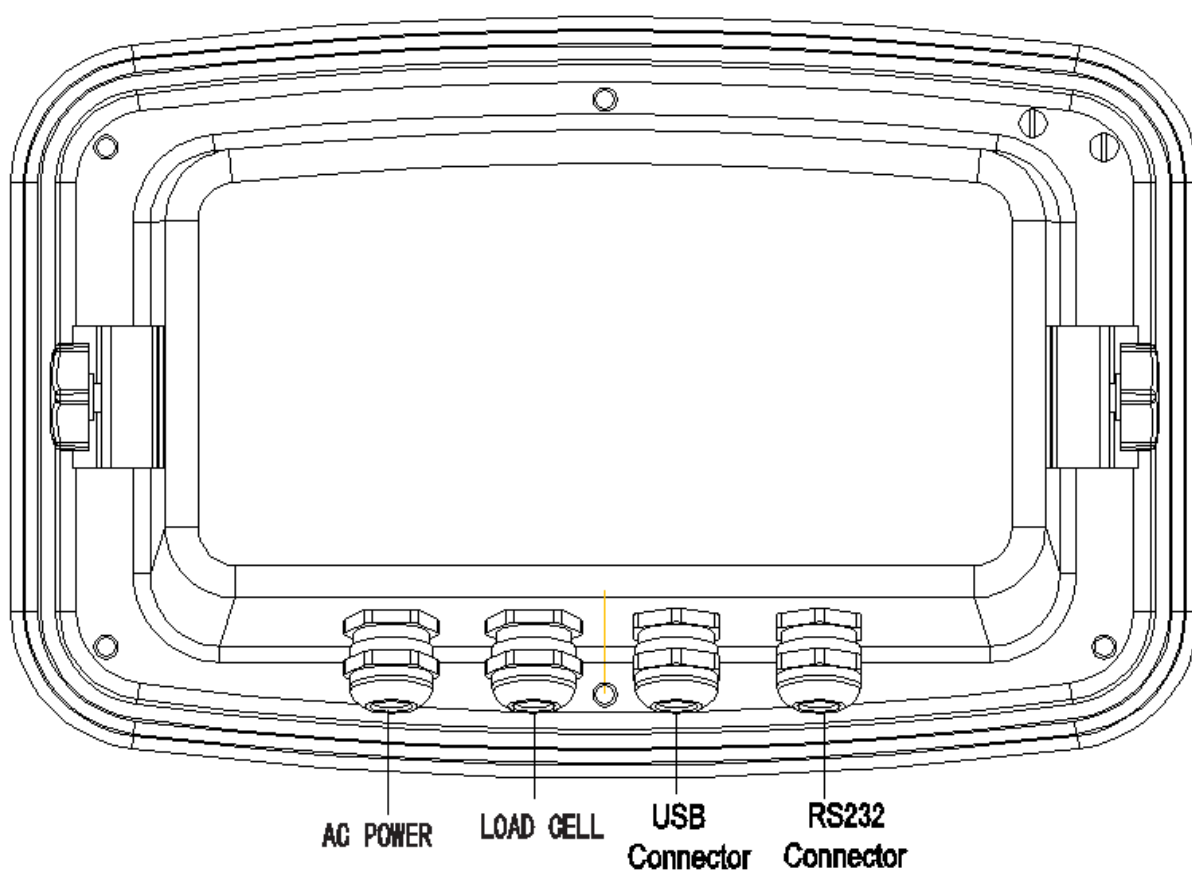

Figure 2-1. Cable Entry Identification

FBx Series Indicator

FBx Printed Circuit Board Connections, As shown in Figure 2-2 :

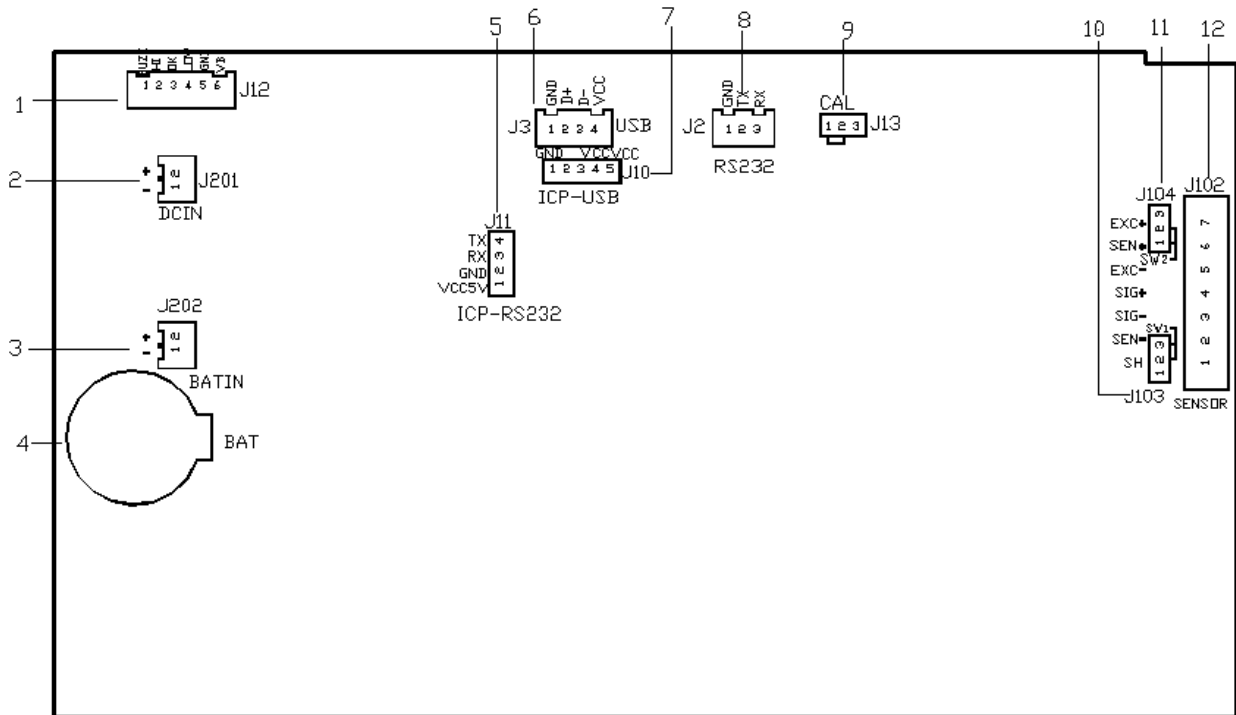
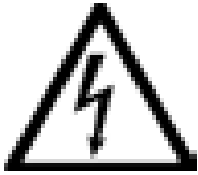

Figure 2-2 Printed Circuit Board Connections

Table 2-1 FBx Printed Circuit Board Connections

Item	Description
1	Checkweighing Interface J12
2	Power Interface J201
3	Battery Interface J202
4	Real-Time Clock (RTC) battery Interface BAT
5	ICP-RS232 Interface J11
6	USB Interface J3
7	ICP-USB Interface J10
8	RS232 Interface J2
9	Sealing Interface J13
10	4/ 6-wire load cell switching Jumper J103、 J104
11	
12	Load cell terminal J102

2.3.1 RS232 Connections



CAUTION: ELECTRICAL SHOCK HAZARD. REMOVE ALL POWER CONNECTIONS TO THE INDICATOR BEFORE SERVICING OR MAKING INTERNAL CONNECTIONS.

THE HOUSING SHOULD ONLY BE OPENED BY AUTHORIZED AND QUALIFIED PERSONNEL, SUCH AS AN ELECTRICAL TECHNICIAN.

Connecting RS232 Interface Cable

The FBx Indicator is equipped with a bidirectional RS232 interface for communication with external printers or computers. Only two signal wires and ground are required.

To connect the RS232 cable, proceed as follows:

- Unfasten the side screws of the indicator housing and remove the front cover by pulling forward.
- Pass the communication cable through one of the I/O liquid-tight connectors at the bottom of the indicator housing.
- Match the wire signals to connector J2 on the main PC board and connect the cable accordingly. See Figure 2-3
- Connect the opposite end of the communication cable to the communication device.

FBx Series Indicator

- Reinstall the front cover and make sure the liquid-tight connector is tight.
- Refer to section 3.6.2 to set up the proper communication parameters.

Figure 2-3 illustrates how to connect RS232 cable

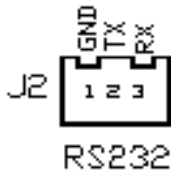

Pin	Signal
1	GND
2	TX
3	RX

Figure 2-3 RS232 Interface on PCB

Table 2-2 RS232 Interface

2.3.2 Load Cell Connections

Load Cell Interface

The locations of the printed circuit board connections are shown as Figure 2-4.

The FBx Indicator is equipped with 5pin aviation plug. Match the wire signals to connector J102 on the main PC board and connect the cable accordingly. (The cable has been connected before delivery)

Figure 2-4 Load cell connections

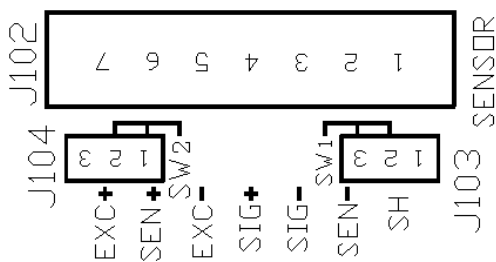

Table 2-3 Load cell connections

Item	Description
EXC+	Positive Excitation
SEN+	Positive Sense
EXC-	Negative Excitation
SIG+	Positive Signal
SIG-	Negative Signal
SEN-	Negative Sense
SH	Shield

Figure 2-5 illustrates connecting Load cell cable to 5pin Aviation female plug

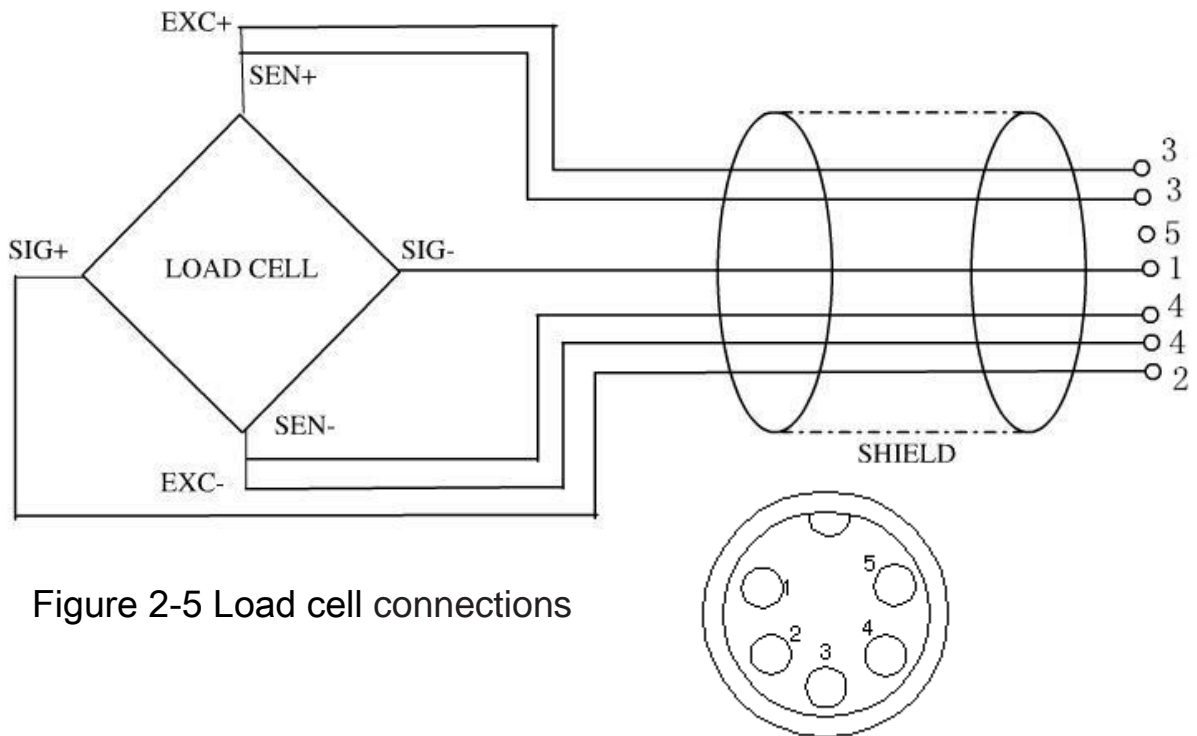

Figure 2-5 Load cell connections

5pin Aviation female plug

Jumper Positions

When connecting a 4-wire load cell with no SEN wires, Jumpers sw1 and sw2 must be left in place shorting the two pins. See Figure 2-6

When connecting a 6-wire load cell that includes SEN wires, Jumpers sw1 and sw2 must be removed.

When connecting a load cell with an extra ground shield wire: The shield wire may be connected to the first Pin of J102 .

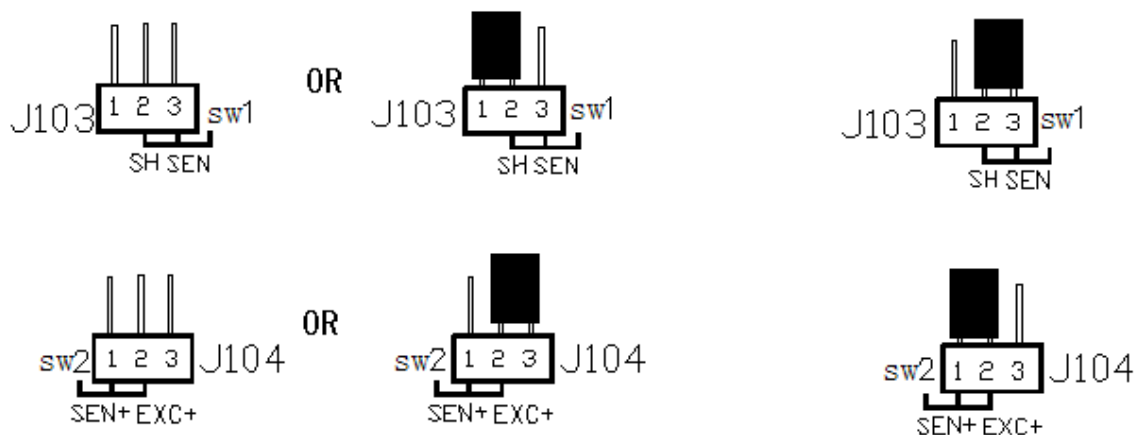

Open Jumpers

Shorted Jumpers

Figure 2-6. Open and Shorted Jumpers

FBx Series Indicator

After wiring is completed and jumpers are in place, replace the switch cover and securing screws on the main PC board.



Replace the indicator housing screws. Make sure the liquid-tight connector is properly tightened.

2.3.3 Power Adapter

Plug the AC power cord into a properly grounded power outlet. The FBx Indicator utilizes a universal switching power supply, AC 100-240V 50/60Hz Input, DC 12V 1000mA Output.

2.3.4 Battery Power

The scale can be operated on the internal rechargeable battery when AC power is not available. The scale will automatically switch to battery operation if there is a power failure or the power cord is removed. A fully charged battery can operate the scale for over 16 hours independent of the AC power line.

When the battery requires charging, Low Battery Indicator  is displayed during operation. When the battery is fully discharged LCD will display , The scale will automatically turn off . At this time, please recharge in time, otherwise the scale will not be able to continue to

FBx Series Indicator

use.

With AC power applied to the scale, a Yellow led may light up, which means charging is in progress. Turning to a green led indicates that the battery is fully charged.

It's not necessary to turn on the power when the scale is during charging process. It takes 3 hours at least to charge the battery fully.



Before using the scale on battery power for the first time, the internal rechargeable battery requires charging for up to 10 hours. The scale can be operated on AC power adapter during the charging process. The battery is protected against over charging and the scale can remain connected to the AC power line.



CAUTION

BATTERY IS TO BE REPLACED ONLY BY AUTHORIZED
SERVICE PERSONNEL.

RISK OF EXPLOSION CAN OCCUR IF REPLACED WITH THE
WRONG TYPE OR CONNECTED IMPROPERLY.

3 OPERATION

3.1 Overview of Parts and Controls

FBx Series Indicator

Table 3-1. **FBx-C Indicator
Parts and Controls**

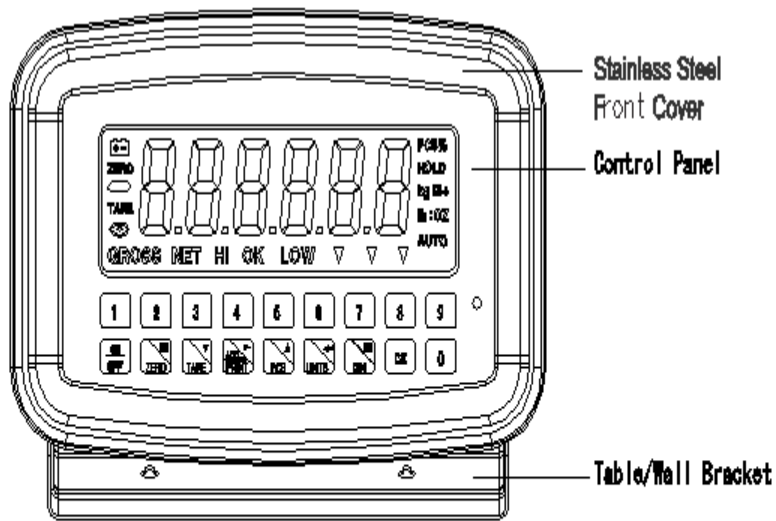

Item	Description
1	Stainless Steel Front Cover
2	Control Panel
3	Table/Wall Bracket
4	Housing Screws
5	Seal Screws
6	Stainless Steel Back Cover
7	Mounting Holes for Table/Wall Bracket
8	Rubber Grommet Washer
9	Bracket Knob
10	Liquid-tight Connector

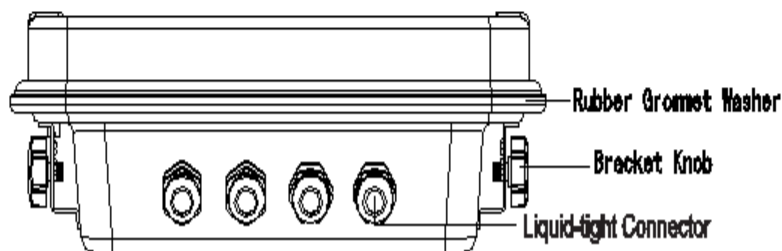
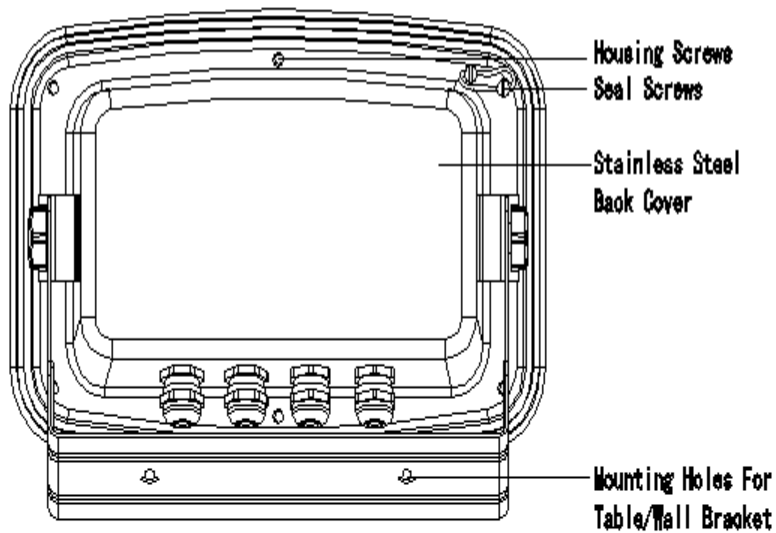

FBx Series Indicator

Figure 3-1. FBx-C Indicator

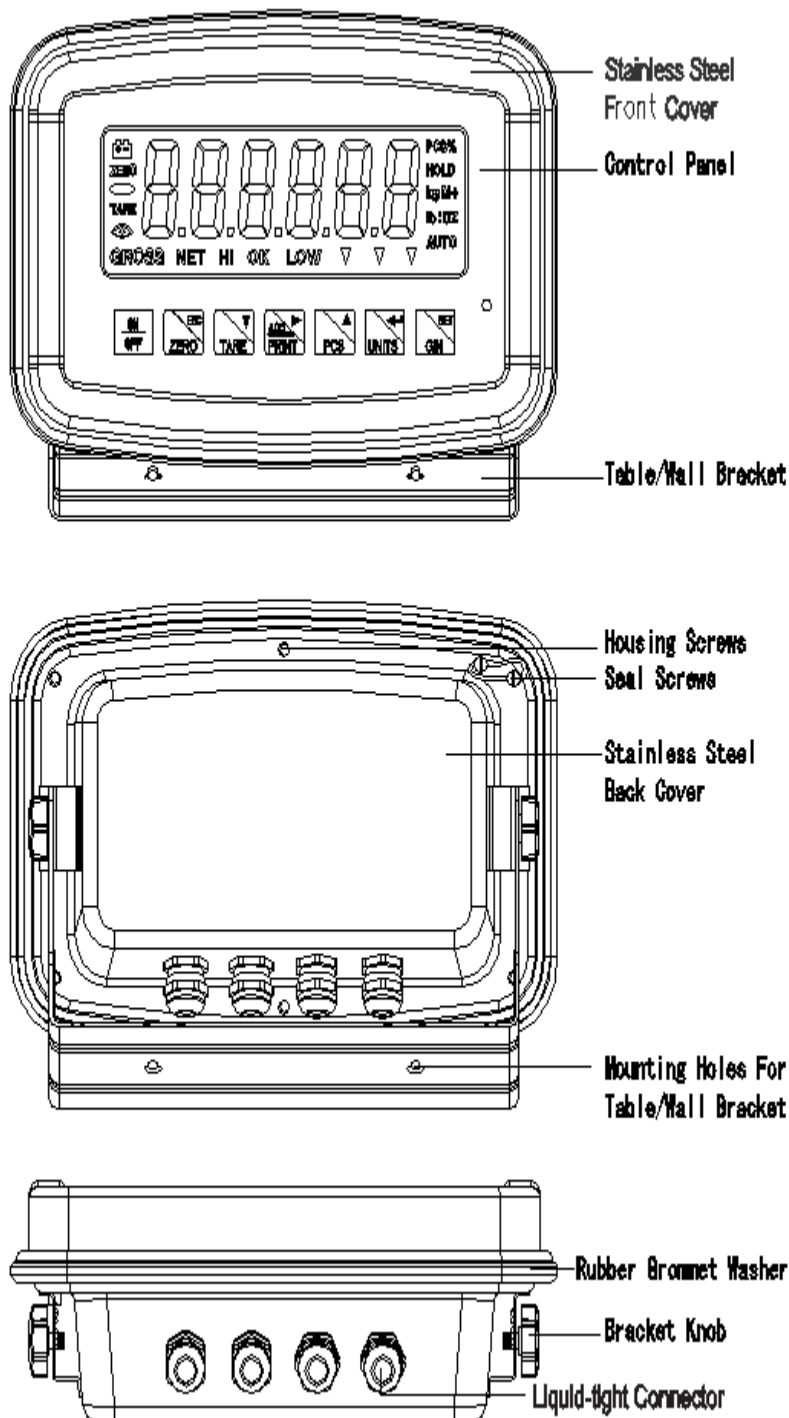

3.1 Overview of Parts and Controls (Continued)

Table 3-2 FBx-W Indicator Parts and Controls

Item	Description
1	Stainless Steel Front Cover
2	Control Panel
3	Table/Wall Bracket
4	Housing Screws
5	Seal Screws
6	Stainless Steel Back Cover
7	Mounting Holes for Table/Wall Bracket
8	Rubber Grommet Washer
9	Bracket Knob
10	Liquid-tight Connector

Figure 3-2 FBx-W Indicator

3.1 Overview of Parts and Controls (Continued)

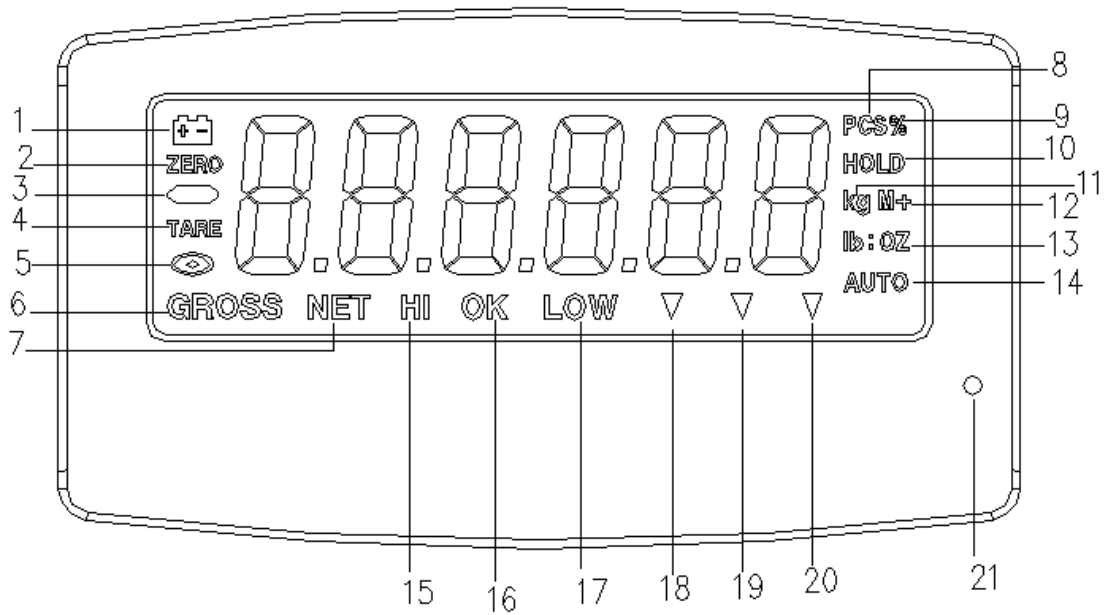

Figure 3-3. Display and Indicator

Table 3-3 Display and Indicator

Item	Description
1	Low Battery Indicator

FBx Series Indicator

2	Zero Indicator
3	Negative Indicator
4	Tare Indicator
5	Stable Indicator
6	Gross Indicator
7	Net Indicator
8	Counting Indicator
9	Percentage Indicator
10	Hold Indicator
11	kg, g Unit Indicators
12	Accumulation Indicator
13	lb, oz Unit Indicators
14	Auto Indicator
15	over checkweighing Indicator
16	Accept checkweighing Indicator
17	under checkweighing Indicator
18	Calibration Indicator
19	Current Weight Indicator
20	Total Weight Indicator
21	Battery Charging Indicator

3.2 Control Functions

Key Board

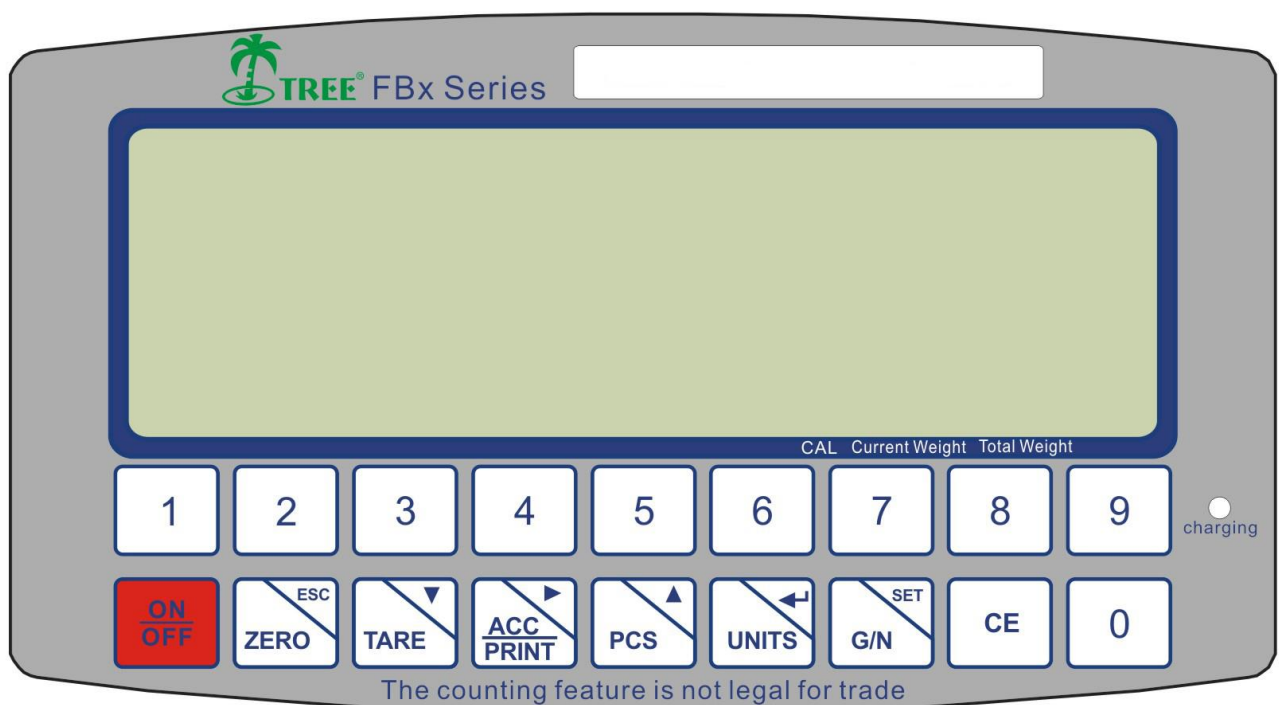

FBx Series Indicator

Figure 3-4 FBx-C Indicator Key Board

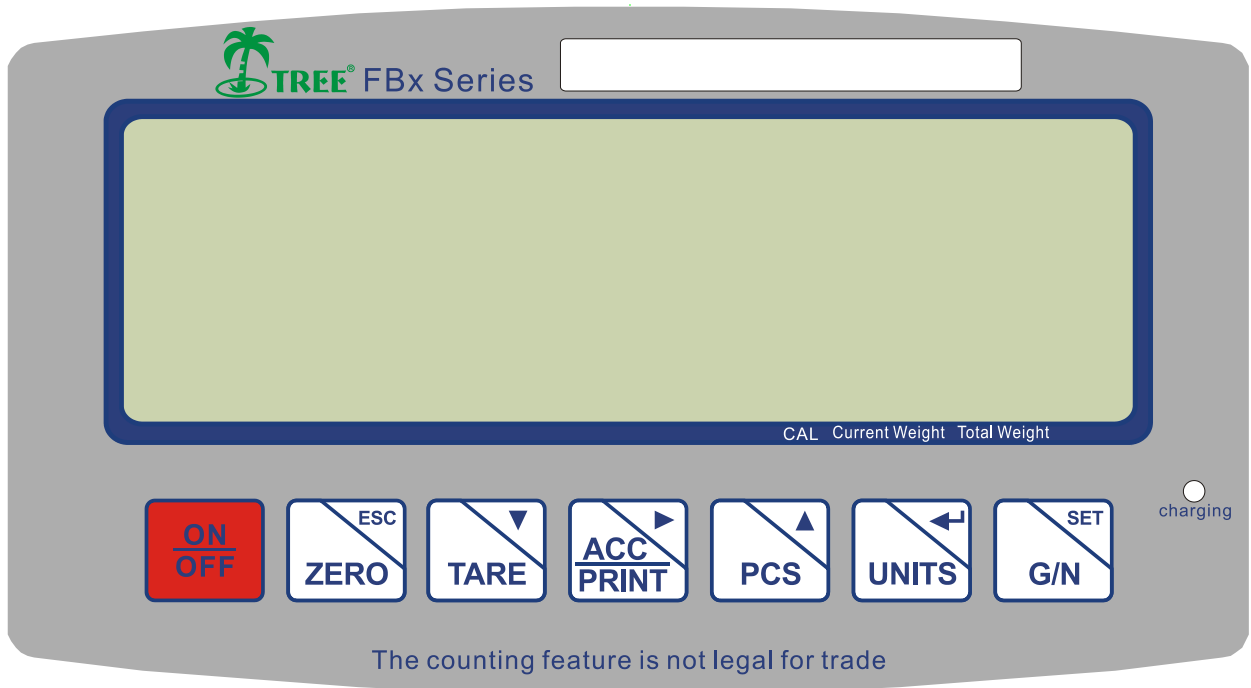









Figure 3-5 FBx-W Indicator Key Board

Table 3-4. Keys Description

Keys	Main Function	Secondary Function
	Turns the indicator ON/OFF	
	Performs Zero operation	Escape from the menu to normal operation
	Performs Tare operation, Subtracts weights.	The digit decrease one
	<ul style="list-style-type: none"> ▪ Accumulator key ▪ To send the data to printer 	To move the active digit to right



FBx Series Indicator





	or PC	
	Counting	<ul style="list-style-type: none"> ▪To change the menu ▪The digit adds one
	To change the units	To confirm the selected menu
	Shift between Gross & Net Weight.	To enter into the menu
	Clear the digits	

3.3 Menu

3.3.1 Menu Structure

- **To enter the menu mode:** Turn on the scale, and then the scale will enter the self checking mode.

- Press  key when display shows , and then the display will show .

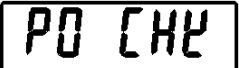
- Press  key,  key,  key and  key to enter the setting mode, the display will show .

FBx Series Indicator

- Press  key to change the menu. The options are P0 [CHK],

P1 [On], P2 [DAY], P3 [oEH], P4 [n_].

- Press  key to allow entry into the displayed menu.

- Press  key to exit the current setting menu.

Menu	Sub Menu	Description	
P0 chk	This option is used to set checkweighing		
	Set H	Set high limits for checkweighing	
	Set L	Set low limits for checkweighing	
	beep	NONE	No beep for checkweighing
		Ok	Beep, when checkweighing between the limits
		ng	Beep, when checkweighing out of the limits

Menu	Sub Menu	Description	
P1 com	This option is used to set accumulation and RS-232 communication		
	Mode	Cont	Send data continuously
		St 1	Send data one time, when stable.
		St c	Send data continuously, when stable
		P r1	Send data one time, when press print Key (in printer mode)

FBx Series Indicator

		P r2	Send data to print and accumulation,when press print Key (in printer mode)
		Auto	Auto accumulate and auto print mode When weight stable and return to zero
		Ask	Ask mode
			Command R: Read data
	Command T: Tare		
	Baud	Command Z: Zero	
		To set the baud rate Options: 1200 / 2400 / 4800 / 9600	
	Pari	To set the parity : Options: 7e / 7o / 8n	

Menu	Sub Menu	Description	
P2 day	date	To set the date for Print function. xx.xx.xx	
	time	To set the time for Print function. xx.xx.xx	
P3 oth	AoFF	oFF	To set auto off function turn off, for scale always on.
		oF 3	Set to turn off three minutes later.
		oF 5	Set to turn off five minutes later.
		oF15	Set to turn off fifteen minutes later.

FBx Series Indicator

	bL	Au	To set auto option. When start to use back light will be on and when stop the operation back light also will off.
		on	To set always on. After turn on the power, back light also will be on.
		oFF	To set back light turn off. No back light in the operations
	Disp	To set date and time display or no. Options: on / oFF	
	Pr t	To set date and time Print or no. Options: on / oFF	
	E d	To set the relationship between E and d. Options:E= 10d / E= 1d	
P4 Cn_	Cn-000	Display the times of calibration.	

3.3.2 Parameter Menu Structure

To enter the parameter menu mode:

- Open the indicator housing, Short the CAL jumper of J13 on the main PC

board. See  J13

- Press  key to turn on the indicator. The system will enter the self checking mode.

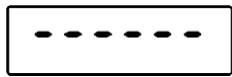
- Press  key when the display shows , the display will

show .

FBx Series Indicator

- Press  key to select the setting menu in menu mode. The options

are CAL,, GrA,, rAnGE, Un it.

- Press  key to allow entry into the displayed menu.

- Press  key to exit the current setting menu.

Menu	Sub Menu	Description
Cali	F=0050lb	Set Capacity
	C=0050lb	Set Calibration Weight
	d=0.01lb	To set division Options: 0.002 / 0.005 / 0.01 / 0.02 / 0.05 / 0.1 / 0.2 / 0.5 / 1 / 2 / 5 / 10
Gra	Grasw	To set gravity Options: on / oFF
	Gra C	To set the manufacturer local gravity C9.7893
	Gra U	To set the user local gravity U9.7893

FBx Series Indicator

Range	AtZ	To set the range of zero tracking Options: 0.5d / 0d
	PZr	To set the range of power-on zero Options: 0% / 2% / 3% / 4% / 5% / 10% / 20% / 100%
	KZr	To set the range of Manual Zero Options: 2% / 4% / 10% / 100%
	Ktr	To set the range of Manual Tare Options: 50% / 100%
	Ovr	To set the range of Overloading Options: 0% / 5%
Unit	U1En	To set the first unit enable Options: on
	U2En	To set the second unit enable Options: on / oFF
	U3En	To set the third unit enable Options: on / oFF
	U4En	To set the fourth unit enable Options: on / oFF

3.3.3 Menu Navigation

Summary of button navigation functions in menu mode:



Allows entry into the current menu.



Accepts the displayed setting and advances to the next menu item;
Flashing digit add by 1 in menu mode.













Move flashing digit to right by 1 space in menu mode.



Exit from the current menu directly to return the former menu.

3.3.4 Data inputting





FBx-C Indicator data input method:

FBx-C Indicator use number keys     
     input the desired value.

During inputting the desired values, you can press  key to clear all the values at any time .

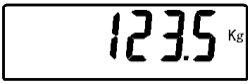
Then enter the new values via the numeric keys.

The numerical input sequence: highest first input, which in turn down, until the last.

For example to enter 123.5 kg  first press  key input 1, then press  ,  ,  key, input 2, 3, 5 sequence.

FBx-W Indicator data input method:

FBx-W Indicator press  key to increase , press once then the value will increase one in sequence, value shows 0, 1, 2, 3, 4, 5, 6 , 7, 8, 9, returns to 0 after increasing to 9.

Press  key to decrease, press once then value will decrease one in sequence.

FBx Series Indicator



After setting up the bit value, press  key to shift the modified digit to the right one, continue to input other values, until all values are finished.



3.4 Turning Indicator On/Off

3.4.1 Turning On

With the scale off, press the  key, the Indicator performs a self

checking after display  , and then goes into the active weighing mode.

3.4.2 Turning Off

To turn the Indicator off, press and hold the  key until  is displayed.

3.4.3 Stabilization

Before initially using the indicator, allow time for it to adjust to its new environment. The recommended warm-up period is at least thirty (30) minutes after the scale has stabilized to room temperature.

3.5 Setup Settings

This section describes the settings available in each menu.

3.5.1 Settings of Checkweighing

This menu item is used to the parameters of Checkweighing mode

FBx Series Indicator

PO [HP

Selections are : Set H /Set L / bEEP

Set H: Set high limits for check weighing

SET H

Set L: Set low limits for check weighing

SET L

bEEP: This menu item is used to define when beeper sounds an (audible

alert) during checkweighing

bEEP

Selections are : none / ok / ng

none: Beeper does not sound.

none

ok: Beeper sounds when the weighed value is within the Accept

range

ok

ng: Beeper sounds when the weighed value is outside of the Accept

range

ng

3.5.2 Accumulation and RS-232 communication Settings

This menu item is used to set accumulation and RS-232 communication

PI [on

Selections are : ModE / Baud / PAri

ModE: RS232 communication settings

modE

FBx Series Indicator

Selections are : Cont /St 1 /St c /P r1 /P r2 /Auto /Ask

Cont: Send data continuously

Cont

St 1: Send data one time, when stable.

St 1

St c: Send data continuously, when stable

St C

P r1: Send data one time, when press print Key (in printer mode)

P r1

P r2: Send data to print and accumulation, when press print Key (in printer mode)

P r2

Auto: Auto accumulate and auto print mode , When weight stable and

return to zero

Auto

Ask: Ask mode

ASK

Command R: Read current weight

Command T: Same as pressing  key.

Command Z: Same as pressing  key

Baud: To set the Baud rate

bAud

Selections are : 1200 / 2400 / 4800 / 9600.

1200 = 1200 bps

FBx Series Indicator

2400 = 2400 bps

4800 = 4800 bps

9600 = 9600 bps

PAri: This menu item is used to define parity

PARI

Selections are : 7e / 7o / 8n

7E = 7 data bits, even parity.

7E

7o = 7 data bits, odd parity.

7o

8N = 8 data bits, no parity.

8n

3.5.3 Date and Time Settings

P2 DAY

Date: Set Date

DATE

Time: Set Time

TIME

Date Setup

Set date Format: YY.MM.DD

This menu item is used to enter the current date via the numeric keypad, (example 16.07.18 for July 18, 2016).

The display flashes the current date. Please refer to section 3.3.4 about

how to input data.

Note: The date is retained in memory even when power is off.

Time Setup

This menu item is used to define the time parameters. Format: 24 hours
HH.MM.SS

This menu item is used to enter the current time via the numeric keypad
(example 01.05.20 for 1:05:20).

The display flashes the current time. Please refer to section 3.3.4 about
how to input data.

Note: The time is retained in memory even when power is off.

3.5.4 To set auto off, backlight and display

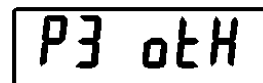

AoFF: To set auto off function



Selections are: oFF / oF 3 / oF 5 / oF 15

oFF: To set auto off function turn off, for scale always on



oF 3: Set to turn off three minutes later

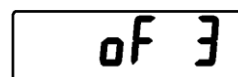

oF 5: Set to turn off five minutes later

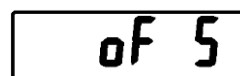

oF15: Set to turn off fifteen minutes later

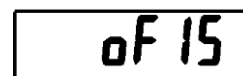

FBx Series Indicator

bL: To set backlight

bL

Selections are: Au / on / oFF

Au: To set auto option. When start to use backlight will be on and when

stop the operation backlight also will off.

Au

on: To set always on. After turn on the power, backlight also will be on.

on

oFF: To set back light turn off. No backlight in the operations

oFF

Disp: To set date and time display or no

d,SP

Selections are: on / oFF

on

oFF

Pr t: To set date and time Print or no

Pr t

Selections are : on / oFF

on

oFF

E d: To set the relationship between E and d

E d

Options: E= 10d / E= 1d

E= 10d

E= 1d

Note: 1.Change will not require a re-calibration.

2.After selecting the desired item "E= 10d" or "E= 1d",

FBx Series Indicator

press  key to confirm the selection.

3. Turn off and restart the scale then the setting will take effect.

3.5.5 The calibration event counter

Cn-000: The calibration event counter will index by 1 when exit the menu if

a calibration is made .



The calibration event counter values range from Cn-000 to Cn-999. When the value reaches Cn-999, the count starts over at Cn-000.

3.6 Scale Settings

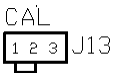

- Open the indicator housing. Shorting the CAL jumper of J13 on the main

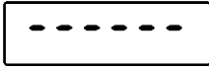
PC board. See .

- Press  key to turn on the indicator, The system will enter the self checking mode.

- Press  key when the display shows , the display will show . The CAL arrow is lighted until the CAL jumper of J13 is removed.

FBx Series Indicator

- Press  key to select the setting menu in menu mode.
- Press  key to allow entry into the displayed menu.
- Press  key to exit the current setting menu.

3.6.1 Calibration Settings



When the display shows , press  key the display will show .

F=0050lb: Set Capacity and Main Unit .

This menu item is used to set the full capacity and main unit of the scale.

The display shows the last Capacity value and main unit entered. Example

50lb,  is displayed.

At this time, press  key to change the main unit for kg, and then the

display will show .

If a different full capacity value is desired, enter the new value via the numeric keypad. Please refer to section 3.3.4 about how to input data.

Values entered refer to Appendix D for typical values.

Note: Changes will require a re-calibration for correct operation.

C=0050lb: Set the calibration weight and unit 

This menu item is used to set the calibration weight and calibration unit.

The display shows the last setting value entered. Example 50lb,

 is displayed.

At this time, press  key to change the calibration unit for kg, and then

the display will show .

If a different calibration weight is desired, enter the new value via the numeric keypad. Please refer to section 3.3.4 about how to input data.

Values entered refer to Appendix D for typical values.

Note: Changes will require a re-calibration for correct operation.

d=0.01lb: To set division .

Selections are: 0.01 / 0.02 / 0.05 / 0.1/ 0.2/ 0.5/ 1/ 2/ 5/ 10/ 0.002/ 0.005.

The unit shown is the main unit that is set in front.

After setting, the scale will enter the calibration.

The Calibration Operation refer to section 4.1.

3.6.2 Gravity Settings

Gra: Gravity 

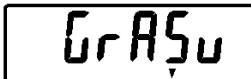
Grasw: To set gravity on / oFF 

FBx Series Indicator

Selections are : on: OFF:

Gra C: To set the manufacturer local gravity , C9.7893

The gravity is setted to match the geographical locations.

Gra U: To set the user local gravity, U9.7893

The gravity is setted to match the geographical locations.

3.6.3 Scale Parameter Settings

AtZ: This menu item is used to define the Auto-Zero Tracking threshold

AtZ minimizes the effects of temperature changes and small disturbances on the zero reading.

The scale maintains the zero display until the threshold is exceeded.

Selections are: 0.5d / 0d

0.5d: ; 0d:

PZr: This menu item is used to define the percentage of full capacity for

Power On Zero

Selections are: 0% / 2% / 3% / 4% / 5% / 10% / 20% / 100%

<input type="text" value="0%"/>	<input type="text" value="2%"/>	<input type="text" value="3%"/>	<input type="text" value="4%"/>
<input type="text" value="5%"/>	<input type="text" value="10%"/>	<input type="text" value="20%"/>	<input type="text" value="100%"/>

FBx Series Indicator

KZr: This menu item is used to define the percentage of full capacity that

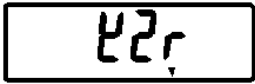
may be cleared by pressing the  key .

Selections are: 2% / 4% / 10% / 100%

Ktr: This menu item is used to define the percentage of full capacity that

may be cleared by pressing the  key .

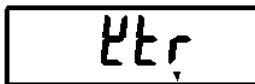
Selections are: 50% / 100%

Ovr: This menu item is used to define the Over load threshold



Selections are: 0% / 5%

3.6.4 Set the units ON/OFF



Selections are: U1En / U2En / U3En / U4En

U1En: To set the first units enable .

Selection is: on



The main unit must be opened and cannot be closed.

U2En: To set the second units enable .

FBx Series Indicator

Selections are: on / oFF

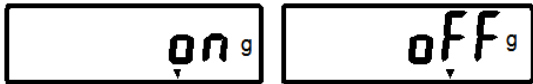

U3En: To set the third units enable .

Selections are: on / oFF



U4En: To set the fourth units enable .

Selections are: on / oFF

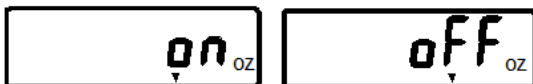

3.7 Application Modes

Before using the Indicator, make sure it has been properly set up and calibrated (refer to section 3.3.2 Menu Navigation and Section 3.6 Setup Menu).

If the unit is received as a scale, it has been factory calibrated and can be operated at this point using the factory default settings. To ensure optimal accuracy, Furi recommends that the Scale be re-calibrated before use (refer to section 4.1 for Calibration and Appendix A Legal for Trade Sealing if required).

3.7.1 Weighing

Zero Operation

Press  key to zero the weight display. The scale must be stable to accept zero operation.

When weight > 4% of full capacity (The percentage of full capacity for

Power On Zero can be set),  key doesn't work.

Usually only zero when there is no item on platform. After zero the display

will show 0 and zero indicator  .

The scale can auto-zero. It can auto-zero when zero drift slightly or light items put on platform.

Press  key to zero the weight display. The scale must be stable to accept zero operation.

Basic Weighing

The platform must be empty before weighing, then place the item to be weighed on the Scale platform. The illustration indicates a sample of 200.0

kg, Gross weight  .

Note: Weight on platform can't exceed the capacity, otherwise the scale

FBx Series Indicator

will display overload . Please immediately remove extra items to avoid damaging the scale.

Changing Units of Measure

Press  key until the desired measuring unit appears. Only measuring units enabled in the Readout-Unit Menu will be displayed (refer to section 3.6.4).

Manual Tare

If necessary press the  key in advance to zero.

When weighing an item that must be held in a container, Place the empty container to be tared on the scale platform (example 20.0 kg)

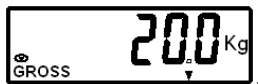

Press the  key. The container weight is tared. The display will show 0

kg, Net weight .



Place the item to be weighed on the Scale platform after taring, The display will show the Net weight. The illustration indicates a sample of

100.0 kg, Net weight .

This scale can be tared repeatedly, and the accumulative result is the ultima tared weight.

FBx Series Indicator

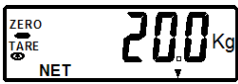
To clear the Tare value, empty the scale platform, the display will show the

tare weight as a negative value . Press the  key, display

will show 0 kg, Gross weight .

Pre-set Tare

A Pre-set Tare (PT) is a known tare value entered through the numeric keypad. The PT value

will supersede any other Tare or PT value in memory.

In weighting mode, Press  key or any number key to initiate a Pre-set Tare, display will show flash data. At this time enter a numeric value using the keypad (Data input method refer to section 3.3.4) (example 1.0 kg

, then press the  key. The PT value will be stored,

and the scale will display net weight .

At this time, press  key again to clear the Pre-set Tare, The weight mode is activated.



Note: 1. If  key is not pressed 5 seconds from the last numeric entry, the display returns to the previous mode without a tare being stored.

FBx Series Indicator

2. To clear a Pre-set Tare value, empty the platform then press  key. The display will return to 0 kg, Gross weight.

Displaying Gross, Net

When a tare has been entered, pressing  key successively displays the Gross, and the Net weights.



Place an empty container on the scale (example 20.0 kg,  is displayed) and press  key. The display will show the net weight 0

and NET indicator .

Put an item after taring, the display will show the net weight. Example

100.0 kg,  is displayed.

Press  key, the display will show gross weight and GROSS indicator

. Press  key again, the display will return to show the

net weight and NET indicator .

(The NET indicator light In the net mode, and the GROSS indicator light In the gross mode).

Printing Data

Printing the displayed data to a printer or sending the data to a computer

FBx Series Indicator

requires that the communication parameters in the Print and Communication Menu are set (refer to section 3.5.2).

Press  key to send the displayed data to the RS232 port (the Auto-Print Mode in Section 3.5.2 function must be Off).



3.7.2 Accumulation Operation

3.7.2.1 Manual Accumulation Operation

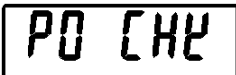

Step 1: Mode is set as “P r2” (Press print Key to send data and accumulate).The method of setting is as follows:

- Enter the menu mode, (refer to section 3.3.1) , the display will show



- Press  key, and the display will show  . Press 

key to enter setting menu and it will display .

- After entering setting menu, then press  key several times continuously, until the scale is under P r2 mode (sending data and accumulation mode).  is displayed at this time.

- Press  key to confirm setting and exit, the setting result will be saved automatically.

Step 2: Press  key to turn off. Press  key again after 3 seconds.

FBx Series Indicator

The scale is turned on then enter the weighing mode



is

Place 20.0kg weight on platform, the display will show



after stable. Press accumulation key



weight. The display will show



first, total weight

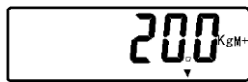

3 seconds later. Accumulation indicator M+ is lighted.

After 5 seconds, the scale will return to weighing mode automatically and

show

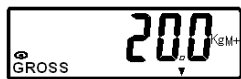

Step 3: Remove the items, and the scale returns to zero .Put the second

item. After stable indicator



is displayed, press the



key. The

display will show



then a new total weight. After 5 seconds,

it will return to weighing mode.

Repeat this step for each additional item.

3.7.2.2 Auto-Accumulation Operation

Mode is set as AUTO (Auto accumulation and auto printing mode).



is displayed.

For method of setting, please refer to section 3.7.2.1 and 3.5.2 .

When the weight on the platform >9d, the total accumulated weight value and times will be accumulated automatically and printed after stable.

To avoid the same items being accumulated repeatedly, please empty the platform (weight displayed<1d) each accumulation so as to start another accumulation.



3.7.2.3 Accumulation Operation Precautions:

1. Keep platform empty (zero indicator ZERO is lighted), stable (Stability indicator  is lighted).

Only when the weight on the platform >9d (division), accumulation function is available. When less than 9d, the display will show .

2. To avoid the same items being accumulated repeatedly, please empty the platform (weight displayed<1d) each accumulation so as to start another accumulation.



Namely when an item is accumulated, remove it firstly, Wait for the scale back to zero, then put on another item.

Weighing value must be stable (Stability indicator  is lighted) after putting on the new items, then press accumulation key , otherwise

FBx Series Indicator

the display will show  .

3. The scale can accumulate up to 99 times, when exceed 99 times then

press accumulation key  , the display will show  .

4. The accumulation weight can't exceed the capacity. Otherwise the scale

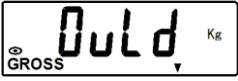
will display overload  . Please immediately remove extra items to avoid damaging the scale.

5. The accumulation weight is up to 999999. If the accumulated value

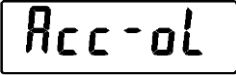
exceeds the display digits,  will be displayed. After this,

Press  key to change units and continue accumulating, Until the

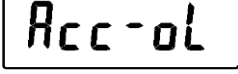
accumulated value exceeds the display digits again,  will be displayed.

6. The total accumulated weight will not be cleared even if weighing units are changed.

3.7.2.4 Displaying Accumulation Results

To view the Accumulation data, long press the  key.

For example, accumulation is done for two times, the total accumulated

weight is 200.0kg. Long press  key, the display will show

FBx Series Indicator

, then the total number of weighed samples

If accumulation doesn't work, press key until the display shows

3.7.2.5 Clearing Accumulation Results

To clear the Accumulation results, press key and key at the same time.

is displayed and the scale returns to active weighing mode,

then the display will show

3.7.3 Checkweighing

The FBx Series features multiple user-configurable checkweighing functions that permit weighing items against preset minimum-maximum and target parameters.

Note: 1. Checkweighing and target entry operations are enabled only when Checkweigh is turned on in the Mode Menu (refer to section 3.5.1, Mode Menu). When enabled from the menu, Checkweigh mode is automatically active upon exiting from the Mode Menu.

FBx Series Indicator

2. The weight of the item being checked is net of any Tare or Pre-set Tare value.

Beeper and Checkweigh Display Indication

The FBx Indicator features an audible Beeper and Checkweigh Display

visual alert .



These checkweigh indication features are easily configurable and can be turned on or off to suit most user preferences.

Summary of Checkweighing Key Functions

Target : Start configure the Checkweigh Menu (refer to section 3.5.1, Mode Menu).

1. Initiates the Target setting.
2. Accepts the displayed values and advances to the next sequence.
3. For data input, please refer to section 3.3.4

Checkweighing Operation

Step 1: In weighing mode, press  and  key together to enter into checkweighing setting menu. The display will show , and the checkweighing mode is turned on.

Step 2: Set the Maximum range value: when the scale



display , Press  key the display flashes the last accept



FBx Series Indicator

value entered. If a different accept value is desired, enter the new value via the numeric keypad. (Data input method refer to section 3.3.4)

Example 100.0 kg , Input . Press  key to accept the entry 100.0 kg, the scale display  again.

Step 3: Press  key to set Minimum range value, the display will show

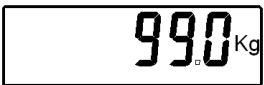
, Press  key the display flashes the last accept value entered. If a different accept value is desired, enter the new value via the numeric keypad (Data input method refer to section 3.3.4) . Example

99.0kg, input . Press  key to accept the entry 99.0kg, the scale display  again.

Step 4: Press  key to set checkweighing beeper signal.

.

This menu item is used to define when beeper sounds (an audible alert) during checkweighing.

Selections are:

none: No beep for checkweighing .

ok: Beep, when checkweighing between the limits .

FBx Series Indicator

ng: Beep, when checkweighing out of the limits



When choose one suitable way, press  key to confirm setting. After

setting the display return to show



Step 5: After confirming the parameters of checkweighing sequence,

press  key to exit the menu .Indicator returns to active weighing mode.

Step 6: Checkweighing Operation

Checkweighing is used to determine when the weighed sample is within the target range.

Checkweighing display warning

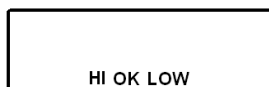

OK: weight is equal or within preset target range.

HI: weight exceeds preset maximum value.

LOW :weight is below preset minimum value.

In this example, target range settings are under 100.0 kg and over 99.0 kg.

Place the item to be weighed on the scale platform. The illustration indicates a sample weight of 99.5 kg. The indicator OK display indicates

that the weight is within the Accept range.

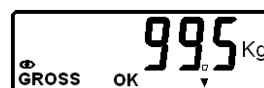

is displayed.

IF beeper signal





is set as



, beeper



sounds.



FBx Series Indicator

IF beeper signal  is set as  , beeper doesn't sound.

Place the item to be weighed on the scale platform. The illustration indicates a sample weight of 100.5kg. The indicator HI display indicates that



the weight exceeds preset maximum value.  is displayed.



IF beeper signal  is set as  , beeper sounds.

IF beeper signal  is set as  , beeper doesn't sound.

Place the item to be weighed on the scale platform. The illustration indicates a sample weight of 98.5kg. The indicator LOW display indicates



that the weight is below preset minimum value.  is displayed.

IF beeper signal  is set as  , beeper sounds.

IF beeper signal  is set as  , beeper doesn't sound.

Note: 1. Values entered can be from 20d to Full Scale capacity.

FBx Series Indicator

2. Press  key to accept the value entered. value displayed will be saved. When one parameter is setted, press  key to set next parameter.
3. Minimum range value cannot be greater than maximum range value.
4. If a container is used, press  key to tare it first.

3.7.4 Counting

This mode is used to count the quantity of items with the same weight. The quantity shown is based on the average sample weight.

To achive accurate results, the weight of each counted items must be consistent.

Count Procedure:

1. Press  to turn on the scale.

Wait for "0" to appear on the display.

2. Start the Count Procedure

If necessary, press  key to set the display to "0".

3. Place a given number of samples of an item on the platform (the Sample Size should be either 5、 10、 20、 50 、 100 or 200 pieces). The weight of these samples will show on the display.

FBx Series Indicator

4. Press  key to put the scale in counting mode.

5. Select the sample size (the same as you chose above) by pressing the



key (press it as many times as necessary to put it in the correct sample size ,the sample size is the same as in step three = 5、 10、 20、 50、 100 or 200.)

The Sample Size is five, please select

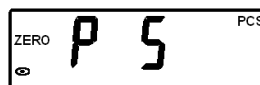

The Sample Size is ten, please select

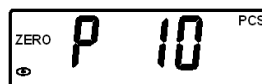

The Sample Size is twenty, please select

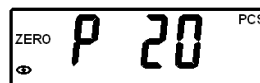

The Sample Size is fifty, please select

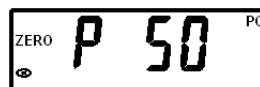

The Sample Size is one hundred, please select

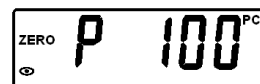

The Sample Size is two hundred, please select

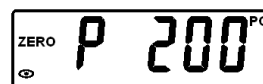

6. Wait for the stable indicator  to be displayed, press the  key

and the display will show

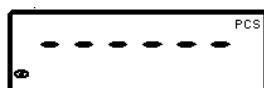

After 2 seconds, the display will return to “selected pcs” (Example the Sample Size is one hundred,

the display will show

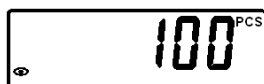

at this time) . The scale will

remember the sample size you selected and show the starting sample size

on the display (you can now remove the samples if you want to return the

scale to 0).

7. Place the items that you want counted onto the platform and the total number of items will show on the display.

8. Press the  key to exit the counting function and return to normal

weighing or you can press  key to turn the scale off to exit.

Counting Precautions:

1. The larger quantity of sampling is available, the more exact result will get. 1/4 of the total number is chosen as sample quantity generally.

2. The weight of unit sample $> 1/4d$, otherwise the display will show

counting error .

3. Place the counted items on the platform and wait for the stability

indicator  to be displayed.

If the counted items are placed in the container, please ensure to tare first.

4. After sampling, put a small amount of the same items to test whether the counting is accurate or not,

If not, please resampling again.

5. The count weight can't exceed the capacity. Otherwise the scale will

display overload . Please immediately remove extra items to avoid damaging the scale.

4. CARE AND MAINTENANCE

4.1 Calibration

When the FBx Indicator is initially set up to a base, it must be calibrated before use to ensure accurate weighing results.

Before you Begin:

1. Make sure that appropriate calibration masses are available before beginning calibration.
2. Make sure that the scale is level and stable during the entire calibration process.
3. Calibration is unavailable with J13 interface is not shorted CAL

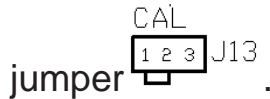

4. Allow the scale to warm up for more than thirty (30) minutes after stabilizing to room temperature.

5. To abort calibration, press  key anytime during the process.

Important: The instructions below continue from the section above, so the indicator should already be in programming mode.

4.1.1 Any Value Calibration (AnyCal)

AnyCal Calibration uses two points to adjust the scale. One point is called the zero value where there is no weight on the scale.

The other point is any value that can be set, but it is recommended that the value is not less than half of the full capacity. The value closest to the full capacity is recommended to give the best performance over the entire weighing range.

Follow the steps below to calibrate the FBx indicator:

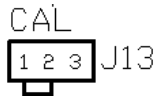

Step 1: To enter the parameter menu mode:

- Open the indicator housing. Shorting the CAL jumper of J13 on the main

PC board. See .

- Press  key to turn on the indicator, the system will enter the self checking mode.



FBx Series Indicator

- Press  key during  appears on the display, the display will show . The CAL arrow is lighted until the CAL jumper of J13 is removed.

Press  key to select the setting menu in menu mode.

Press  key to allow entry into the displayed menu.

Press  key to exit the current setting menu.



Step 2: Press  key when  appears on the display, the display will show . This means the system enter the CAL setting menu.

This menu item is used to set the full capacity and main unit of the scale.

Press  key to select the main unit lb or kg.

If a different full capacity value is desired, enter the new value via the numeric keypad. Please refer to section 3.3.4 about how to input data.

FBx-C counting indicator can use numeric keypad, FBx-W weighing

indicator can use  key to add 1 and  key to shift 1.

Values entered refer to Appendix D for typical values.

FBx Series Indicator



Step 3: The full Capacity and main unit are set, press  key to confirm

the setting. The display will show .

This menu item is used to set the calibration weight and calibration unit.

If a different calibration weight is desired, enter the new value via the numeric keypad. Please refer to section 3.3.4 about how to input data.

FBx-C counting indicator can use numeric keypad, FBx-W weighing

indicator can use  key to add 1 and  key to shift 1.

Press  key to select the calibration unit lb or kg.

Note: Calibration value range from 1 kilogram or 1 pound to 100% full scale are accepted. Suggest that value range is not less than half of 100% full capacity. Note that values closer to the full capacity will usually yield the most accurate calibration.

Step 4: Calibration weight and unit are set, press  key to confirm the

setting. The display will show .

This item is set the division. The unit shown is the main unit that is set in front.

Selections are: 0.002 /0.005 /0.01 /0.02 /0.05 /0.1/ 0.2 /0.5 /1 /2 /5 /10.

After setting the division, the scale will enter the calibration.

FBx Series Indicator

Set capacity, main unit , calibration weight, calibration unit and division in sequence. Refer to 3.6.

Step 5: The division is set, press  key to confirm the setting. The display will show a series of digits known as the A/D value.

For example , these numbers will continuously move.

Step 6: Once the display shows the stable indicator "👁️", press the  key, the display will show the calibration weight that you entered in the upper step 3, flashing.

Step 7: Place the corresponding mass on the platform, after 2 seconds, stable indicator "👁️" is displayed, then press the  key the scale will calibrate.

If calibration was successful, the calibration weight is displayed and the scale automatically return to the weighing mode. Remove the mass and begin weighing operations.

If calibration fails, please press  key to return, then to check if parameter setting is correct.

Step 8: Turn off the power, then turn on the power again, place a known weight on the platform to verify if it is accurate.

Step 9: If the weight displayed does not correspond with the value of the calibration weight, please repeat above steps.

FBx Series Indicator

Step 10: After calibration is completed, open the CAL jumper of J13, re-install the front cover and make sure the liquid-tight connector is tight.

Menu flow chart is shown below

FBx Series Indicator

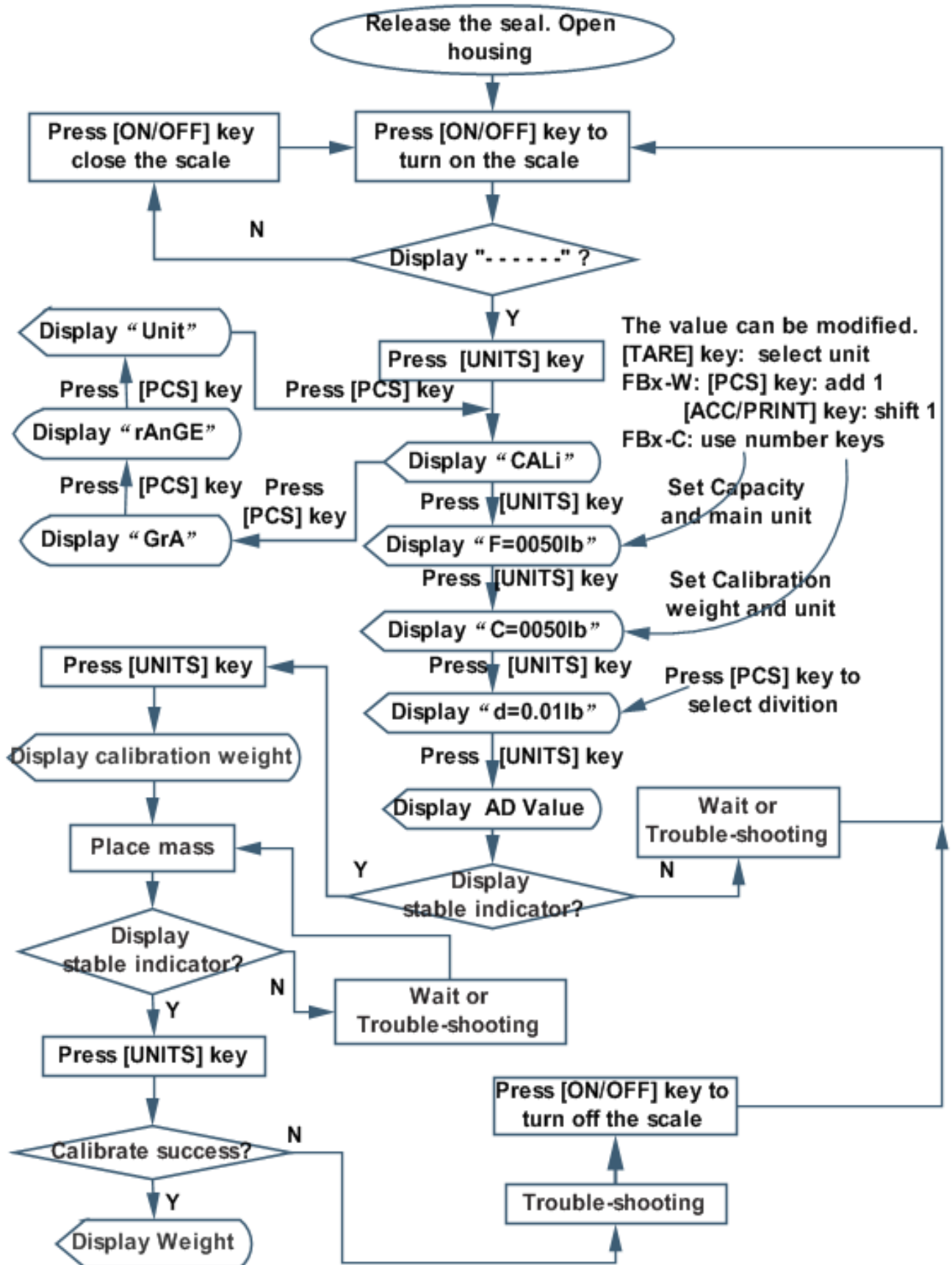

4.1.2 Gravity

FBx Series Indicator

This menu item is used to compensate for slight variations in gravity at different geographical locations around the world. The world's major cities gravity are listed in Table 4-1.

Prior to calibration, the gravity is set to correspond to the geographical location where the calibration is being performed. Following calibration, the gravity is changed to match the location where the scale is to be used. If required, the scale may also be sealed according to the required approval regulations.

Note: Only an authorized manufacturer's representative or certified verification personnel should make these changes. Changing the gravity alters the calibration values.

Table 4-1 World-Wide Acceleration Of Gravity Value

COUNTRY 国家	CITY 城市	G(m/sec ²) 加速度
China 中国	BeiJing 北京	9.8015
China 中国	ShangHai 上海	9.7946
China 中国	GuangZhou 广州	9.7883
China 中国	FuZhou 福州	9.7904
China 中国	HangZhou 杭州	9.7936
China 中国	NanJing 南京	9.7949
Scotland 苏格兰	Glasgow 格拉斯哥	9.816
Spain 西班牙	Madrid 马德里	9.800
Singapore 新加坡	Singapore 新加坡	9.781
Argentina 阿根廷	Buenos Aires 布宜诺斯艾利斯	9.797

Table 4-1 World-Wide Acceleration Of Gravity Value(Continued)

FBx Series Indicator

COUNTRY 国家	CITY 城市	G(m/sec²) 加速度
UnitedKingdom 英国	London,Greenwich 伦敦	9.812
Australia 澳洲	Melbourne+墨尔本	9.800
Australia 澳洲	Sydney 悉尼	9.797
Italy 意大利	Milano 米兰	9.806
Italy 意大利	Rome 罗马	9.803
India 印度	Calcutta	9.788
Japan 日本	Tokyo 东京	9.798
Canada 加拿大	Ottawa 渥太华	9.806
Canada 加拿大	Vancouver,BC 温哥华	9.809
Cuba 古巴	Havana 哈瓦那	9.788
Kuwait 科威特	Kuwait 科威特	9.795
South Africa 南非	Cape town 开普敦	9.796
Netherlands 荷兰	Amsterdam 阿姆斯特丹	9.813
Norway 挪威	Oslo 奥斯陆	9.815
New Zealand 新西兰	Auckland,NZ 奥克兰	9.799
New Zealand	Wellington,NZ 惠灵顿	9.801
Taiwan 台湾	Taichung 台中	9.789
Taiwan 台湾	Taiwan 台湾	9.788
Taiwan 台湾	Taipei 台北	9.790
Denmark 丹麦	Copenhagen 哥本哈根	9.815
Greece 希腊	Athens 雅典	9.800
Mexico 墨西哥	Mexico City 墨西哥城	9.779
Germany 德国	Frankfurt 法兰克福	9.810
U.S.A 美国	Chicago 芝加哥	9.803
U.S.A 美国	Los Angeles 洛杉矶	9.796
U.S.A 美国	Birmingham 伯明翰	9.813

4.2 Troubleshooting

FBx Series Indicator

Table 4-2. Trouble Shooting.

Symptom	Probable Cause(s)	Remedy
Scale will not turn on	<ul style="list-style-type: none"> •Power cord not plugged in or properly connected. •Power outlet not supplying electricity. •Battery power used up. •Other failure. 	<ul style="list-style-type: none"> •Check power cord connections. Make sure power cord is plugged in properly into the power outlet. •Check power source. •Connect AC power to charge the battery. •Service required.
Cannot zero the Scale, or will not zero when turned on.	<ul style="list-style-type: none"> •Load on Scale exceeds allowable limits. •Load on Scale is not stable. •Load Cell damage. 	<ul style="list-style-type: none"> •Remove load on Scale. •Wait for load to become stable. •Service required.
Unable to calibrate.	<ul style="list-style-type: none"> •Calibration Menu is not set correctly. •J13 interface is not shorted CAL jumper •Incorrect value for calibration mass. •Load cell cord not plugged in or properly connected. 	<ul style="list-style-type: none"> •Set Calibration Menu correctly. Refer to section 4.1. •J13 interface is shorted CAL jumper •Use correct calibration mass. •Check Load cell cord connections. Make sure Load cell cord is plugged in properly into the Load cell outlet.
Cannot display weight in desired weighing unit.	Desired unit setting not set to On.	Enable desired unit in the Units Menu (refer to section 3.6.4).
Ould	Weight on platform exceeds scale capacity	Remove load on Scale.
Out2	<ul style="list-style-type: none"> •Load on Scale exceeds allowable limits. •Load cell cord not plugged in or properly connected. 	<ul style="list-style-type: none"> •Remove excess weight from the platform. •Check Load cell cord connections. Make sure Load cell cord is plugged in properly into the Load cell outlet.
unSt	The AD internal code unstable	<ul style="list-style-type: none"> •Waiting for stable , the scale will auto to zero. •Place the scale on a stable level surface and kept away from foreign matter.
Err-E	EEPROM Error	Service required.
FaiL	Average Piece Weight less Than one fourth of division	To resample again
Lo-bAt	Low battery	<ul style="list-style-type: none"> •Connect AC power to charge the battery. •If battery remains weak even after a full charge cycle, replace the battery.

4.3 Cleaning

FBx Series Indicator

To keep the Indicator and scale operating properly, the housing should be kept clean and free from foreign material.

- The components should be kept clean and free of excessive material build up.
- The platform can be cleaned using most standard food processing equipment methods (such as high-pressure water or steam)
- Do not use strong alkalis, solvents or abrasive materials and chemicals
- Removable components such as the weighing platform and rubber load pads (including column and FBx Indicator when purchased as a scale system) may be removed and cleaned

4.4 Service Information

If the Troubleshooting section does not resolve or describe your problem, you will need to contact an authorized Furi Service Agent.

An Furi Product Service Specialist will be available to help you.

4.5 Battery Replacement

The Indicator contains a small Lithium battery to maintain a real-time clock and a memory backup system. This battery should provide many years of maintenance free operation.

The FBx Indicator also has a rechargeable lithium battery. This battery allows operation of the Indicator without an AC power connection.

FBx Series Indicator

In the event that either battery requires replacement, please note the following safety precautions:

CAUTION : RISK OF EXPLOSION IF BATTERY IS REPLACED WITH WRONG TYPE OR CONNECTED IMPROPERLY. SEE SERVICE MANUAL FOR INSTRUCTIONS. DISPOSE OF BATTERY ACCORDING TO LOCAL LAWS AND REGULATIONS.

4.5.1 RTC battery replacement

Some symptoms of a low Real-Time Clock (RTC) battery condition include:

An incorrect time or date printout, loss of library or accumulation data.

Battery replacement should only be done by qualified service personnel.

To replace the lithium battery, the Indicator housing needs to be opened.

Before continuing, remove power from the scale and remove all external AC power connections to the Indicator. If the Indicator contains a

rechargeable battery , be sure that the  key is used to turn off the scale after removing the AC power plug.

CAUTION: ELECTRICAL SHOCK HAZARD. REMOVE ALL POWER CONNECTIONS TO THE INDICATOR BEFORE SERVICING OR MAKING INTERNAL CONNECTIONS. THE HOUSING SHOULD ONLY BE OPENED BY AUTHORIZED AND QUALIFIED PERSONNEL, SUCH AS AN ELECTRICAL TECHNICIAN.



The Real-Time Clock, (RTC) battery is a 3V lithium “coin” cell. The recommended battery type is CR2032. Refer to figure 4-1

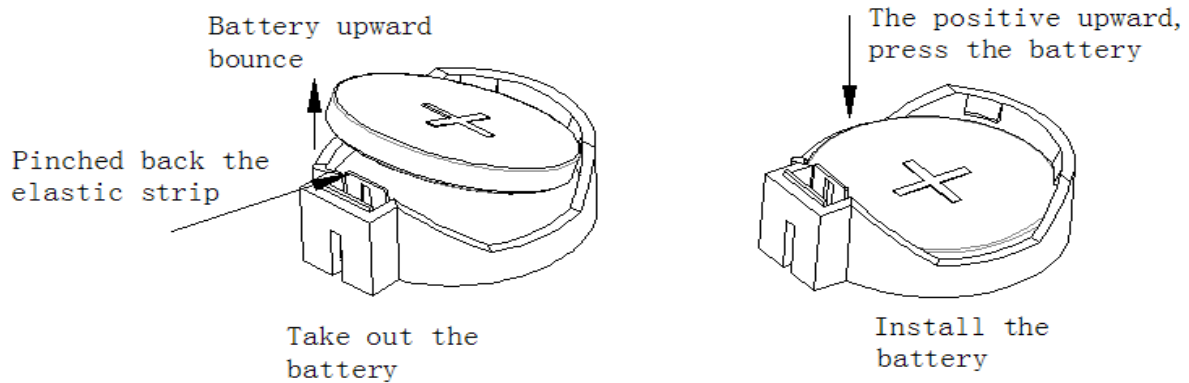



Figure 4-1. RTC Battery Removal/Installation.

To install a new battery into the holder, hold the battery with the “+” mark facing up.

4.5.2 Rechargeable Lithium Battery Replacement:

The lithium battery will work for a shorter time after a long-term use. When the scale can be used for a very short time even if it is recharged fully, a battery replacement is available from your dealer.

Note: 1. Do not dispose of used batteries in normal trash.  Follow the proper disposal or recycling requirements in accordance with local laws and regulations.

2. When the scale is used for the first time or a new battery is replaced, the battery should be charged fully.

If the scale is not used for a long time, please charge it every three months.

3. When the battery can not be recharged fully or works for a very short time after long-term use, please replace a new suitable battery in time.

5. TECHNICAL DATA

5.1 Drawings and Dimensions (Unit:mm)

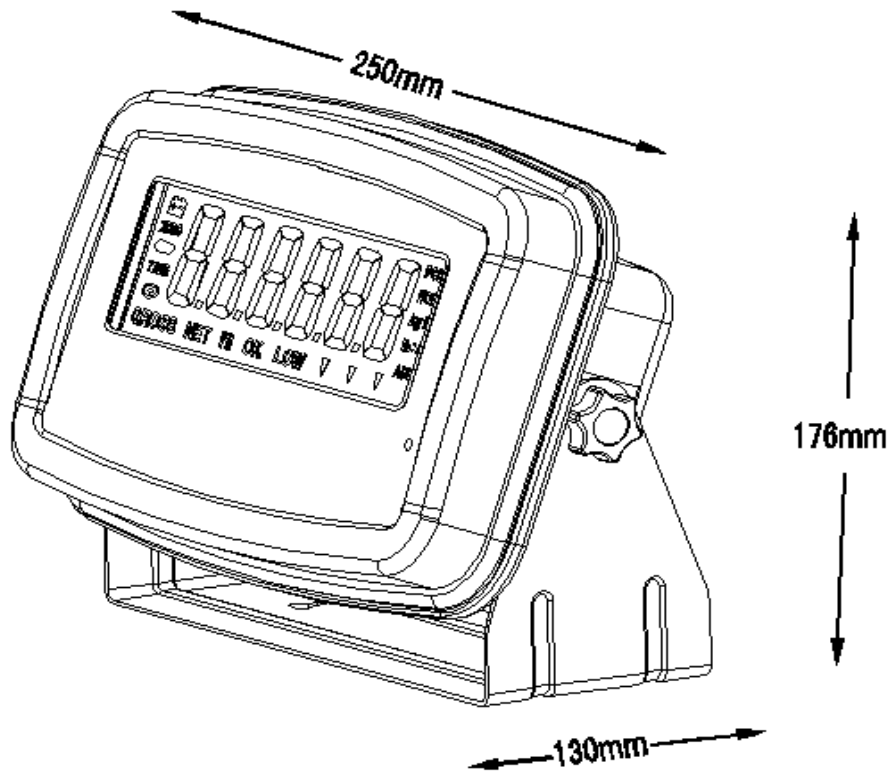

Figure 5-1. FBx Indicator Dimensions

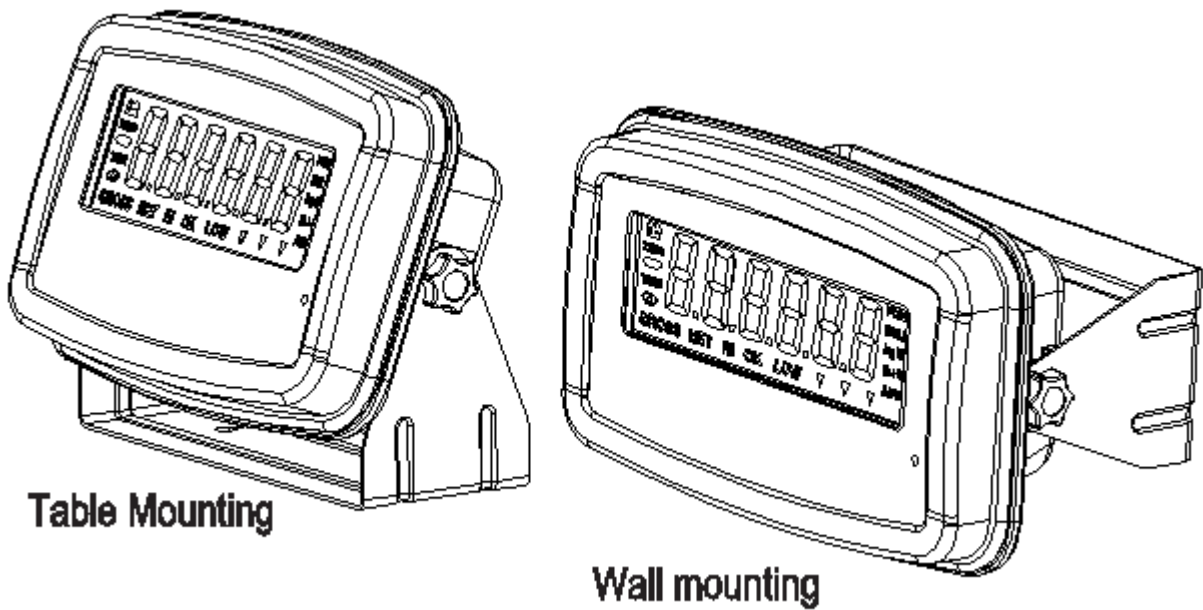

Figure 5-2. FBx Indicator Table/Wall Mount Position

5.2 Technical Data

Materials

Housing: Stainless steel

Keypad/display overlay: Polyester

Ambient conditions

The technical data is valid under the following ambient conditions:

Ambient temperature: -10°C to 40°C / 14°F to 104°F

Relative humidity: Maximum relative humidity 80% for temperatures up to 31°C decreasing linearly to 50% relative humidity at 40°C.

Height above sea level: up to 4000m

5.3 Specifications

Model	FB/FBS-W	FB/FBS-C
Description	Electronic Weighing Instrument	Electronic Counting Instrument
Accuracy grade	Class III	
n	5000	
Weighing Units	kg g lb oz(Can be set)	
Functions	Static Weighing, Checkweighing, Accumulation, Counting	
Weight Display	1.3" / 33 mm High 6-digit, 7-segment LCD	
Backlight	White LED	

FBx Series Indicator

Model	FB/FBS-W	FB/FBS-C
Keyboard	7-Function Buttons	8-Function,10-Numeric Buttons
Construction and Protection	Stainless Steel NEMA 4X / IP66	
Load Cell Excitation Voltage	DC 5V	
Load Cell Input Sensitivity	2 mV/V	
Stabilization Time	Within 2 Seconds	
Overall Dimensions (W x D x H) (inch / mm)	9.8inch × 6.9inch × 5.1inch / 250mm × 176mm × 130mm	
Net Weight (lb/kg)	3.7lb/1.7kg	3.7lb/1.7kg
Gross Weight (lb/kg)	4.4lb/2.0kg	4.4lb/2.0kg
Operating Temperature	-10°C to 40°C/14°F to 104°F	
Power	AC to DC Power Adapter : AC 100-240V 50/60Hz Input DC 12V 1000mA Output Internal Rechargeable Lithium Battery	

6. ACCESSORIES AND OPTIONS

Accessories and Options
Table/Wall Mounting Bracket
Table Mounting Kit
Wall Mounting Kit
Power Adapter
USB Cable (option)
RS232 Cable (option)

A. LEGAL FOR TRADE

Before this product can be used in legal-for-trade or legally controlled applications, it must be inspected in accordance with local Weights and Measures or approval agency regulations. It is the responsibility of the purchaser to ensure that all pertinent legal requirements are met. Please contact your local Weights and Measures office or authorized manufacturer's representative for further details.

Legally controlled operation can be secured using an internal hardware switch located on the PC board. Access to the hardware switch may be denied using additional mechanical methods. The scale must have been calibrated prior to performing this procedure.

FBx Series Indicator

This procedure must only be performed by authorized personnel.

Note: If the scale has been previously set for Legal For Trade operation, it will be necessary to remove the seal before proceeding. Removal of the existing seal will make the scale legally unusable for Legal for Trade use until a new seal is put into place.

A.1 Locking Metrological Parameters

Open the Indicator housing and short the CAL jumper. Set up the scale, and perform an accurate calibration. Refer to section 4.1 .

To prepare the scale for Legal for Trade operation, it is necessary to set the CAL jumper break. To operate the step, first remove all AC power from the scale system. On the scale containing a rechargeable battery , set the

scale Off using  key.



CAUTION: ELECTRICAL SHOCK HAZARD. REMOVE ALL POWER CONNECTIONS TO THE INDICATOR BEFORE SERVICING OR MAKING INTERNAL CONNECTIONS. THE HOUSING SHOULD ONLY BE OPENED BY AUTHORIZED AND QUALIFIED PERSONNEL, SUCH AS AN ELECTRICAL TECHNICIAN.

A.2 Verification

Prior to the mechanical sealing, the scale should be inspected for correct operation by an authorized Weights & Measures representative.

A.3 Sealing

Seal the Indicator as shown in Figure A-1:

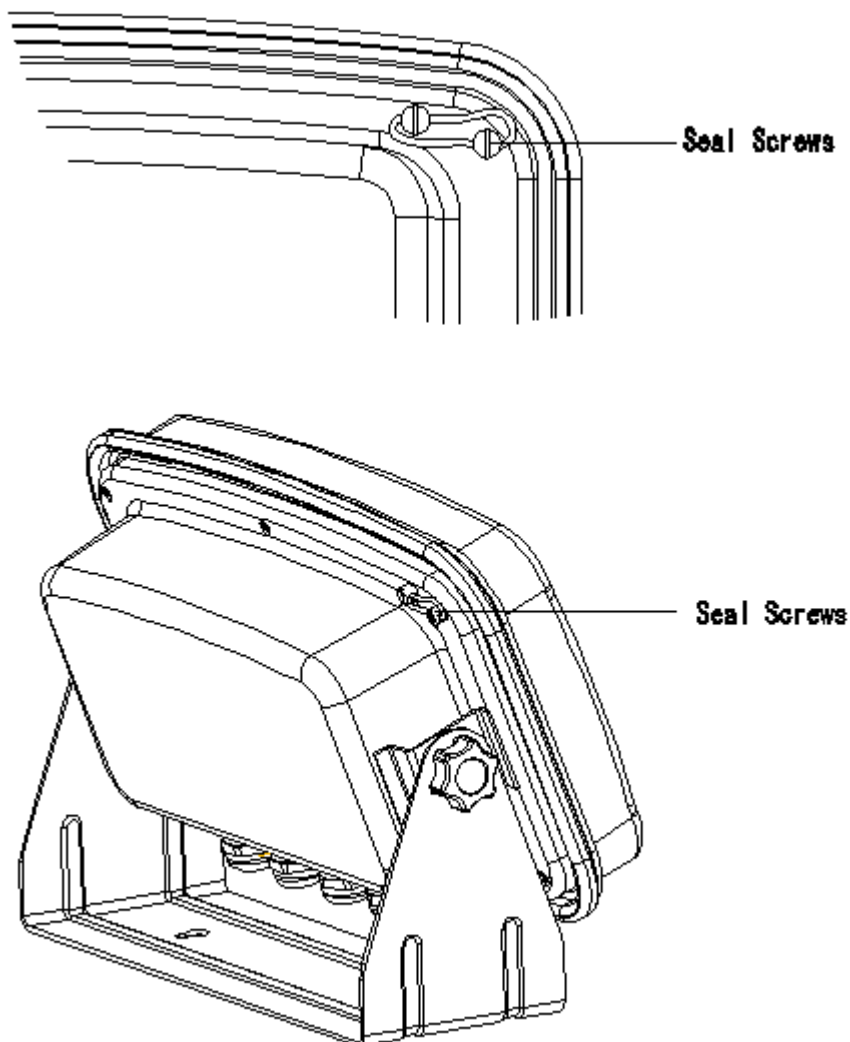

Figure A-1 External Seal

B. FBx INDICATOR MOUNTING

The FBx Indicator is supplied with a Table/Wall Mounting Bracket. The dimensions (unit:mm) as shown in Figure B-1.

The bracket allows the Indicator to be mounted to a vertical wall surface or to a table or other appropriate flat horizontal surface.

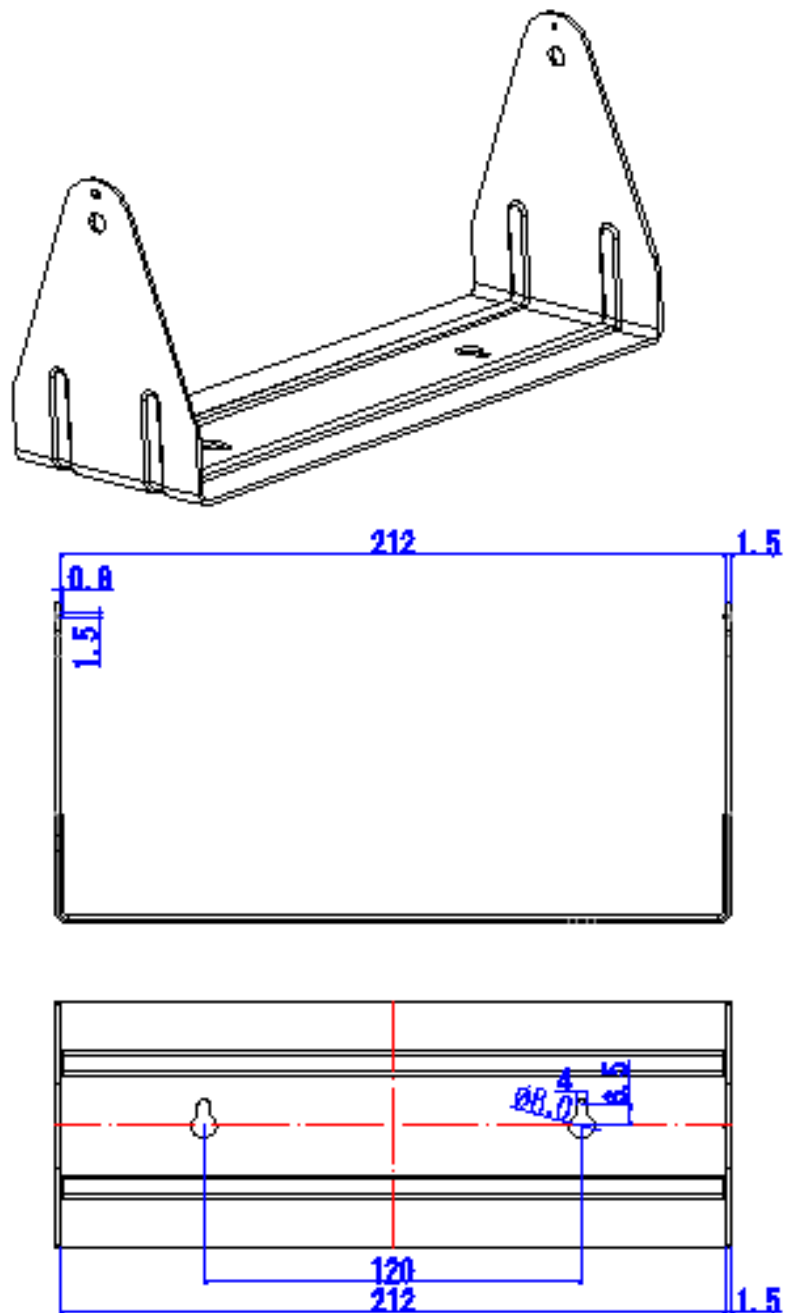

Figure B-1. Mounting Bracket

C. SERIAL COMMUNICATION

The FBx Indicator contains a RS232 serial communication interface. This interface gives the user a method to connect to a computer or printer. With this connection, the user can create printed records of weighing data and have some automated control over the Indicator's operation.

The interface uses a simple three-pin connection. RS232 operating parameters are more fully explained in section 3.5.2. The physical hardware connection is explained in section 2.3.1 .

C. 1 Interface Commands

The available RS232 commands are listed in Table C-1 below.

TABLE C-1. SERIAL INTERFACE COMMAND TABLE.

Command Description	Character
R	Read current weight
T	Same as pressing TARE key.
Z	Same as pressing ZERO key

C. 2 Output Protocol

The default RS232 output Protocol is shown below :

Weighing mode

		,			- / □							k	g	CR	LF
Header1		Header2		--Weight Data--							--Weight Unit--		Terminator		

Definition: -/□ : “-” denotes Negative , “□” denotes Positive

Header1: ST=Stable , US=Unstable
Header2: NT=Net , GS=Gross

Counting mode

P	C	S	:							□	p	c	s	CR	LF
				-- QTY --						--QTY Unit--			Terminator		

C. 3 Output Example

ST,GS,	0.948lb
2017-10-18	09:01
UN,GS,	2.025lb
2017-11-01	21:01
ST,NT,	0.816lb
2017-11-02	00:01
UN,NT,	1.508lb
2017-11-06	00:01

Stability indicator : "ST" when stable, "UN" when unstable.

"GS" means gross weight, "NT" means net weight.

FBx Series Indicator

Printout date : 2017-10-18

Printout time : 21:01

D. CAPACITY AND GRADUATION TABLE

Table D-1. Typical Capacity and Graduation Values

Model	Capacity	e_{min}	Platter size
FBx-m1212	50lb 800.0oz	0.01lb 0.2oz	12inch x 12inch
FBx-m1218	22.680kg 22680g	0.005kg 5g	12inch x 18inch
FBx-m1212	100lb 1600oz 45.36kg 45360g	0.02lb 0.5oz 0.01kg 10g	12inch x 12inch
FBx-m1218			12inch x 18 inch
FBx-m1620			16inch x 20inch
FBx-m1818			18inch x 18inch
FBx-m1824			18inch x 24inch
FBx-m1218	250lb 4000oz 113.40kg 113400g	0.05lb 1oz 0.02kg 20g	12inch x 18inch
FBx-m1620			16inch x 20inch
FBx-m1818			18inch x 18inch
FBx-m1824			18inch x 24inch
FBx-m2424			24inch x 24inch
FBx-m1620	500lb 8000oz 226.80kg 226800g	0.1lb 2oz 0.05kg 50g	16inch x 20inch
FBx-m1818			18inch x 18inch
FBx-m1824			18inch x 24inch
FBx-m2424			24inch x 24inch

Explanation of model designations: FBx-myyyy;

x: denotes the material

S indicates Stainless Steel and blank indicates Cast Steel;

m: denotes the indicator model

C denotes the indicator with number keys

W indicates the indicator without number keys;

where blank indicates scale structure model;

yyyy: denotes the platter size in inch

(ex-1218 indicates 12inch x 18inch);

LIMITED WARRANTY

Furi products are warranted against defects in materials and workmanship from the date of delivery through the duration of the warranty period.

During the warranty period Furi will repair, or, at its option, replace any component(s) that proves to be defective at no charge, provided that the product is returned, freight prepaid to Furi.

This warranty does not apply if the product has been damaged by accident or misuse, exposed to radioactive or corrosive materials, has foreign material penetrating to the inside of the product, or as a result of service or modification by other than Furi. In lieu of a properly returned warranty registration card, the warranty period shall begin on the date of shipment to the authorized dealer. No other express or implied warranty is given by Furi Corporation. Furi Corporation shall not be liable for any consequential damages.

As warranty legislation differs from state to state and country to country, please contact Furi or your local Furi dealer for further details.

Fuzhou Furi Electronics.,LTD

Warranty card

Customer service hotline : 86-591-83646863 ,83859705

After-sale service email : furi@cn-scales.com

Notice: Warranty card helps ensure equipment maintenance service.

Please save the warranty card carefully after opening the carton
and using our scale.

User name: _____

Address: _____

Contacts: _____ Tel: _____ Postcode: _____

Purchase Date: _____ Model Number: _____

Device number SNR _____ Invoice number: _____

■ Users must fill it in correctly for our file to facilitate maintenance
services.

FBx Series Indicator

■ We will provide maintenance service according to your warranty card and invoice.

Fuzhou Furi Electronics.,LTD

Delivery address: 37 Building, B zone, Pushang Park, Jinshan Industrial District, Fuzhou

Post code: 350008

Tel: 86-591-83646863 ,83859705

Fax: 86-591-87984861 ,83050562

Product standard code:

Technology subject to change without notice.

Welcome to visit our company website for more product information.

[http:// www.furiscale.cn](http://www.furiscale.cn)

E-mail: furi@cn-scales.com

FBx Series Indicator

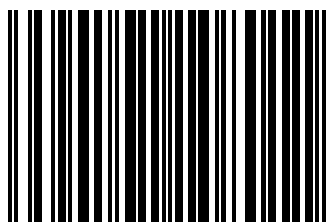

1990101E10801

P/N 1990101E10801 © 2016 Fuzhou Furi Electronics.,LTD property in copyright

No. 00000199 MADE IN FUJIAN