

US-X1LP

Software rev: V 1.00 & above

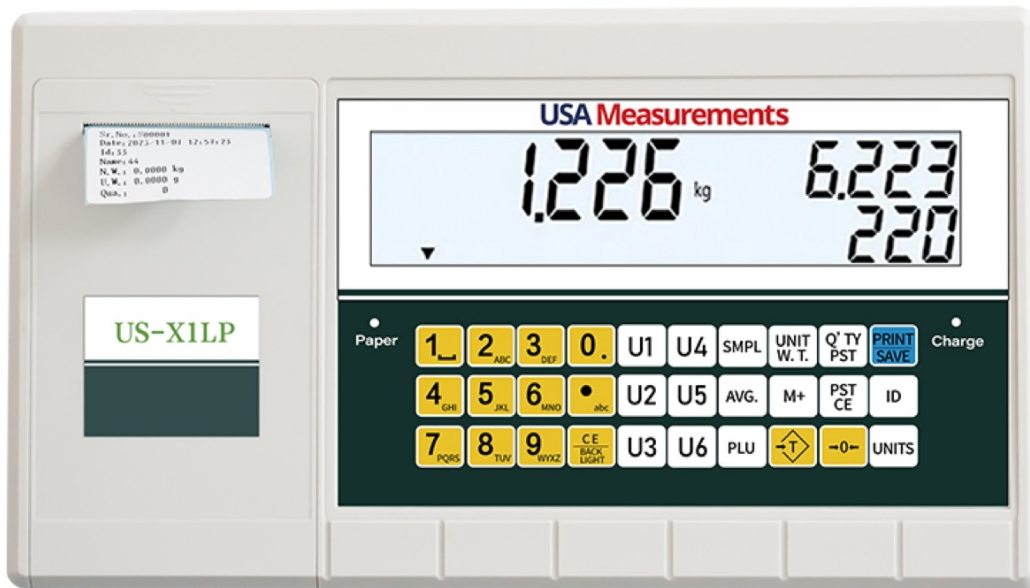

Easy Reference:

Model name of the indicator/scale:	
Serial number of the unit:	
Software revision number (Displayed when power is first turned on):	
Date of Purchase:	
Name of the supplier and place:	

Contents

PN: 7.00.6.6.0414 Rev B, July 2019

1.0	INTRODUCTION	3
2.0	SPECIFICATIONS	4
3.0	INSTALLATION	5
3.1	UNPACKING	5
3.2	LOCATING.....	5
3.3	CONNECTION.....	6
3.3.1	<i>Fixing the cable and the indicator</i>	6
4.0	KEY DESCRIPTIONS	7
5.0	DISPLAYS	8
5.1	WEIGHT DISPLAY	8
5.2	UNIT WEIGHT DISPLAY.....	9
5.3	COUNT DISPLAY	9
5.4	SYMBOL ICONS	9
6.0	OPERATION	9
6.1	ZEROING THE DISPLAY	9
6.2	TARING	10
6.2	CHECKWEIGHING.....	11
6.3.1	<i>Setting the checkweighing limits</i>	11
6.4	PARTS COUNTING.....	12
6.4.1	<i>The unit weight of object is unknown</i>	12
6.4.2	<i>The unit weight of object is known</i>	12
6.4.3	<i>Automatic update of unit weight</i>	12
6.4.4	<i>Accumulation/ Totalising</i>	12
6.5	SETTING THE PLU DATA	13
6.5.1	<i>Edit the PLU data</i>	13
6.5.2	<i>Input letter</i>	14
6.5.3	<i>Setting by PC (recommended method)</i>	14
7.0	USER PARAMETERS	16
7.2	SYSTEM PARAMETERS	18
8.0	CALIBRATION	20
8.1	SETTING CAPACITY AND DIVISION.....	20
8.2	CALIBRATION.....	22
9.0	LABEL PRINTING FUNCTION	23
9.1	LABEL EDITING COMPUTER SOFTWARE.....	23
9.1.1	<i>Label editor software interface</i>	24
9.1.2	<i>Operation method</i>	24
9.1.3	<i>Label customisation</i>	25
9.1.4	<i>Adding Text</i>	26
9.1.5	<i>Adding Photos</i>	26
9.1.6	<i>Adding Barcodes</i>	27
9.1.7	<i>Adding QR Codes</i>	28
9.1.8	<i>Deleting items</i>	28
9.2	LABEL DOWNLOAD PROCEDURE VIA RS 232 CABLE	29
10.0	RS-232 INTERFACE	29
10.1	INPUT COMMANDS FORMAT	31
10.2	REAL TIME CLOCK SETUP	32
10.3	AUTO SLEEP FUNCTION.....	32
11.0	BATTERY AND BACKLIGHT OPERATION	32
11.1	BATTERY	32
11.2	CHARGING.....	33
11.3	BACKLIGHT FOR LCD.....	33
12.0	ERROR CODES	34
13.0	REPLACEMENT PARTS AND ACCESSORIES	35
14.0	SERVICE INFORMATION	36
	WARRANTY INFORMATION	37

1.0 INTRODUCTION

The US-X1LP series provides a versatile check counting and weighing application perfect for general warehouse and production.

- The indicators can be set to verify counts up to 60000 divisions
- All indicators are supplied with a RS-232 bi-directional interface and real time clock (RTC).
- The indicator has a sealed keypad with colour coded membrane switches and there is a large, easy to read liquid crystal type display (LCD). The LCD is supplied with a backlight.
- The indicator includes checkweighing, percentage weighing and parts counting applications.

2.0 SPECIFICATIONS

INPUT SECTION	
Load Cells	8 at 350 ohm
Connection	4 wire, auto compensation for long distance ≤ 10 meters
Excitation	DC 5V: 1 ≤150mA
Sensitivity	≥0.02 μ V/e
Linearity	0.01% FS
Zero Range	0-10mv
Signal range	-20mV~20mV
A/D conversion method	Σ - Δ
DIGITAL SECTION	
Capacity	1-800000kg
Verified counts	1/30000-1/60000
A/D conversion speed	8 times/sec
Max. A/D conversion bits	24
Operating Temperature	0°C to +40°C / +32°F to +104°F
Power supply	AC 12V/3A; DC inside rechargeable 6V/10AH battery
Battery	Internal rechargeable battery
Calibration	Manual calibration
Display	3 displays showing 6, 6 & 7 digits
Indicator Housing	ABS Plastic
Overall Dimensions (wxdxh)	300x170x125mm
Net Weight	2.8kg/6pcs
Label sticker roll size	Wide=50mm, Diameter=80mm
Functions	Parts counting, weighing, percentage weighing, checkweighing, pre-set count with alarm
Interface	RS-232 bi-directional interface English, German, French, Spanish selectable text
Date/Time	Real Time Clock (RTC), To print date and time information (Dates in Year/month/day, Day/month/year or Month/day/year formats- Battery backed)





3.0 INSTALLATION

3.1 UNPACKING

This indicator must be connected to a load cell platform and calibrated as necessary to match the platform and user requirements.

The user's application and the technical specifications of the platform or load cell will determine the necessary configuration.

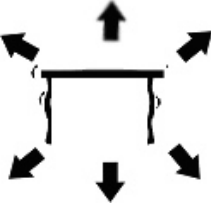
3.2 LOCATING

	<ul style="list-style-type: none">• The indicator should not be placed in a location that will reduce the accuracy.
	<ul style="list-style-type: none">• Avoid extremes of temperature. Do not place in direct sunlight or near air conditioning vents.• Avoid unsuitable tables. The table or floor must be rigid and not vibrate.
	<ul style="list-style-type: none">• Avoid unstable power sources. Do not use near large users of electricity such as welding equipment or large motors.• Do not place near vibrating machinery.• Avoid high humidity that might cause condensation. Avoid direct contact with water. Do not spray or immerse the indicator in water.
	<ul style="list-style-type: none">• Avoid air movement such as from fans or opening doors. Do not place near open windows or air-conditioning vents.• Keep the indicator clean. Do not stack material on the indicator when they are not in use.

3.3 CONNECTION

This indicator must be connected to a load cell platform and calibrated as necessary to match the platform and user requirements.

The US-X1LP has a connector configured for 4-6 wire load cells. Connect the load cells/platform to the indicator as shown below. The cable length should be as short as possible, using a large size wire to minimise errors due to resistance in the leads.

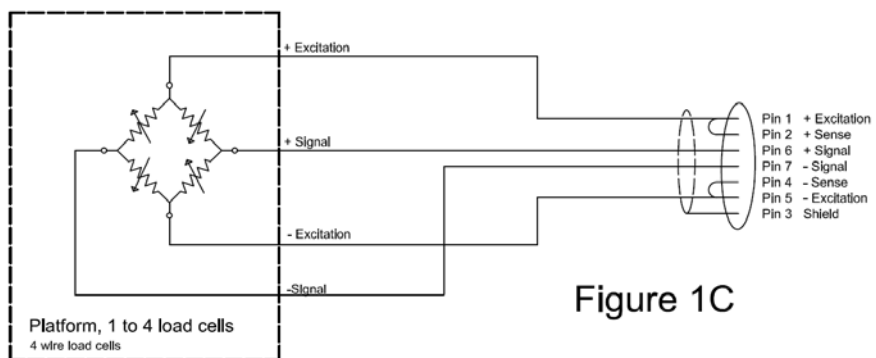
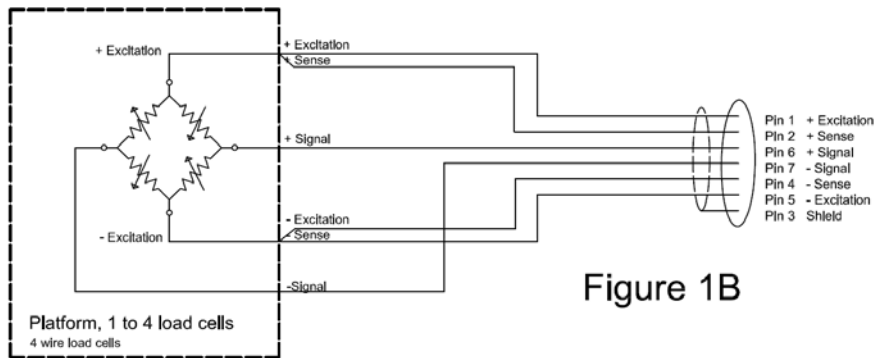
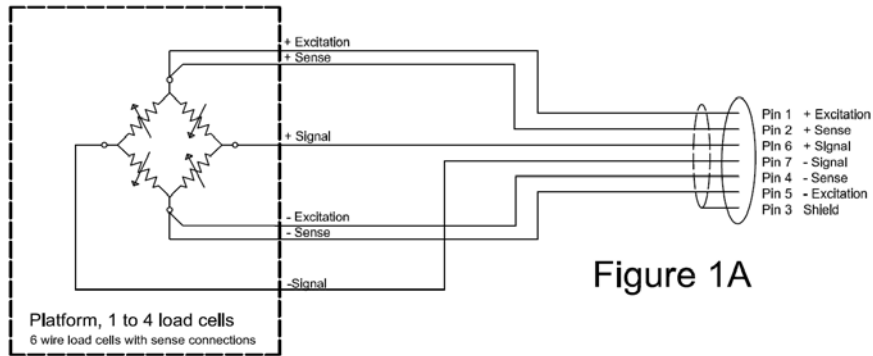



3.3.1 Fixing the cable and the indicator

Thread the cable through the pillar, then insert the pillar into the scale/ platform base, fasten the fixed screw, then place the cable through the holder. Insert the holder into the bracket of the indicator. Fix the load cell connector. Adjust the holder for right position, and then fasten the plastic screw on the display.

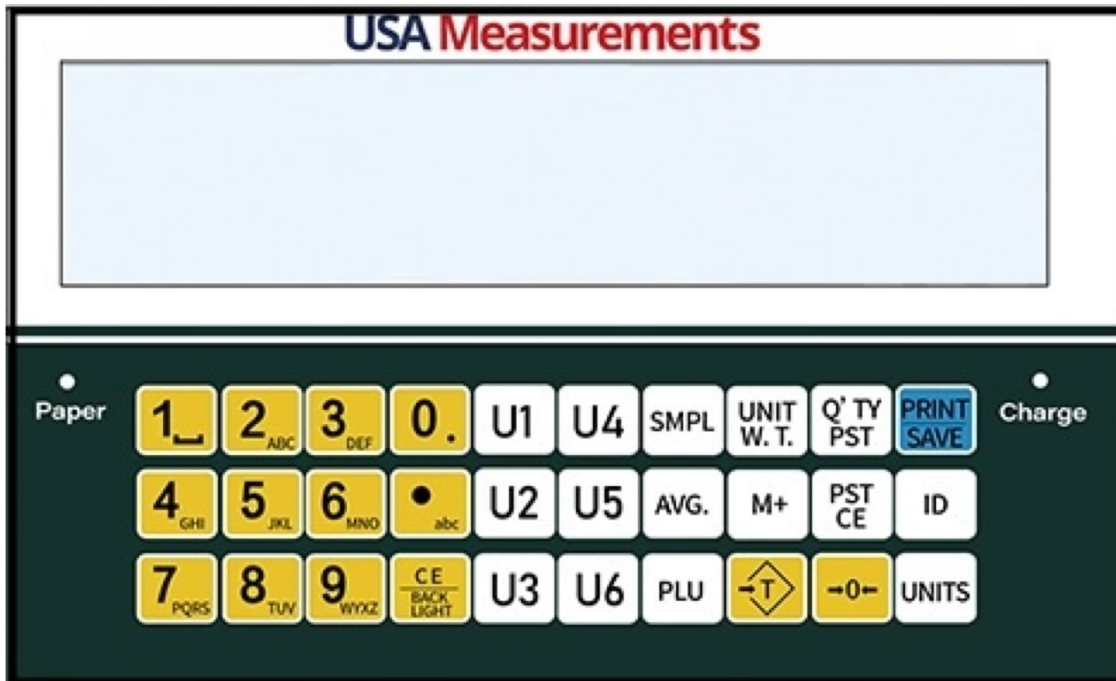
4.0 KEY DESCRIPTIONS

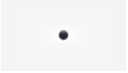

Keys	Functions
[0-9]	Numeric entry keys, used to manually enter a value for tare weights, unit weight, and sample size. Secondary functions: Used to type letters where necessary; used to add a decimal point.
[PST/ CE]	Clear the preinstall value.
[M+]	Add all the quantities and store, the max Total Number of Additions is 99.
[AVG.]	On/Off the automatic average function.
[QTY/ PST]	Preinstall the High/low Limit values.
[ID]	Press this key to enter the ID setting.
[UNITS]	Choose the units
[PLU]	Used to access any stored PLU weight values
[CE/ BACKLIGHT]	Used to clear numeric totals on the display. Secondary function: Allows the backlight to be configured to ON/ OFF/ AUTO
[U 1-6]	Fetch a stored PLU value directly

	Used to add a decimal point when entering a number on the display
[PRINT/ SAVE]	Print the total weight, unit weight, quantity of percent
[SMPL]	Used to input the number of items in a sample.
[UNIT W.T.]	Used to enter the weight of a sample manually.
 [Tare]	Tares the scale. Stores the current weight in memory as a tare value, subtracts the tare value from the weight and shows the results. This is the net weight. Entering a value using the keypad will store that as the tare value.
[→0←/ Zero]	Sets the zero point for all subsequent weighing to show zero.

5.0 DISPLAYS

The indicator features one LCD display separated into three. These are “**Weight**”, “**Unit Weight**” and “**Count**”.

5.1 WEIGHT DISPLAY

: Stability indicator

→0← : Zero indicator

Weight: The weight of goods.

Unit weight: The unit weight of goods.

Total Count: The total count of goods.

 Tare: Used as tare key in pricing mode

Lo-bat: When battery power lower than 5.6V, it will show.

Kg / Lb / g / oz : Symbols shown for the units

Net: Net weight- The scale has been tared





5.2 UNIT WEIGHT DISPLAY

This display will show the unit weight of a sample. This value is either input by the user or computed by the scale. The unit of measurement is grams if grams or kilograms is selected for the weighing unit, or pounds if pounds is selected.

5.3 COUNT DISPLAY

This display will show the number of items on the scale or the value of the accumulated count.

5.4 SYMBOL ICONS

- “Z” or Zero: “Zero” indicator “→0←”
- Tare:  “Tare” displays the deduction of the container weight.
- M+: “M+” Totaliser.
- If the piece weight is smaller than “Minimum Sampling Weight”, “” will be displayed. In order to clear the “” symbol, increase the size of the sample.
- If the piece weight is smaller than “Minimum Unit Weight”, “” will be displayed. The scale will still weigh even though the piece weight is too small, however this may affect the count accuracy.
- Press [Q'TY PST] key to enter the H/L Limit value for Quantity Preset in the weighing mode. “LIMOF” is used to configure the alarm settings, quantity or weight. In the unit weight Window, it will show “weight” or “count”, press [M+] key to change the alarm settings.

6.0 OPERATION

NOTE: US-X1LP only

SETTING THE WEIGHING UNIT, lb or kg

The indicator will turn on displaying the last weighing unit selected, either kilograms or pounds. To change the weighing unit press the [Units] key when the “Unit Weight” display shows zero. If necessary press the [CE] key to clear the unit weight before changing.

6.1 ZEROING THE DISPLAY

Press the Zero key to re-zero the display with no load on the weigh pan. If the balance was damaged or the weight is bigger than the range of the zero, this function will be inactive. It may be necessary to re-zero the scale over a period of time to account for minor drifting.

6.2 TARING

- Zero the scale by pressing the **[Zero/→0←]** key if necessary. The indicator “**→0←**” will be ON.
- Place a container on the platform and its weight will be displayed.
- Press **[Tare]** to tare the scale. Once the scale stabilises, it will display the net weight and the NET sign will be displayed.
- As a product is added, only the weight of the product will be shown. The scale could be tared a second time if another type of product was to be added to the first one. Again only the weight that is added after taring will be displayed.
- When the container is removed a negative value will be shown. If the scale was tared just before removing the container, this value is the gross weight of the container plus all products those were removed. The indicator “**→0←**” will also be ON because the platform is back to the same condition as it was when the **[Zero/→0←]** key was pressed last.

TARE WEIGHT IS KNOWN (PRE-TARE)

When the pan is empty, press **[Tare]** key, the display will show “**P - TARE**”. Input the weight of the container, press **[Tare]** key, Pre-tare complete. User can set follow function ON or OFF in F5 PTE:

In weighing mode, when tare weight is known, input tare weight, then press **[Tare]** key to Pre-tare.

Specific operation as follows:

Put the container and weights on the pan, input the container's weight and press **[Tare]** key, the weight window will show the net weight of the weights. Take away the container and weights, the weight windows will show a negative value. At this time, press **[Tare]** key to remove the tare weight value. Now, the weight window back to zero.

6.2 CHECKWEIGHING

6.3.1 Setting the checkweighing limits

To set the checkweighing limits ensure there is nothing on the scale/ platform and that the display shows zero.

- Press the **[Q'TY/PST]** key to bring up the checkweighing display. You should now see "LIMOF" then "**Weight**" or "**Count**" on the display, press the **[M+]** key in order to alternate between the two.
- Once selected, press the **[Q'TY/PST]** key to move to the next setting. "**CHLn0d H L**" should now appear on the display.
- Press the **[M+]** key to set the check alarm configuration, this will position a small dash on either side of the "**H**" and "**L**" or in between. (i.e. H-L, -H L, H L- etc).

There are 6 various customisable alarm options:

- H L	The beep is on when the weighing mass is more than the set high limit.
H - L	The beep is on when the weighing mass is between the set high and low limit.
H L -	The beep is on when the weighing mass is below the set low limit.
- H L -	The beep is on when the weighing mass is both more than and below the set limits.
- H - L	The beep is on when the weighing mass is in between the set limits and more than the set high limit.
H - L -	The beep is on when the weighing mass is in between the set limits and below the set low limit.

- Press **[Q'TY/PST]** to confirm and move to the next setting. "**LIM-Hi**" should now appear on the display with zero digits on the right of the display. Use the numeric keys **[1-9]** to manually enter the high check limit. Press **[Q'TY/PST]** to confirm.
- "**Lim-Lo**" should now appear on the display with the same zero digits on the right of the display. Use the numeric keys to enter to low limit and press the **[Q'TY/PST]** key to confirm.

6.4 PARTS COUNTING

6.4.1 *The unit weight of object is unknown*

Place a sample quantity of items on the scale/ platform, Enter the quantity of items by using the numeric keys on the indicator, then press the [SMPL] key. Once the scale stabilises, the quantity will show on the total quantity display and the balance will enter the counting mode automatically.

6.4.2 *The unit weight of object is known*

Enter the known weight of the item using the numeric keys on the indicator, Press the [UNIT W.T.] key, the quantity is shown on the quantity display and enter the counting mode automatically.

- The larger the sample weight is, the more accurate the quantity will be.
- With both the “Unit weight” and “Quantity” displays showing zero, pressing either the [UNIT W.T.] Key or the [SMPL] key will recall the latest piece weight value.
- When Press the [UNIT W.T.] key to get the unit weight, if the value which you place next time is more than 10% of the last sampling value and less than the last sampling value of present, the balance will automatically re-calibration the unit weight. User can set this function on /off in “F2 AVG”.
- If the unit weight and quantity all known, the balance will recalculate the unit weight according the quantity shows in the total quantity display when you press the [UNIT W.T].

6.4.3 *Automatic update of unit weight*

The scales will automatically update the unit weight when a sample less than the initial sample count is added. A beep will be heard when the value is updated. It is wise to check the quantity is correct when the unit weight has been updated automatically.

The user can turn this function ON/OFF by pressing the AVG key.

6.4.4 *Accumulation/ Totalising*

The totalising function can be used up to a maximum of 99 times before it must be reset. The totalising display is limited to seven digits maximum.

When the quantity is shown on the quantity display, Press [M+] Key, and then enters the totalising function. The quantity display shows “Add XX “, XX means the Total Number of Additions. After 3 seconds, the scale will return to the counting mode.

VIEWING ACCUMULATED DATA

When the weight window shows zero, press **[M+]** key to show the accumulative data. First, the scale will show total accumulative data as indicated by t – XX in the weighing window.

Press **[M+]** again, the scale will show all individual stored values as indicated by Add XX in the weighing window, followed by the stored amount. Press **[M+]** to view each stored value.

When the scale shows one of the stored values, press **[PST CE]** to delete the selected stored value.

When the scale shows all accumulated data, press **[PST CE]**, all accumulated data will be deleted.

In weighing mode, press **[PST CE]**, all accumulated will be deleted.

6.5 SETTING THE PLU DATA

In normal weighing mode, use number keypad to input PLU serial number, then press **[PLU]**, can get the weights name and unit weight of the corresponding weights. The display will show the item name once and back to normal weighing mode.

6.5.1 Edit the PLU data

In normal weighing mode, press and hold **[PLU]** key for 3s to enter PLU data edit mode.

The weight window shows “**set**”, user input the PLU number, then press **[PLU]** (or press “U1-U6” key directly), the weight window will show the input PLU number. Now, the scale enters into unit weight edit mode.

If this PLU number is already stored, the weight window will show the stored unit weight. If it is a new one, the weight window will show the unit weight which get in normal weighing mode. The user can edit the unit weight by using keypad.

Press **[PLU]** again to store the unit weight and enter SKU ID edit. User can use number and letter keypad to input. SKU ID can include letters, please check the step 6.5.2 for details on how to input. After inputting ID, press **[PLU]** to store. When finished, press **[CE]** to exit.

6.5.2 Input letter

Press **[.ABC]** once, there will have an arrow sign appear on the display point to “**ABC**”, or show an “**ABC**” sign on the display. This means enter to letter input mode.

Now, the user can input a letter by using the numeric keypad. Press **[2abc]** once, the display will now show “**A**” and blink, press once again, the display will show “**B**”, and so on. After the letter stops flashing, it means this letter has been inputted. To return to number input mode, press **[.ABC]**, the letter input sign will also disappear.

6.5.3 Setting by PC (recommended method)

Connect the scale with PC by RS232, open ScaleSetPlu.exe, and choose the right port.

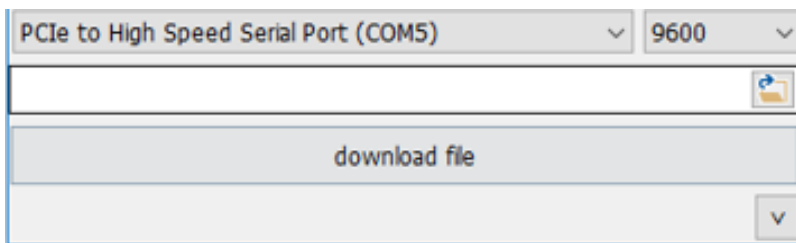

SINGLE PLU SETTING

Press , software will show

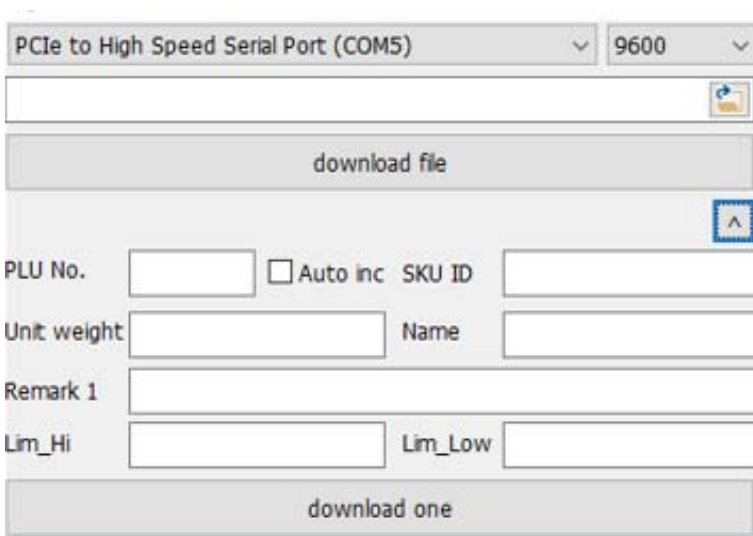

Input the serial number, unit weight, SKU ID, name as follow picture. if need scale increase the serial number automatically, please choose “Auto inc”.

PCIe to High Speed Serial Port (COM5) 9600

download file

PLU No. 1 Auto inc SKU ID JX001

Unit weight 2.55 Name 3X10 Screw

Remark 1 Remark

Lim_Hi Lim_Low

download one

Choose the right com port, Click **download one**, if this succeeds, this will show "Success".

Success!

The user can then set the next PLU.

DOWNLOAD MULTIPLE PLU BY TABLE (RECOMMEND)

Use table edit software (such as Excel, WPS, Numbers) to new built a file, then input PLU data by follow format:

A	B	C	D	E
pluid	Unit Weight	Sku Id	Name	Remark1
1	2.22	JB0031	3X8 Screw	12
2	7.99	JB0032	3X10 Screw	34
6	8.44	JB0033	4X12 Screw	56
7	4.22	JB0034	Cable 100mm	78
8	9.66	JB0035	Cable 120mm	
1001	3.88	JB0102	MCU XX	aa
1002	2.77	JB0104	MCU XXX	bbbb

plutest1.xls

Then save as xls file.

Excel 97-2003

1. In ScaleSetPlu.exe, click "Open"

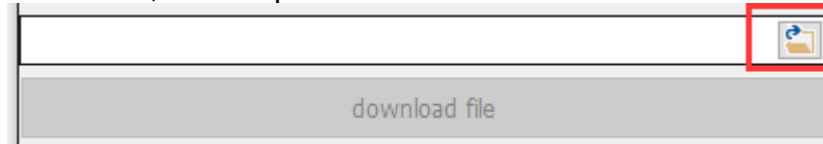

2. Choose the right com port, Click "download file"

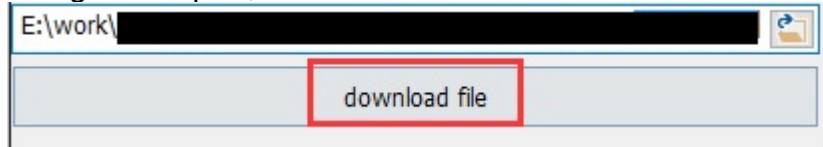

if succeed, will show "Success".

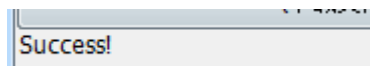

7.0 USER PARAMETERS

To access the user parameters menu when in normal weighing, press the **[PLU]** key and the **[CE/ BACKLIGHT]** key at the same time to enter the user parameter setting, the display will show the first parameter "**P1 TRA**", this is RS 232 communication setting.

In this menu, pressing the **[PLU]** key will enter the sub parameter setting. Alternatively, the user can press the number key that links to a corresponding sub parameter setting. For example, in "**T1 FC**", press **[3]**, the display will jump to "**T3 bps**". Press the **[M+]** key use to choose the right parameter options.

7.1 RS 232 Parameters

The RS232 parameters are divided into two categories: P1 TRA and P2 FUN.

P1 TRA – Communication settings

Parameter	Definition	Options
T1 FC	Communication mode: Continuous transfer mode, stable transfer mode and response.	1-6
T2 Add	Communication address, effective in multi-machine communication.	1-20
T3 Bps	Communication baud rate	2400, 4800, 9600, 19200, 38400, 56000, 115200
T4 Fmt	This parameter can be set to: n81 check bit/o71 data bit /e71 stop bit.	N81 O71 E71

T5 PFM	Label format. Set to 0, can print out the format which named FORMCOIN LP-50. For LP-50, please choose 0 or 1.	0-19
T6 Chk	Turn XOR check on or off.	
T7 FC2	Communication mode:	1-6
T8 PF2	Print functions	1-9

P2 FUN – Other function settings

Parameter	Definition	Options
F1 BL	For setting the backlight	ON OFF Auto
F1C SL	Setting the sleep time of the backlight in seconds.	1-45 seconds
F2 ARG	For setting the average unit weight function automatically.	ON OFF
F3 CST	Tare and zero stable waiting time.	ON OFF
F4 MAE	Turn ON/OFF next add up when not returning to zero after the previous add up.	ON OFF
F5 PTE	Set pre-taring ON/OFF when pre-inputting the tare value.	ON OFF
F6 UNT	Selecting the Weighing Unit	Kg, lb, oz, g
F7 FIL	Filter speed settings	ON OFF
F8 ZPE	To set if the scale can alarm when weight is 0.	ON OFF
F9 FAL	On means full alarm mode. OFF means simple alarm mode.	ON OFF
F10 BC	To set if the Hi-Lo relay runs after stable.	ON OFF

Press "ID" to escape and return to normal weighing mode.

7.2 SYSTEM PARAMETERS

To access system parameters, turn the indicator off, then press and hold down the CE/Backlight & PLU buttons, and turn on the indicator using the on/off rocker switch. The indicator will display CA:C3:-3 ----- Using the keypad key in 123456 & then press the PRINT key, repeated pressing of the PRINT key will cycle through the available options listed below:

Main- setting	Sub- setting	setting
CODE		Input new password. If user does not want to modify password, press [PRINT] to enter the next parameter.
P1 FIL { Filter }	F1 FIL	Filtering. Pressing the M+ key increases the intensity of the filter, the higher the filter value the more stable the weight reading is.
	F2 ZEO	Zero track parameter. If the zero point often moves, user can set this parameter. Pressing the M+ key increases the zero tracking filtering, however increasing this value may make it difficult to weigh small items.
	F3 ZTR	Creep tracking parameter. If the connected load cell suffers from creep, user can set the parameter. Pressing the M+ key increases the creep tracking filtering, however increasing this value may make it difficult to weigh small items.
P2 C-D {Capacity and division}	The unit weight window : CXXXX	XXXX is the capacity. If weigh is more than capacity+9 d, display will shows over load
	The total quantity window : DXXXX	Division value.
	dp xxx	Open or close the dual division.
	CU xx	The unit of capacity and calibration.
P3 LIN X { Multi-range calibration }	User can set multi-range calibration on/off here. Note : If user does not want to use the multi-range calibration, please set X off. If choose on, please remove all the weights from the pan before doing multi-range calibration.	
	LINEX	The state of multi-range calibration, X can be 1, 2, 3, it means setting step. Input the weights value, the put the right weights to calibrate. Remark: In the second step, value of weights must bigger than the first step, and in the third step, value of weights must bigger than the second step.

P4 CAL	The total quantity window : WEIXXXX	Use number key to input the weight value, XXXX is the value of the weights for calibration. Press [PLU] to enter the calibration. The display will show the A/D value, with no weight on the top pan press the PLU key when the stable indicator is showing
	The unit weight window : LOAD The total quantity window : XXXXX	In this step, put on the correct weight, after stable indicator appear, press [PLU] can complete calibration.
P5 EC	Calibration parameter record. User can review or use it for setting. When calibration parameters are lost, user can use this record to calibrate without weight. Note – we would recommend using P4 Cal setting and doing a fresh calibration as this is the best method	
	P1 Rul	Calibration parameter (the number is in the unit weight window, this value affects the weighing accuracy directly. Please note down this parameter after calibration. When this parameter lost, user can input the value by number key which been noted to calibration without weight. Press [M+] key, the digit of total weight window will keep blinking. Then input the value and press [PLU] to store and enter to another parameter.
	P2 Ld0	This is the calibration parameter is for multi-range calibration. (If user did not do multi-range calibration; do not need note this parameter. But need set P3 to OFF.) how to use and set this parameter, it is the same as standard calibration.
	P2 Ld1	The same as Ld0.
	P2 Lr0	The same as Ld0.
	P2 Lr1	The same as Ld0.

8.0 CALIBRATION

8.1 SETTING CAPACITY AND DIVISION

To set up the capacity and division follow the procedure below:

- With the indicator turned off, press and hold down the **[PLU]** and **[CE/Backlight]** keys and then turn the scale on using the rocker switch at the right back hand side of the indicator. The display will show:

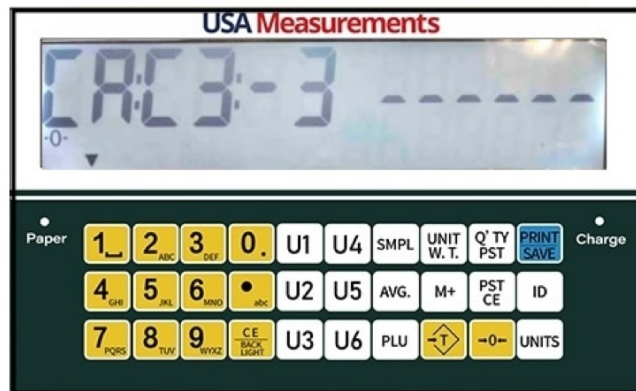

- Enter 123456 – which is the default passcode and you should see the following screen:



- Press the **[Print/Save]** button, this will take you into the system parameters (**P1 FIL** is to do with filtering) , press the **[Print/Save]** button again, and you should see the system parameter for settings capacity & divisions (**P2 C-d**), screen should look similar to as follows:

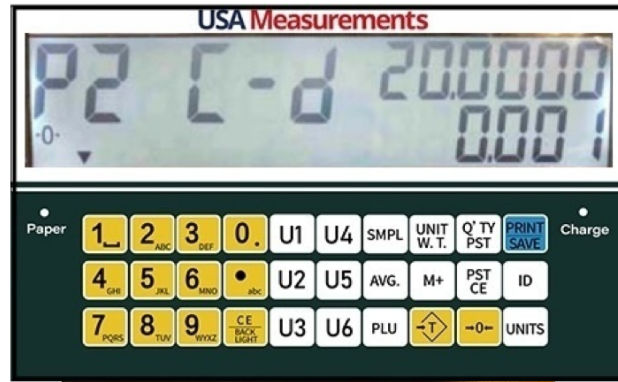

In the above example you can see the capacity is set for 20kg x 1g.

- To increase the capacity by 10 press the **[M+]** key; the capacity reaches a maximum by continuing pressing the **[M+]** key and then returns to the lowest point.
- Pressing the **[Zero/→0←]** key increases the flashing capacity value to various pre-set values, pressing the **[Tare]** key decreases the flashing capacity value.
- Once you are happy with the capacity value being correct, press the **PLU** key. The indicator has fixed divisions that can be set, but these are all normal multiples. To change the flashing division value press the **[M+]** key, repeated pressing of the **M+** key cycles the values round again.
- Once you are happy with the division, press the **PLU** key, you will then see the following screen:



- The flashing **dp**, refers to dual division; leave this set to off and press the **PLU** button to move to setting calibration unit which is shown as **CU kg** – this is the weighing unit for calibration. To change the weighing unit from kg to lb press the **[M+]** key.
- To move to the next parameter group setting press **[Print/Save]** key. The parameter shown on the display is **P3 LIN** (multi range calibration) – leave this set to OFF; if it is set to ON pressing the **[M+]** key toggles the setting.
- Press the **[Print/Save]** key to go to calibration -**P4 CAL**

8.2 CALIBRATION

The calibration display should look as follows:



- To calibrate the base, make sure the load cell cable is plugged into the back of the indicator, where it is labelled up load cell, the scale base is level, and there is no weight on the top pan.
- Enter the weight you wish to calibrate the scale using the Green keys; you can use the **abc** button to add a decimal point to the calibration value. Pressing the **[CE/backlight]** button clears any entered value. Press the **PLU** key to show the zero A/D counts; when the stable indicator is showing press the **PLU** key to accept the zero point.

The screen should look similar as follows:



- Load the weight you wish to calibrate with on the top pan, and press the **PLU** key. You should see Pass on the display, and then the indicator will return to normal weighing.

NOTE: US-X1LP indicators will have the lb or kg indicator on, to show the unit of the weight requested. If the scale was in pounds before starting the calibration, the weights requested will be in pound values or if the scale was weighing in kilograms then metric weights will be requested.

9.0 LABEL PRINTING FUNCTION

- In normal weighing mode, press **[Print/Save]** to print through built in label printer. Printing can also be done through RS 232 connectivity.
- Labels can also be printed via the built-in printer when in the accumulation recall function and in parts counting.

9.1 LABEL EDITING COMPUTER SOFTWARE

The US-X1LP is supplied with RS-232 interface which allows for connection between computer and indicator to edit labels for the inbuilt label printer and set printing parameters.

9.1.1 Label editor software interface

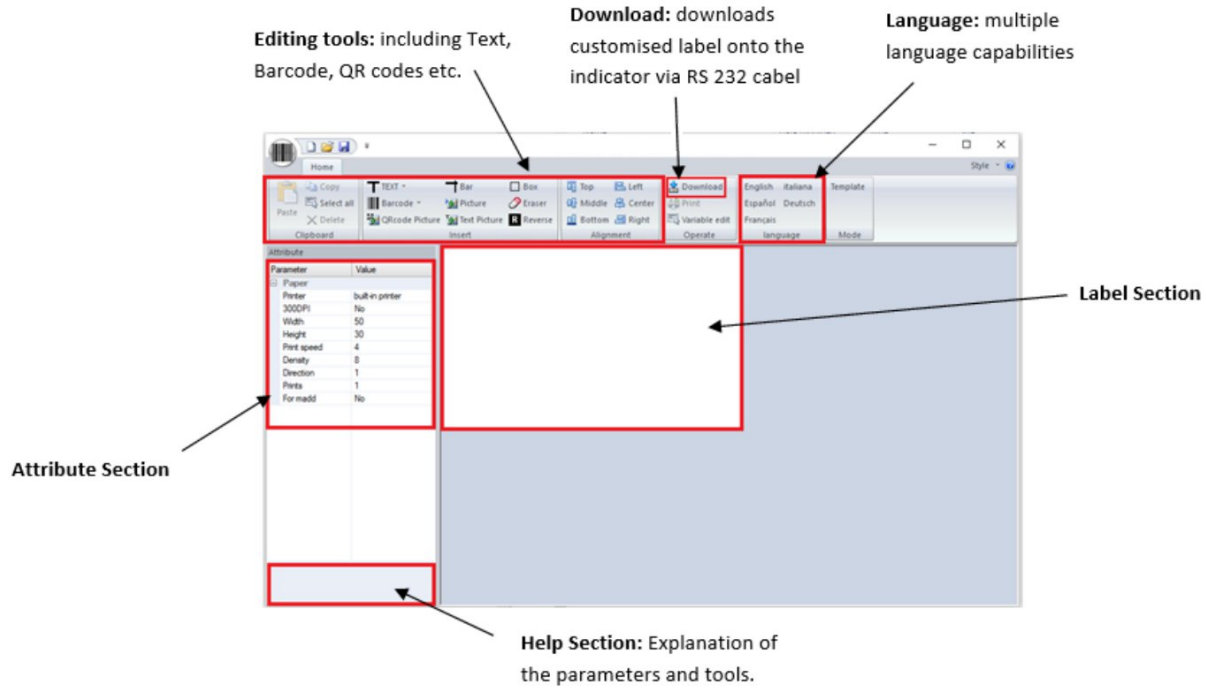

9.1.2 Operation method

- (1) Connect the indicator to the PC using the RS 232 cable provided, this is so the customised label can be downloaded straight to the indicator after completion
- (2) Start up the label editing software

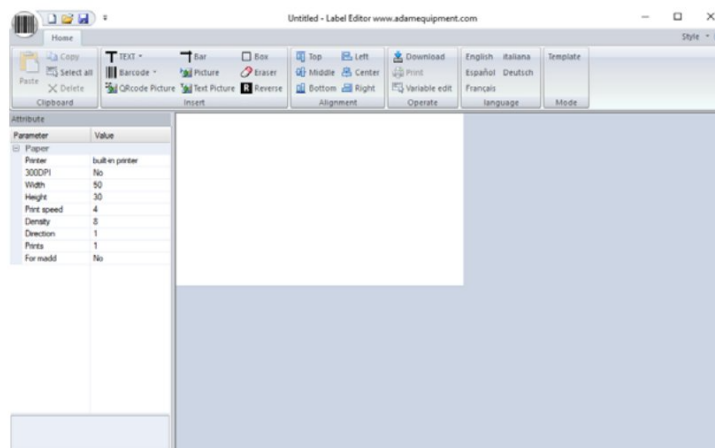

- (3) Press the barcode icon in the top left-hand corner, the following menu will be displayed:

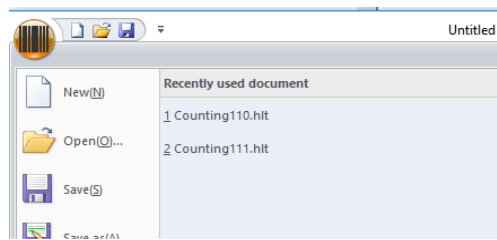

From here select to start a new label design, open a previously saved template or save a template to your PC

- (4) Set the parameters.

Attribute	
Parameter	Value
[-] Property	
Printer	built-in printer
Width	400
Height	240
Print speed	4
Direction	0
Prints	1
For madd	No

Printer: Chose the type of printing method (Default: built in printer)

Width: Length of label (unit is dot, 8 dot = 1mm, 400 dot = 50mm)

Height: 400 dot = 50mm

Print speed: The default value is 4

Direction: Print direction, 0 is positive, 1 is negative

Prints: How many labels will be printed when the print button is pressed

To change the parameters, left click the desired parameter and a drop-down arrow will appear with different options to select from.

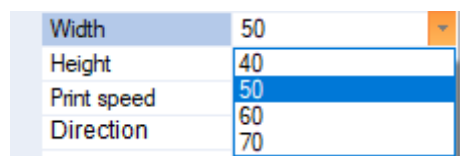

9.1.3 Label customisation

Once parameters have been set, the label can be customised and edited to the desired preference.

9.1.4 Adding Text

Various data can be added onto the label in which the text can be customised.

- Left click the TEXT icon and the drop down will appear.
- Left click on any variable to add to the label. For example net weight.

12.34 kg

- Net weight will appear on the label as:
The added information can be moved and place anywhere on the label by clicking and holding down.
- The text can also be further customised in the parameter section on the left-hand side.

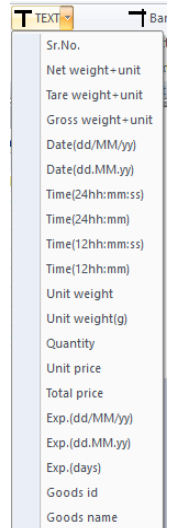

Attribute	
Parameter	Value
Property	
X	17
Y	20
Font size	3(12x24)
X Zoom	1
Y Zoom	1
Rotation	0
TEXT	N.W.(7)Unit

- Taking the net weight example:
- To add text, click the "TEXT" parameter on the left hand side of the display.
- Add the desired text into the box.

12.34 kg

TEXT N.W.(7)Unit

Rotation	U
TEXT	N.W N.W.(7)Unit

N. W 12.34 kg

9.1.5 Adding Photos

- Pictures can be added to a label design, the pictures will show as a black and white picture. To add a picture, left click the picture icon in the editing tools section.
- The picture will appear as a small icon before uploading the image file via the parameter settings section.

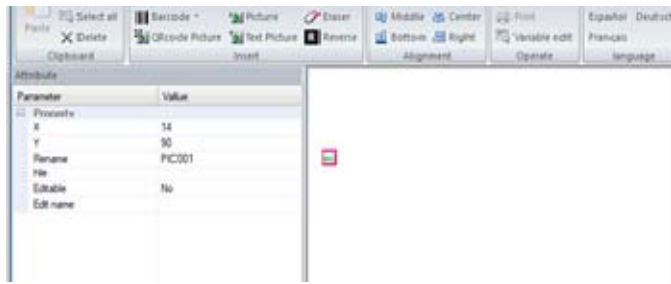

X: 8 = 1mm, 500=50 mm

Y: 8 = 1mm, 400 = 50mm

Rename: Rename picture, if there are pictures with the same name from previous labels they may be replaced

File: left click on the 3 dots that appear to select the picture to put on the label

Editable: whether the part of the template editing mode can be edited

- Text images can also be added to the label design, follow the same procedure as above by pressing the 'Text picture' icon in the editing tools section and add text in the 'TEXT' section.

9.1.6 Adding Barcodes

Bar codes can be added to the label which are capable of holding various weighing data.

- Left click the arrow next to the barcode icon and select the information for the barcode to hold, the barcode will then be added to the label.

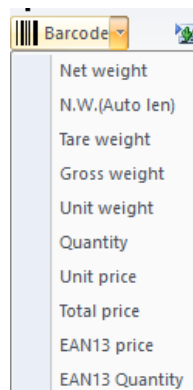

The barcode also has customisable parameters:

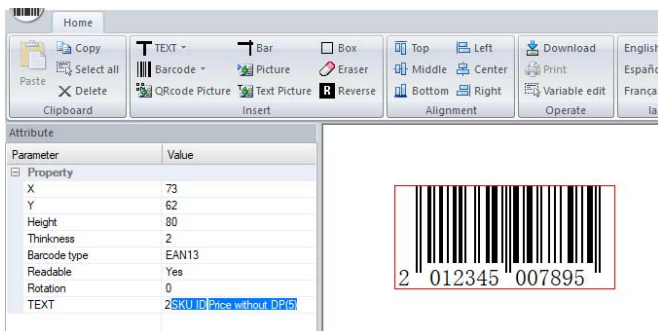

Height: The height of the barcode

Thickness: Minimum line width

Barcode type: Type of barcode (food retailers usually use EAN13)

Readable: Enable or Disable the Print out of the text below the barcode

Rotation: Rotation angle (0 = clockwise)

Text: Can insert this variable (EAN13 barcodes must be numeric and 12 digits long. SKU must be 5 digits long, for price no dot needs to be chosen)

NOTE: if the text for the barcode is entered incorrectly then an error message will appear indicating a wrong entry.



9.1.7 Adding QR Codes

- Left click the QR code icon located in the editing tools section and click on the label area to place the QR code picture. The parameters for the QR code are as follows:

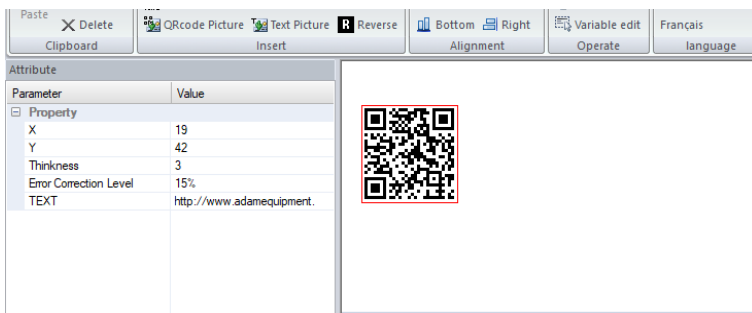

X: 8=1mm, 400=50mm

Y: 8=1mm, 400=50mm

Thickness: The size of the QR code will affect the quality of the QR code. The bigger in size, the easier to scan

Error Correction Level: The bigger the percentage, the easier it is to recover lost print data

Text: The text entered can be a web link or common words so when the QR code is scanned with a smart device it will take the user to the address entered in this parameter.

9.1.8 Deleting items

- Select the item you want to delete by left clicking it and press the delete button on the keypad.

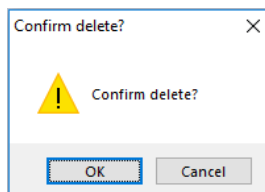

- A message will appear asking the user to confirm the deletion. Press 'OK' to confirm and the item will then be deleted from the label.

- Alternatively, right click the item and click **'delete'**. The same message of confirmation will appear, click **'OK'** to confirm.

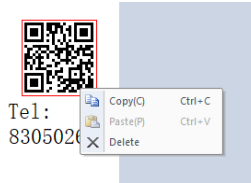

9.2 LABEL DOWNLOAD PROCEDURE VIA RS 232 CABLE

- Save your final label design in preparation for download via RS 232 to the US-X1LP by pressing the save icon located in the top left hand corner of the software
- Export the image by selecting the export icon from the barcode icon in the top left-hand corner
- Press the download icon 
- Select the necessary serial port and baud rate and click **“download”**

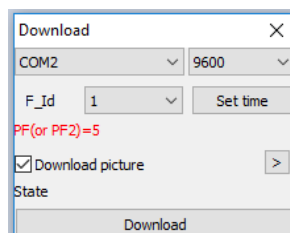

10.0 RS-232 INTERFACE

The US-X1LP Series are supplied with a RS-232 bi-directional interface. The scale when connected to a printer or computer through the RS-232 interface, outputs the weight, unit weight and count.

Specifications:

RS-232 output of weighing data

ASCII code

Adjustable Baud rate, 600, 1200, 2400, 4800, 9600 and 19200 baud

8 data bits

No Parity

Connector:

9 pin D-subminiature socket

Pin 3 Output

Pin 2 Input

Pin 5 Signal Ground

The scale can be set to print text in English, French, German or Spanish. See the RS-232 parameters section for details.

All lines end with line feed <lf>, and carriage return <cr>characters.

Data Format-Normal Output

```
<lf><cr>
<lf><cr>
ID
QTY      0 pcs
U. W     123 g   Kg or g for metric weights and lb for pounds.
G. W     1.234 Kg       Net Wt. if net weight is displayed
Item:                    [barcode]
<lf><cr>                  Includes 2 line feeds with carriage return
<lf><cr>                  at beginning and end of the form
DATE 12/09/2006          TIME 14:56
```

Data Format- Memory Recall Print:

```
<lf><cr>
ID
<lf><cr>
-----
TOTAL
No.      5
Wt.      1.234 Kg
Pcs      10 pcs
<lf><cr>          Includes 1 line feed
-----
<lf><cr>          2 line feeds, carriage return
<lf><cr>
DATE 12/09/2006          TIME 14:56
```

In other languages the format is the same but the text will be in the language selected.

Description	ENGLISH	FRENCH	GERMAN	SPANISH
Item barcode	Item	Article	Artikel	ít
Assigned product/ transaction ID	ID	-	-	-
Product name/ item label	Name	Nom	Name	Nombre
Print gross weight	G. W	Pds Brut	Brut-Gew	Pso Brut
Net weight	N. W	Pds Net	Net-Gew	Pso Net
Weight per unit counted	U. W	Pds unit	Gew/Einh	Pso/Unid
QTY / Number of items counted	Pcs	Pcs	Stck.	Piezas
Number of weighings added to subtotals	No.	Nb.	Anzhl	Num.
Total weight and count printed	Total	Total	Gesamt	Total
Print date	Date	Date	Datum	Fecha
Print time	Time	Heure	Zeit	Hora

10.1 INPUT COMMANDS FORMAT

The scale can be controlled with the following commands. The commands must be sent in upper case letters, i.e. "T" not "t". Press the Enter key of the PC after each command.

T<cr><lf>	Tares the scale to display the net weight. This is the same as pressing [Tare] key. 
Z<cr><lf>	Sets the zero point for all subsequent weighing. The display shows zero. Same as pressing the [Zero →0←] key.
P<cr><lf>	Prints the weight, unit weight and totals same as pressing the [PRINT/SAVE] key.

10.2 REAL TIME CLOCK SETUP

The Real Time Clock (RTC) is used only for the RS-232 output. The Date and Time can be set as required. The scale will keep the clock running even when the power is off.

In weighing mode, Press and hold **[PLU]** key, AND press **[CE]** AT THE SAME TIME for settings. The display will show “**P1 TrA**”, press **[PRINT]** key once, the display will show “**P2 FUN**”.

Press **[PLU]** key again and again to the unit weight display shows “**F9 FAL**”. At this time, press and hold the **[PLU]** key, press **[PRINT]** once, then enter into time setting. The weight window will show “**Date**”, use number keys to input the data information. For example, 11/10/2013, input “**130111**”. Then press **[PLU]** key to enter time setting. The weight window shows “**Time**”, use the numeric keys to input the time information. For example, 10:10, input “**1010**”. Then press **[PLU]** to complete the settings.

Press “ID” to escape and return to normal weighing mode.

10.3 AUTO SLEEP FUNCTION

To set the auto sleep function you will need to enter the ‘Other function’ parameter setting in the User parameters (see section 7).

- Press the **[PLU]** key and the **[CE/ BACKLIGHT]** key at the same time to enter the user parameter setting, the display will show the first parameter “**P1 TRA**”
- Press the **[PRINT/SAVE]** key to move to the other function parameters and press the numeric button **[2]** on the keypad to access the SL parameter.
- Press the **[M+]** key to increase the sleep time in seconds and press the **[Q'TY/PST]** key to confirm.

Press “ID” to escape and return to normal weighing mode.

11.0 BATTERY AND BACKLIGHT OPERATION

11.1 BATTERY

The scales can be operated from the battery, if desired. The battery life is up to 90 hours.

When the battery needs charging the battery symbol will appear.  The battery should be charged as soon as possible. Once the “**LO bAT**” message is shown the scale will still operate for about 10 minutes after which it will automatically switch off to protect the battery.

11.2 CHARGING

When charging, the indicator charge light will appear red. It will turn green when charging finished (the charging time should be 8-10h).

Attention: do not use up the battery, otherwise the battery may break. If the indicator is not in use for a long time, the battery should recharge in 40 days.

After charge, please take off the power supply. We recommend that you do not always connect to the power supply.

11.3 BACKLIGHT FOR LCD

- The backlight of the LCD can be set to be-
“1”: ON at all the time,
“2”: ON only when a weight is placed on the scale or
“3”: Turned off.
- To set the backlight press and hold **[CE/BACKLIGHT]** key for 4 seconds.
- The weight display will show “ON/ OFF/ AUTO”
- Press and hold the **[CE/BACKLIGHT]** key to alternate between these options:

“BL on”	Sets the backlight to be on at all times.
“BL Au”	Sets the backlight to operate automatically when a weight is placed on the scale or a key is pressed.
“BL OFF”	Sets the backlight to be off.

12.0 ERROR CODES

During the initial power-on testing or during operation, the scale may show an error message. The meaning of the error messages is described below.

If an error message is shown, repeat the step that caused the message, turning the balance on, carry out the calibration or other functions. If the error message is still shown contact your dealer for further support.

ERROR CODE	DESCRIPTION	Solution
ADO---	Over A/D resolution range	Remove the weights of the pan or send back to the agent.
ADL---	Over A/D resolution range	Remove the weights of the pan or send back to the agent.
OVR---	Over load (max: capacity +9e)	Check the weight of the weights, cannot exceed Max Cap.+9e
ERR-Z	AD value exceed the power on zero range when power on	Power on again after remove the weights or re-calibrate
Battery symbol flash	Low power alarm	Charge battery
Lo-Bat	Low power alarm	Charge battery

13.0 REPLACEMENT PARTS AND ACCESSORIES

If you need to order any spare parts and accessories, contact USA Measurements or your dealer for the equipment. A partial list of such items is as follows-

Part no.	Name
3.10.4.0.15286	display board
3.10.4.0.15287	printer drive board
3.10.4.8.15288	main board
3.10.4.0.15289	battery 6V10AH
3.10.2.3.15290	printer head roll
3.10.2.0.15291	display panel
3.10.2.3.15292	top housing
3.10.2.3.15293	base housing
3.10.2.3.15296	printer roller
3.10.2.3.15297	printer head set
3.10.2.3.15298	indicator support
3.10.5.6.14715	US-X1LP Count Indicator Overlay
3.10.5.6.14799	US-X1LP model label
3.10.4.0.14808	12V 3A 36W power adapter
302408705	Mains cable figure of 8, UK
302408515	Mains cable figure of 8, Europe
302408514	Mains cable figure of 8, Australia
302408516	Mains cable figure of 8, SA

14.0 SERVICE INFORMATION

This manual covers the details of operation. If you have a problem with the scale that is not directly addressed by this manual then contact your supplier for assistance. In order to provide further assistance, the supplier will need the following information which should be kept ready:

A. Details of your company

- Name of your company:
- Contact person's name:
- Contact telephone, e-mail, fax or any other methods:

B. Details of the unit purchased

(This part of information should always be available for any future correspondence. We suggest you to fill in this form as soon as the unit is received and keep a print-out in your record for ready reference.)

Model name of the scale:	US-X1LP _____
Serial number of the unit:	
Software revision number (Displayed when power is first turned on):	
Date of Purchase:	
Name of the supplier and place:	

C. Brief description of the problem

Include any recent history of the unit. For example:

- Has it been working since it's delivered
- Has it been in contact with water
- Damaged from a fire
- Electrical Storms in the area
- Dropped on the floor, etc.

WARRANTY INFORMATION

USA Measurements offers Limited Warranty (Parts and Labour) for any components that fail due to defects in materials or workmanship. Warranty starts from the date of delivery.

During the warranty period, should any repairs be necessary, the purchaser must inform its supplier or USA Measurements. The company or its authorised Technician reserves the right to repair or replace the components at any of its workshops at no additional cost, depending on the severity of the problems. However, any freight involved in sending the faulty units or parts to the Service Centre should be borne by the purchaser.

The warranty will cease to operate if the equipment is not returned in the original packaging and with correct documentation for a claim to be processed. All claims are at the sole discretion of USA Measurements.

This warranty does not cover equipment where defects or poor performance is due to misuse, accidental damage, exposure to radioactive or corrosive materials, negligence, faulty installation, unauthorised modifications or attempted repair, or failure to observe the requirements and recommendations as given in this User Manual.

This product may include a rechargeable battery that is designed to be removed and replaced by the user. USA Measurements warrants that it will provide a replacement battery if the battery manifests a defect in materials or workmanship during the initial period of use of the product in which the battery is installed.

As with all batteries, the maximum capacity of any battery included in the product will decrease with time or use, and battery cycle life will vary depending on product model, configuration, features, use, and power management settings. A decrease in maximum battery capacity or battery cycle life is not a defect in materials or workmanship, and is not covered by this Limited Warranty.

Repairs carried out under the warranty do not extend the warranty period. Components removed during warranty repairs become company property.

The statutory rights of the purchaser are not affected by this warranty. The terms of this warranty is governed by the US law. For complete details on Warranty Information, see the terms and conditions of sale available on our web-site.